

COSENTINO®

Cosentino Facades

COSENTINO FACADE
FIXING SYSTEMS

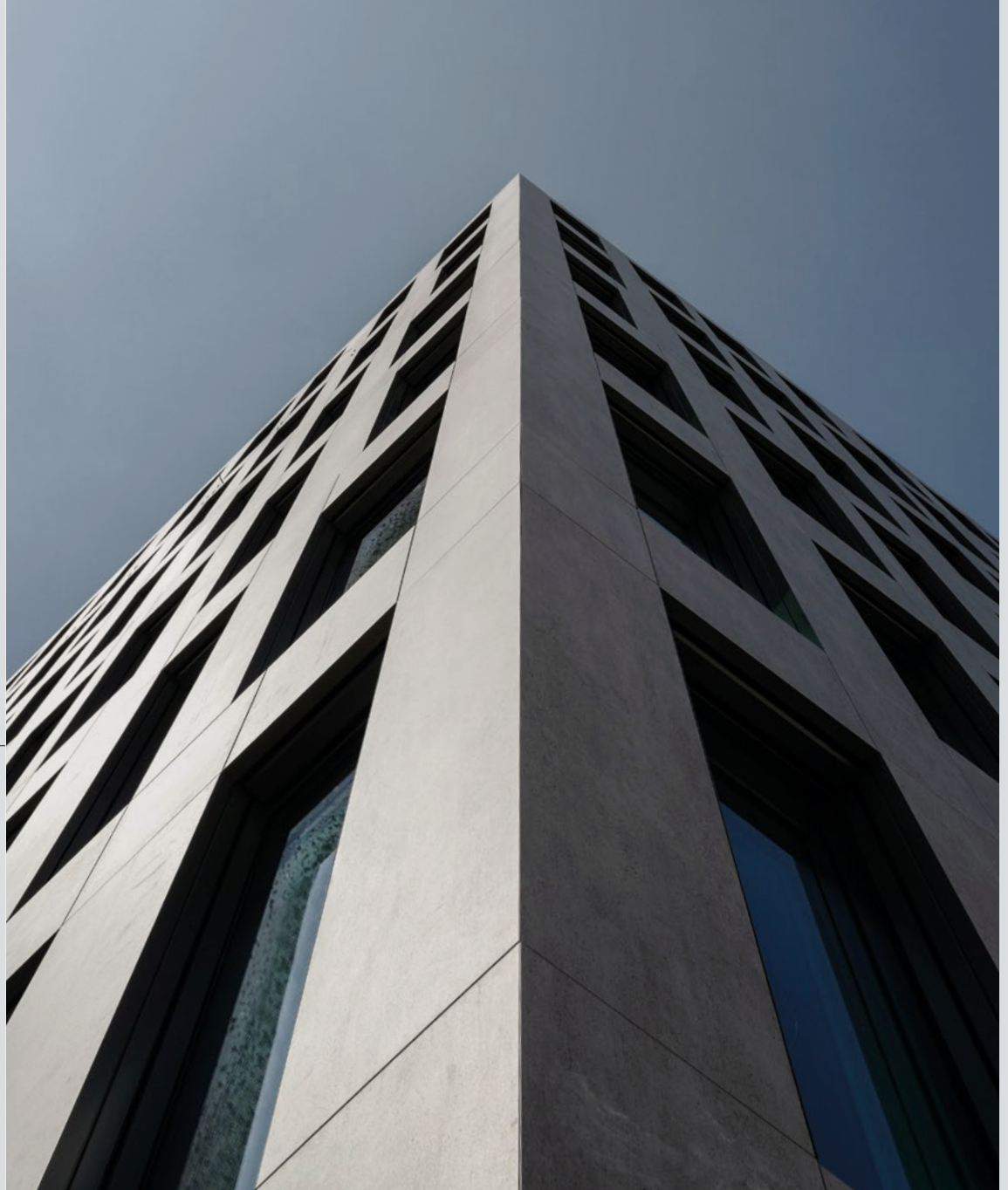

DEKTON®

Content

01 DEKTON® BY COSENTINO	6
Product Description & Characteristics	8
Technical Specifications	16
Sustainability in the factory	18
Certifications	30
02 PRODUCT RANGE	32
Sizes, Formats and Thicknesses	34
Colours and Surfaces	36
Dekton iD	44
Colour Stability	50
Customising Cuts and Special Elements	51
03 CLADDING SYSTEM	56
Ventilated Facades	58
Subframe and Fixing Systems	60
Cladding System	63
Dekton® Corner Solutions	66
04 TYPES OF FIXING	70
DKT1	74
DKT2	108
DKT3	126
DKT4	142
DKBG	154
DKC	180
DKB	196
DKS	206
05 PROCESSING & INSTALLATION	216
Shape Alterations	218
Cutting and Machining	226
Movement of Materials on Site	228
Adhesion	233
Processing	235
Cleaning and Maintenance	236
Contact Details	238
06 PROJECT QUOTATION	240
PSU Technical Services	242
Integral Services for International Projects	245
Dekton® Warranty	250

Dekton[®] by Cosentino

01

- 8 Product Description & Characteristics
- 16 Technical Specifications
- 18 Sustainability in the factory
- 30 Certifications





In the span of a few hours, Dekton emulates what nature took thousands of years to create, thanks to the exclusive TSP Technology.

Product Description & Characteristics

Dekton® is an ultra-compact material, manufactured using a 25,000 ton press (>450 kg/cm²) and a sintering process at around 1,200 °C, with useful dimensions of 3,200 x 1,440 mm, thicknesses of 20 / 12 / 8 and 4mm (it has a safety mesh glued on the reverse for 8, 12 and 20 mm thick ventilated facades and all 4mm thick applications) Fire reaction A2 s1 d0 (according to EN 13501), unaffected by UV radiation ($\Delta E < 1$ tested in Xenon chamber to 5,000 h), with thermal conductivity < 0.5 W/m°C (according to EN 12664), Specific heat < 700 J/kg°C (measured with DSC), Surface resistivity < 65 TΩ/m (at 1000V) and must fulfil these functional mechanical properties according to EN 10545: Bending strength > 45 N/mm², Density > 2,400 KG/m³. Porosity < 0.05%. Linear expansion < 10⁻⁶ °C⁻¹. Suitable for outdoor applications even in aggressive environments (petrol, diesel, various solvents) and can be cleaned with water or other products using pressurised water, with commercial cleaning products or, in the case of persistent stains, specific chemical products (e.g. sulphuric acid, bleach, hydrogen peroxide, acetone, caustic soda).

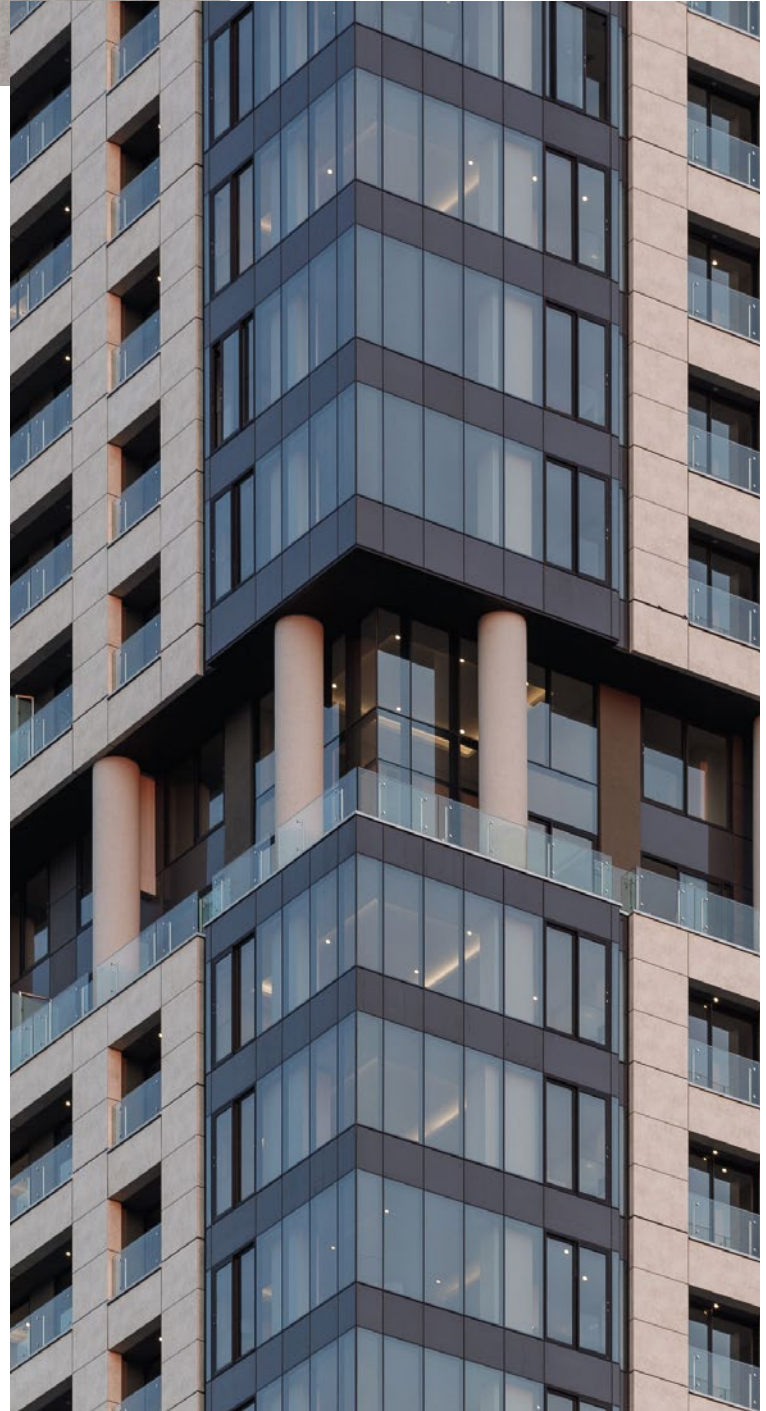

The production takes a number of hours, but a manufacturing plant can produce up to 2,000 slabs a day.

Composition

Dekton® is made from inorganic materials, which naturally exist in over 90% of the Earth's crust.

- Dekton® is a totally inorganic material.
- Dekton® uses inorganic materials not only for the bulk of the product but also for pigmentation and veining.
- More than 20 different inorganic materials are used to create a Dekton® slab.



Production

Dekton® uses exclusive TSP Technology (Sinterized Particle Technology), a high tech process which represents an accelerated version of the metamorphic change that natural stone undergoes when subjected to high temperatures and pressure over thousands of years. TSP technology synthesises truly innovative procedures from the most advanced technology industries. This evolution represents a technological and industrial leap capable of generating a new process, a revolutionary material and a leading product.

The production takes a number of hours, but a manufacturing plant can produce up to 2,000 slabs a day . From start to finish the process includes the following steps:

1. Decontamintaion of the raw materials.
2. Mixing of materials.
3. Addition of pigments
4. Distribution of material on conveyor belts.
5. Volume decoration process.
6. Compaction.
7. Drying and secondary decoration.
8. Sintering.

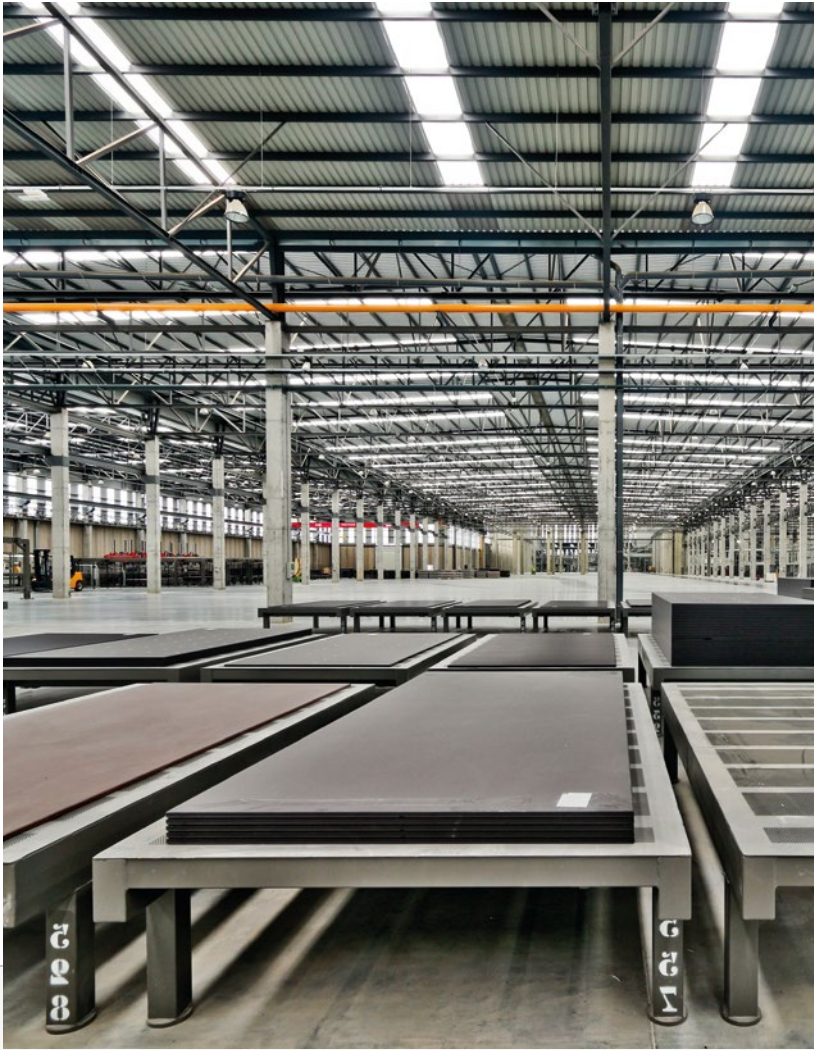

Compaction

Compaction using a unique press made specifically to manufacture ultra-compact panels. Panels are pressed at 25,000 cubic tons (50,000,000 lb.). This compaction helps to align particles to achieve zero-porosity by forcing air and moisture out, hence the need for the homogeneous particle sizes. Superficial textures (slate, wood, leather, linen, etc...) can also be added during the compaction stage.

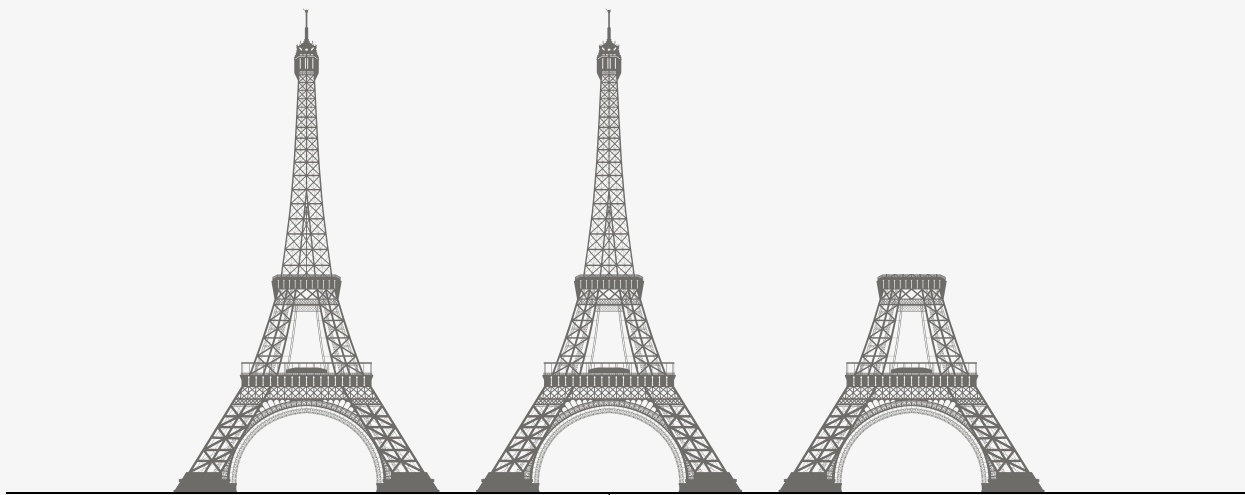

Two and a half Eiffel Towers = 25,000 cubic tons (50,000,000 lbs)

Ultra-compact surface panel

Sintering process

During this process, the transformation of the raw materials and pigments takes place. By using heat, reactions are controlled so that the correct synthesis path is followed.

- The kiln is 200 metres (218 yards) long.
- Temperatures reach approximately 1250°C (2300 °F).
- The total process time depends on the thickness of the slab (around 4 hours).

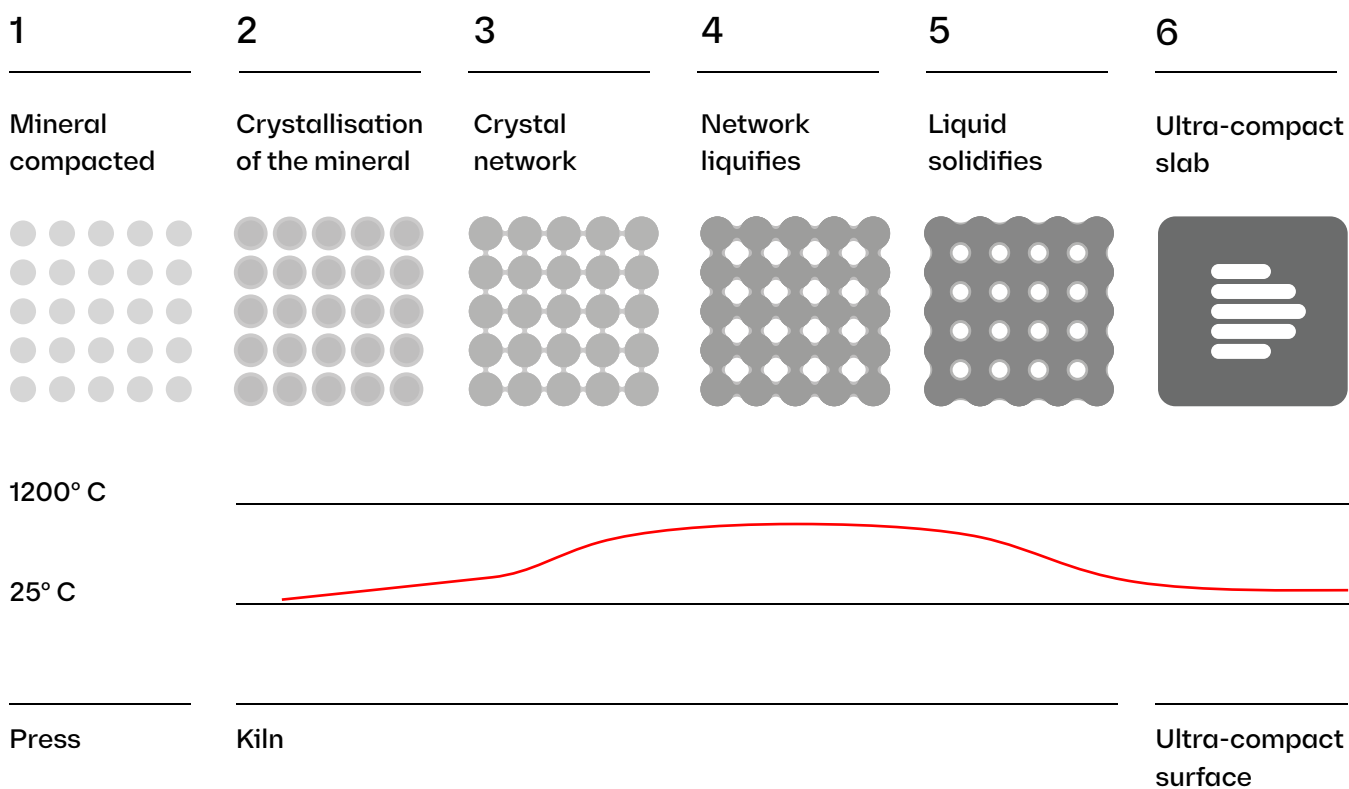

Mesh

The mesh on the reverse of Dekton® is applied at the Cosentino factory, developed especially for ventilated facades to prevent fragments in the event of breakage, as safety is a main concern of Cosentino. It is a fibreglass mesh 300 gr/m2 and glued with an epoxy resin.

Standard applications

Dekton® is a material suitable for multiple applications, both interior and exterior, in different scales and with infinite design possibilities.



**Outdoor
worktops**



**Kitchen
worktops**



**Flooring for
bathrooms and pools**



**Exterior walls
& façades**



**Bathroom
surfaces**



**Outdoor
flooring**



**Interior
walls**



**Bathroom
walls**



**Indoor
floors**

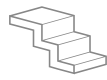

Stairs

Some facade applications

- Ventilated facades.
- Adhere facades.
- Cladding on EIFS systems.
- Facades of industrialized systems.
- Curtain wall.
- Cladding for window and door apertures.
- Facade complements.

Product features

Dekton® has all the technical features required for any hard surface, even in a demanding application such as a facade.



Fireproof material

Dekton® can withstand high temperatures without burning, scorching or cracking. European Standard EN 13501 and ASTM E84 testing, classifies Dekton® as a noncombustible material.



Highly resistant to ultraviolet (UV) light

Dekton® is highly resistant to UV light and will not fade or degrade over time in any kind of outdoor application.



Superior mechanical resistance

Dekton's® variety of thicknesses allow it to be used in applications where resistance to wind or impact are a project requirement.



Low water absorption

Dekton's® water absorption is negligible so it does not undergo any expansion movement due to it.



Colour durability

Dekton's® control of pigmentation and decoration in the manufacturing process provides better colour consistency from one slab to another, resulting in a long lasting product that will not fade over time.



Scratch resistant

Dekton® is one of the most scratch-resistant surfaces on the market.



Dimensional stability

Dekton® expansion is minimal so it can be installed with thin joints between panels. These joints will keep their width in all conditions.



Resistance to freezing and thawing

Dekton® resistance to durability tests in freezing and thawing situations and its application in various weather conditions prove its high performance.



Abrasion resistant

Dekton® is even more resistant to abrasion than granite and porcelain, making it the ideal surface for facades or high-traffic flooring in commercial applications.



Maximum fire and heat resistance

Dekton® has been successfully installed on facades in areas exposed to high temperatures.



Easy cleaning and low maintenance

Most graffiti can be removed from Dekton® with standard cleaning products. Maintenance costs are reduced.



Stain resistant

Dekton® is resistant to stains from a variety of sources so they can easily be removed without altering their finish.

Advantages of Dekton® facade system

Dekton® offers clear advantages in its application on facades.

1 Large format

Thanks to Dekton®'s large format of up to 3200 x 1440 mm, it gives freedom to the design of the facade and the ability to use different formats in order to make the best use of the material.

2 Wide range of thicknesses

The variety of Dekton® thicknesses available, 4, 8, 12 and 20 mm, allows you to apply thicker or thinner pieces as required. This maintains the consistency of the whole and gives each section the required technical features.

3 Colour perfection

Thanks to a rigorous system of measurements and quality controls from its production onwards, Dekton® ensures the stability of its tone throughout the façade, making it possible to use the material in large panels while maintaining visual harmony.

4 Endless design and colour possibilities

The variety of Dekton® colours allows for a wide range to be used as another design tool, maintaining uniformity and character.

5 Adaptation to complex geometric shapes

The possibility to produce Dekton® in simple or complex pieces makes it a versatile material for covering complicated volumes.

6 Flat surfaces: visual continuity

The excellent flatness offered by Dekton® ensures that façade surfaces are virtually free of any gaps. This means that it is ideal for promoting design around it, where visual continuity and uniformity are key.

7 Solutions for joints

Dekton® allows for angled joints with straight or bevelled edges, and even with bespoke pieces to create a monolithic look, thanks to its resistance to expansion.

8 Unlimited shapes

Architectural plans with different gradients and complex geometrics can push materials to their limits. Few of them can work under traction and compression in the face of inclement weather and remain unchanged and requiring little maintenance over time.

9 Uniform colour

Dekton® is coloured throughout the whole mass of the product allowing better integration of the edges with the surface of the piece.

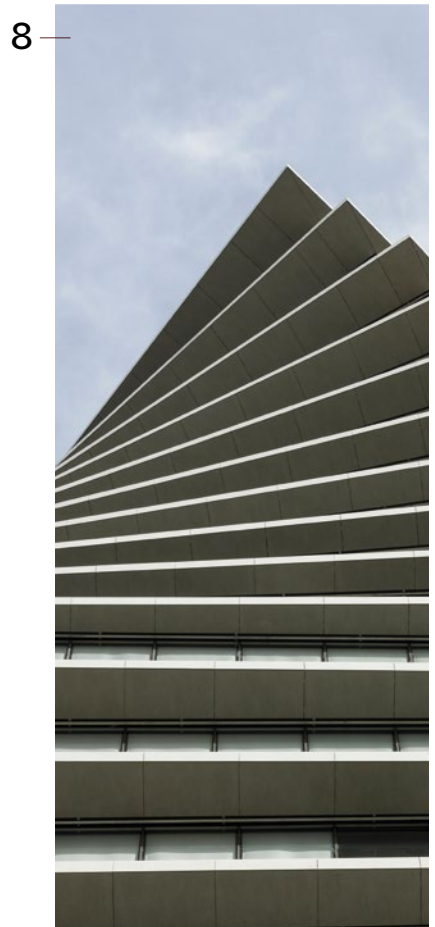
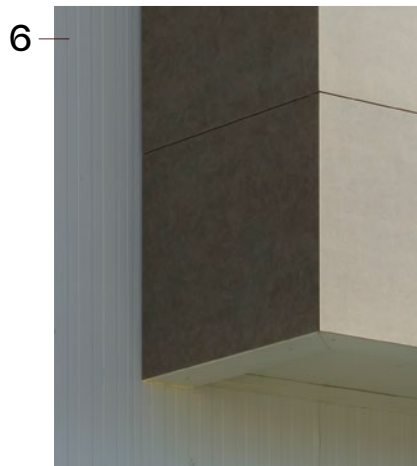
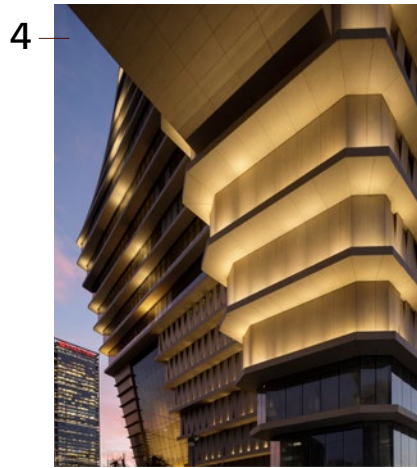
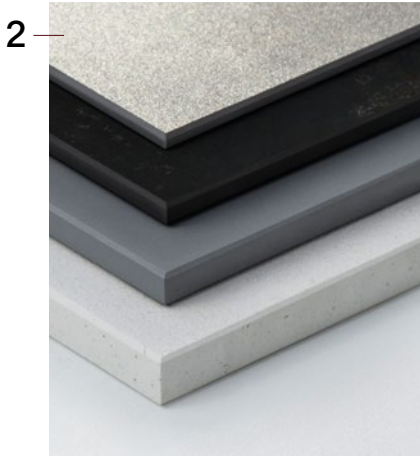

Technical specifications

Key technical data

- Density $2.52 \pm 4 \%$ g/cm³
- Average bending strength ≥ 45 N/mm²
- Modulus of elasticity: 84,000 N/mm²
- Linear thermal expansion $5.9 \times 10^{-6} \text{ } ^\circ\text{C}^{-1}$
- Water absorption 0.1%. (Bla Group)
- Porosity 0.2%.
- Maximum expansion 0.1 mm/m.
- Thermal conductivity 0.483 W/m °K
- Reaction to fire. A1/A2 s1 d0 (with mesh)
EN 13501-1 2018 and NFPA/
IBC class A ASTM E 84.



Technical characteristics

According to standard EN-14411

TEST STANDARD	DECISION	UNIT	FAMILY I	FAMILY II	FAMILY III	FAMILY IV
Bending strength and breaking load ISO 10545-4	Average bending strength	N/mm ²	46	45	55	46
	Average breaking load	N	2,548	2,313	2,356	2,568
	Average breakage force	N	14,966	13,559	13,818	15,620
Water absorption, open porosity and densities ISO 10545-3	Boiling water absorption	%	0	0.1	0.1	0.1
	Vacuum water absorption	%	0.1	0.1	0.1	0.1
	Open porosity	%	0.2	0.2	0.2	0.2
	Apparent relative density	g/cm ³	2.51	2.61	2.53	2.44
	Apparent density	g/cm ³	2.50	2.61	2.52	2.44
Deep abrasion resistance ISO 10545-6	Abraded volume	mm ³	125	106	115	119
Determination of dimensions and surface appearance ISO 10545-2	Length and width	%	0.11/-0.18	0.04/-0.08	0.04/-0.04	0.02/-0.02
	Thickness	%	0.50/-0.50	4.95/-2.20	0.53/-0.53	-1
	Straightness of sides	%	0.01/-0.01	0.03/-0.03	0.01/-0.03	0.02/-0.02
	Orthogonality	%	0.07/-0.16	0.04/-0.09	0.21/-0.21	0.08/-0.08
	Centre curvature	%	0.04/-0.08	-0.06	-0.06	-0.07
	Edge curvature	%	0.06/-0.06	0.02/-0.04	0.02/-0.04	0.02/-0.02
	Warping	%	-0.11	-0.07	-0.06	-0.04
	Surface appearance (Tiles default)	%	100	100	100	100
Determination of impact resistance ISO 10545-5	Average coefficient of restitution	-	0.85	0.85	0.85	0.92
Determination of linear thermal expansion ISO 10545-8	Expansion between 30-100°	°C ⁻¹	6.5·10 ⁻⁶	5.1·10 ⁻⁶	6.3·10 ⁻⁶	5.8·10 ⁻⁶
Determination of thermal shock resistance ISO 10545-9	Damage	-	Pass/no damage	Pass/no damage	Pass/no damage	Pass/no damage
Determination of moisture expansion ISO 10545-10	Maximum expansion	mm/m	0.1	0.1	0.1	0.1
	Medium expansion	mm/m	0.0	0.0	0.0	0.1
Determination of frost resistance ISO 10545-12	Damage	-	Pass/no damage	Pass/no damage	Pass/no damage	Pass/no damage
	CINH ₂ /Cleaning products	Class	A (no damage)	A (no damage)	A (no damage)	
	Bleach/Pool salts	Class	A (no damage)	A (no damage)	A (no damage)	
	HCl (3% v/v)	Class	LA (no damage)	LA (no damage)	LA (no damage)	
	Citric Acid (100g/l)	Class	LA (no damage)	LA (no damage)	LA (no damage)	
	KOH (30 g/l)	Class	HA (no damage)	HA (no damage)	HA (no damage)	
	HCl (18%)	Class	HA (no damage)	HA (no damage)	HA (no damage)	
	Lactic Acid (5%)	Class	HA (no damage)	HA (no damage)	HA (no damage)	
KOH (100 g/l)	Class	HA (no damage)	HA (no damage)	HA (no damage)		
Determination of chemical resistance ISO 10545-13	Green staining agent	Class	5	5	5	5
	Red staining agent	Class	-	-	-	-
	Iodine (solution)	Class	5	5	5	5
	Olive oil	Class	5	5	5	5

Sustainability in the factory

Cosentino S.A., in line with sustainable development and its policy of continuous improvement, has in recent years developed a series of investments for the environmental improvement of the production process. These actions are aimed at eliminating or reducing air emissions from industrial installations, implementing water treatment systems in order to optimise its use and minimise spillages, improving waste management and minimising its generation. Investments have also been made in sustainable mobility, energy efficiency and creating green spaces. To achieve the highest levels of sustainability in the production of Dekton®, the best available techniques (BATs) have been used, representing a total investment exceeding 14 million euros.

Within the Cosentino sustainability policy, sustainable mobility plays a prominent role. In view of this, and associated with the new industrial park where Dekton® is produced, over 2 kilometres of bike lanes have been designed and bicycles have been purchased to allow employees to travel around the site. This has meant an investment is over 50,000 euros. In addition, sustainable mobility is also promoted on the industrial park, with the use of electric vehicles, for both workers and suppliers.

Sustainability in the factory

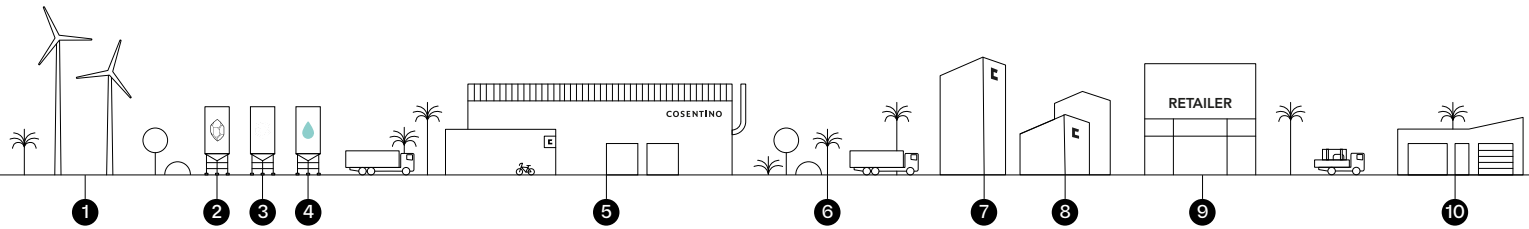

- 1 100% certified renewable energy
- 2 Raw materials
- 3 Recycled raw materials
- 4 99% recycled water
- 5 Factory
- 6 +94,000 m² Green spaces
- 7 Cosentino City
- 8 Cosentino Center
- 9 Stonemason, kitchen and bathroom shops, architects and designers
- 10 Final customer



We produce 1.45 million m² of products containing recovered or recycled materials
Recovery of 33% of the waste generated



Use 19% more recycled water than in 2018



We promote sustainability
Products with up to 25 years warranty



Our sustainable mobility strategy avoided 1,255 tons emissions of CO₂ equivalent per year in 2019



Dekton® products represents the emission of 14.54 kg of CO₂ per m², 11% less than in 2018



Agreements signed with shipping companies
In 2019 we have avoided the emission of 4,000 tons of CO₂ equivalent



We renewed the ISO 14001:2015.

The data provided refers to activities at the Cantoria Industrial Park in 2019 (Almeria, Spain)

Atmosphere

Air protection is essential not only at an environmental level but also for the health of people. Among the measures adopted in the manufacturing of Dekton[®], the following stand out:

- Airtight transport systems for micronised raw materials from the lorry to the mill. These prevent the emission of dust particles into the atmosphere, preventing their dispersion, cross-contamination and achieving a better use of them.
- Integrated transport systems to minimise the potential emissions from the point of generating the coloured raw material (atomisers) to the point of storage (24 airtight silos). These systems have dust extraction, they streamline the route, belts and particularly unloading and transfers among belts to reach the deposit silos. With all this, the natural resource consumption is optimised by increasing the efficiency of its use, minimising industrial waste generation by 95%.
- Centralised dust collection and purification systems, through 7 bag filters, are located in different sections of the factory. Bag filters are highly efficient devices that purify 99% of the emitted dust.
- Four electric vehicles that transport the product throughout the factory and from Silestone 3 to the automated distribution centre. These vehicles do not consume fuel (which means a significant reduction in emissions compared to diesel engines) and have an energy saving system.
- Installation for vacuum, treatment and recovery of the fumes from the kilns. This system can redirect the fumes from the kilns to the atomisers, using their heat and thus, reducing natural gas consumption and air emissions. Natural gas consumption is reduced by 10% compared to conventional installations and their corresponding CO₂ emissions.
- MRD and SPR heat recovery systems in the kilns. These systems recover some of the heat from the cooling zone of the furnace to preheat the combustion air. Natural gas consumption is reduced by 5%, with the consequent decrease in atmospheric emissions linked to its combustion.

ATMOSPHERIC
EMISSIONS

**Carbon Footprint Calculation
of the Organisation (2019)**

**Localised Projects for
CO2 emissions reduction
(2019 onwards)**

**Strategic Plan for reducing,
compensating and neutralising
emissions (2020)**

Waste Recovery

The following systems have been installed for the recovery of waste generated in the production process:

- Several installations designed to reuse raw waste prior to the decoction process. It includes the raw waste recovery line, a transport and loading freight line to the turbo-crushers and dissolution installation. If these installations had not been implemented, industrial waste amounting to approximately 5% of daily production would be generated, but with this equipment, this industrial waste will be reprocessed, minimising this amount of waste by 90%. This equipment has cost more than 1.2 million euros.
- Dust recovery system from the different emission catchment areas. This dust is reused as a raw material in the process. More than 500,000 euros have been invested into these systems.
- Sweeper-scrubber cleaning machine with water recycling system. The main objectives of this machine are to minimise airborne dust caused by passing vehicles and maintain all facilities with optimum cleanliness levels. This type of machine can improve uncontrolled waste management and minimise 95% of consumption of flushing water for cleaning compared to a traditional system. 70,000 euros have been invested in the machine.

WASTE VALORISATION

Since 2018, we have our own

- Non-hazardous Waste Management Company



- Waste Management and Valorisation Plant

By using our own facilities we avoid the emission of more than 7,000 tonnes of CO₂e/year from the transport of waste.

33% Overall
Waste Valorisation

Evolution

2018-19	2025	2050
30%	50%	100%

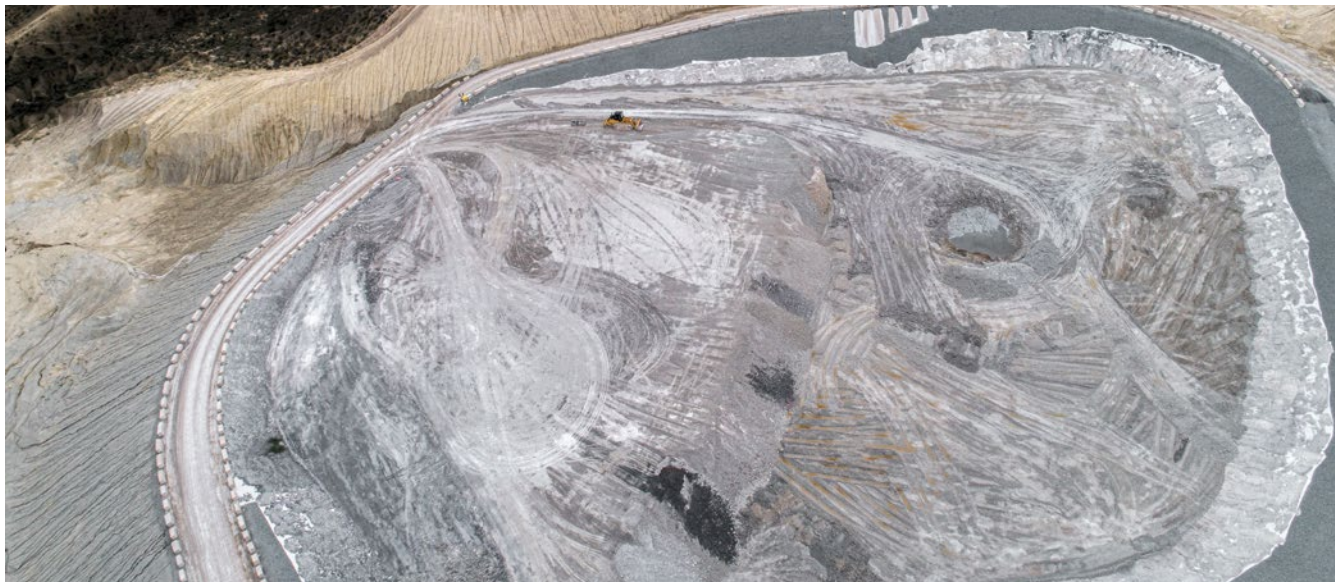

Management and use of water

Water is a limited resource, especially in an arid region such as the South-east of Spain. This has been taken into account in the manufacturing of Dekton®, applying the following measures:

- Four tanks located at different points in the factory that allow the collection of clean water and its reuse in the process. This installation prevents the generation of 50% of clean water being handled as waste. 250,000 euros have been invested in these installations.
- Technological water system by reverse osmosis. Aimed at the production of 300 m³ /d of technological water from the water supply, with a rejection flow of technological water less than 5% of incoming water.
- A water decanting and clarification system that allows the treatment and recovery of process water (95% recovery). Along with the technological water system, it involves an expenditure of 1 million euros.
- Automatic cleaning systems for atomisers. These systems only apply the water strictly necessary for such cleaning, minimising the generation of waste flows in the process that requires further treatment (for reuse in the process) or external management of waste. In addition, there is no need to lower the temperature of these systems while cleaning, so there is higher temperature maintenance than the traditional method (i.e. manual cleaning by operators) and therefore lower energy consumption (minimizing atmospheric emissions from gas consumption) to return machinery to its operating temperature. Investment over 32,000 euros.

WATER RESOURCES CONSUMPTION 2019

262 thousand m³/year

- Industrial water (reservoir)
222 thousand m³/year*
*Subsequent replacement with tertiary treated water (WWTP)
- Sanitary water (tap)
40 thousand m³/year

60 thousand m³/year reused water for irrigation

82 million m³/year treated and reused in process

Evolution

2016	2019	2020	2025
WWTP (8)	99% of residual water recycled in the process	Tertiary WWTP	Feasibility study on a desalination plant



Green Spaces

More than 25,000 m² of green spaces have been installed in the new industrial park. Local species have been used and more than 200 trees, that are adapted to the arid conditions of the area. More than 250,000 euros have been invested in these new spaces.



Energy Efficiency

Apart from the already mentioned saving measures (such as reusing the heat from the kilns), other efficiency measures have been programmed. LED lighting has been used for exterior areas, with time adjustment linked to traffic. Maximum use of natural light with skylights has been used for lighting the interior of the factories.

ENERGY CONSUMPTION

100% electricity from renewable sources

0% CO₂ eq./year Indirect emissions

30% self sufficient energy supply in 2020

Expected Evolution

2021	2022	2025	2030
Photovoltaic plant 20 MW ISO 50.001	WWTP (8) Feasibility Study for Wind turbine generation plant	Feasibility Study for alternative fuels	New photovoltaic plant

Cosentino CO₂ Neutral

We have identified those projects that meet the characteristics needed to make responsible compensation, and that have a strong social component that supports the achievement of the Sustainable Development objectives of UN Agenda 2030.

The project chosen in 2019 for offsetting emissions has a significant social impact on sustainable development by supporting the local economy through training and employment creation.

ZERO EMISSIONS STRATEGY

The ultra-compact Dekton® surface is classified as Carbon Neutral.

We offset our CO₂ emissions over the entire product life cycle.

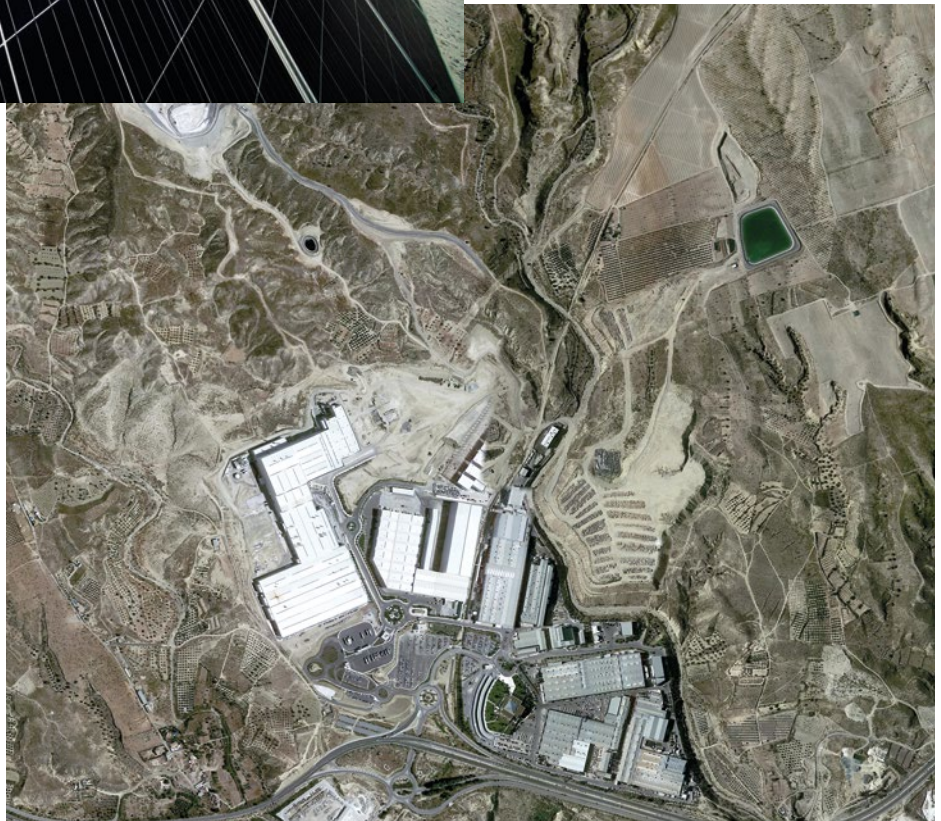

Carbon Footprint

One of the main milestones in 2019 has been the initial calculation of our organisation's carbon footprint. The carbon footprint has been calculated based on the company's results from 2018, taking into account both direct emissions from sources monitored by the organisation in its activity (scope 1), and indirect emissions from purchasing electricity (scope 2), as well as other indirect emissions that mostly come from the extraction and provision of raw materials by our suppliers (scope 3). This means we have been able to identify the points in the process where the most emissions are created and their impact is greatest. As a next step, for 2020 we will have a tool that enables us to define goals for reducing, offsetting and neutralising GHG emissions and energy consumption, focusing on the short, medium and long term. These goals will be included in the Cosentino Group's "Strategic Plan for reducing, offsetting and neutralising CO₂ emissions" (currently under development). This document will not only contain the company's strategic direction, but also the carbon footprint calculations from 2019.

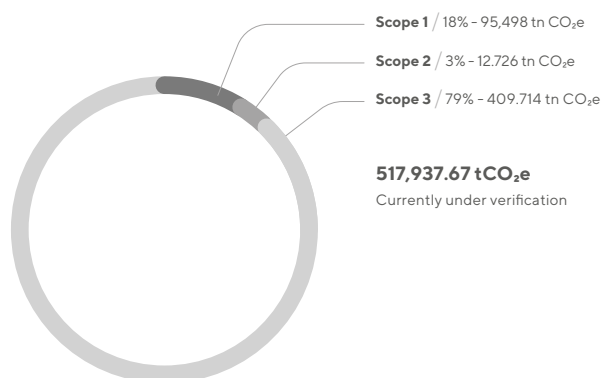

CARBON FOOTPRINT

ACTIONS

With the projects and measures currently underway, it estimates an annual reduction in CO₂ emissions of 15,500 tons/year:

- Process improvement plan / Efic. Energy
- Emissions compensation projects.

It is necessary to involve the entire value chain:

- ISO 20400 sustainable purchases. Tool to audit and value our suppliers.
- Large-scale compensation project, involving suppliers.

Expected Evolution

Short Term

2020-21

Sustainable Mobility Plan.

Projects for reduction, compensation and neutralisation of emissions.

Mid-Long Term

2021 onwards

Feasibility study for progressive replacement of natural gas with biofuels.

Feasibility Study for CO₂ capture and storage.

Environmental Product Declaration



This document contains the Dekton® Construction Environmental Product Declaration (EPD)® and the results of its Life Cycle Analysis (LCA), which was completed 28/06/2016. This EPD is intended both for industrial customers as well as end users. This study was conducted in order to understand the environmental impact of this worktop throughout its entire life-cycle (from cradle to grave). In other words, the results reflect the analysis of the production, transportation, and installation stages, use and end of life. Other aims of this study are the implementation of a systematic process of continuous improvement for all the phases of this cycle and to publish an Environmental Product Declaration (EPD) with the results obtained. This study was conducted according to the following standards:

1. General programme instructions for the International EPD® System (Rev. 2.5 2015/05/11).
2. Product Category Rules (PCR) for preparing an environmental product declaration (EPD®) for product group “Construction products and CPC 54 construction services” (Multiple UN CPC codes 2012:01 Construction Products and Construction Services (version 2.1).

EPD®_SYSTEM

- EPD N°. S-P-00916 / Environmental Product Declaration according to ISO 14025 and EN 15804
- Date completed: 01/10/2016 / Validity: 5 years / Valid until: 01/10/2021
- Based on PCR 2012:01 Construction Products and Construction Services version 2.1
- Geographical scope of the EPD: International

Description of stages of the system

PRODUCT STAGE	CONSTRUCTION STAGE		USER STAGE					END OF LIFE STAGE				BENEFITS & BURDENS OUTSIDE THE LIMITS OF THE SYSTEM				
A1. Raw Materials	A2. Transportation	A3. Production	A4. Transportation	A5. Installation	B1. Use	B2. Maintenance	B3. Repairation	B4. Substitution	B5. Rehabilitation	B6. Energy Use	B7. Water Use	C1. Demolition	C2. Transportation	C3. Waste Treatment	C4. Waste Disposal	D. Reuse, Recycling & Recovery
X	X	X	X	X	X	X	X	X	X	X	X	X	X	X	X	X

X: included; MND: Module not declared

All the values in these tables are related to the functional unit of the study (one ton of product). Tables 5, 6 and 7 describe the environmental performance, use of resources and waste management of Dekton, always expressed in values per functional unit. None of the materials used for Dekton are on the 'Candidate List of Substances of Very High Concern' (<http://echa.europa.eu/es/candidatelist-table>).

The units, indicators of environmental impact and the conversion factors used are those set out in 'Appendix A of the MSR 1999:2' (Rev.1.1 dated 2005/9/25) and those set out in the CML-IA 3.0 methodology (<http://cml.leiden.edu/software/data-cmlia.htm>) for calculating environmental impact. This methodology is fully developed and used at a European level thanks to the reliability of its data and its scientific bases which are supported in the methodology and procedures set out by Guinée et al. (2001). To calculate the primary renewable energy consumed, the Cumulative Energy Demand (CED) methodology developed by Frischknecht et al. has been used. (2007).

The impact categories calculated are in accordance with those set out in Multiple UN CPC codes 2012:01 Construction Products and Construction Services (version 2.1) and the results were divided depending on the stages and modules described in section 4. The latest available version of SimaPro software (SimaPro 8.0.3.) was used to calculate this data. The calculated impacts are potential and always consider standard operating conditions.

Environmental performance per functional unit

PARAMETERS	PRODUCT	CONSTRUC		USER STAGE							END OF LIFE STAGE				D. REUSE, RECYCLING & RECOVERY
	STAGE	TION STAGE													
	A1 - A2 - A3	A1. Transportation	A2. Installation	B1. Use	B2. Maintenance	B3. Repairation	B4. Substitution	B5. Rehabilitation	B6. Energy Use	B7. Water Use	C1. Demolition	C2. Transportation	C3. Waste Treatment	C4. Waste Disposal	
Abiotic resources depletion (elements) (kg Sb eq.)	1.7E-03	1.83E-07	0	0	1.13E-08	0	0	0	0	5.80E-10	0	1.2E-09	0	2.38E-08	-1.2E-04
Abiotic resources depletion (fossil fuels) (MJ.)	1.8E+04	1.93E-03	0	0	1.95E-01	0	0	0	0	2.87E-02	0	1.2E+01	0	5.45E+01	-1.8E+01
Global Warming (kg CO ₂ eq.)	1.2E+03	1.48E-02	0	0	1.33E-00	0	0	0	0	1.92E-03	0	9.4E-01	0	4.00E+00	-1.3E+00
Ozone depletion (kg CFC eq.)	1.4E-04	2.19E-05	0	0	1.28E-07	0	0	0	0	1.85E-10	0	1.4E-07	0	2.57E-07	-2.0E-07
Photochemical Oxidation (kg C2H4 eq.)	1.8E-01	2.71E-02	0	0	2.08E-04	0	0	0	0	3.89E-07	0	7.3E-05	0	5.14E-04	-4.8E-04
Acidification (kg SO ₂ eq.)	3.4E+00	8.07E-01	0	0	4.81E-03	0	0	0	0	9.22E-06	0	2.5E-03	0	2.00E-02	-8.2E-03
Eutrophication (kg PO4 eq.)	3.4E+01	1.07E-01	-	-	3.84E-03	-	-	-	-	9.31E-07	-	4.8E-04	-	4.24E-03	-6.8E-04

Unit = 1000 kg of Dekton

A building is energy efficient when it is designed to minimise the amount of conventional energy used on a daily basis.

Dekton® Feroe

Energy Efficiency: Leed and Breeam

The sustainability of architectural projects has gone from being an interesting and desirable addition, to representing a real need that must be considered from the very beginning of the design stage. A building or infrastructure will be sustainable as long as it complies with different criteria, from its impact on the environment where it is located, to the origin of the materials used in its construction.

A building is energy efficient when it is designed to minimise the amount of conventional energy used on a daily basis. It is not just about saving on the energy bill. There are many other benefits to this approach: easier fitting of materials, lower maintenance costs and reduced obsolescence and material degradation. In order to undertake the construction of a sustainable energy building, two types of strategy must be developed: passive design strategies, focused on taking advantage of the climate and the environment in which the building is located; and active design strategies, such as the use of different renewable energy sources to supply the building.



LEED

LEED (Leadership in Energy and Environmental Design) is the most widely used sustainable building rating system in the world. LEED provides a framework for classifying eco-friendly and highly energy-efficient buildings, and is available for almost all types of architectural projects. When constructing a building, taking into consideration LEED certification is key to reducing costs before, during and after the project.



Sustainable sites

To minimise effects on microclimates, humans and wildlife by reducing heat islands. Using material in non roof applications with a $RS \geq 0,33$ and in roof application with $RSI \geq 82$ or $RSI \geq 39$ (depending on slope). You can get 2 Leed Credits as Dekton solar reflectance (RS) and solar reflectance index are.

SR= 0,462 grey colours
SR= 0,674 cream colours
SR= 0,790 white colours

SRI= 52 grey colours
SRI= 81 cream colours
SRI= 98 white colours



Regional priority

Regional priority credits (RP) are those existing LEED credits that help project teams focus on their local priorities in terms of environment, social equity and public health. Requirements: One credit is awarded for each Regional Priority credit achieved, up to a maximum of four.

Cosentino is a company with a growing global presence. It currently distributes its products and brands in more than 80 countries, using its own distribution channel in 37 of them. This is key to understanding and meeting the regional priorities for each project.



Material and resources

To encourage the use of products and materials for which life-cycle information is available and that have preferable environmental, economical, and social life-cycle impacts. You can get 1 Leed credit as Dekton has its own environmental product declaration and the carbon footprint reduction plan is in development.

Requirements: To use products from at least five different manufacturers that meet at least one of the following responsible sourcing and extraction criteria. The total value of the construction products used in the project that meet these criteria must represent at least 40% of the total value of construction products permanently installed in the project. You can get 1 Leed credit because Dekton Trillium and Radium uses up to 80% of reused materials, Eter up to 30% and white range has various percentages of reused materials.



Innovation

To encourage building teams to achieve exceptional and innovative efficiency Requirements: To excel in innovation beyond the elements listed in the LEED guide.

You can get from 1 to 5 Leed credits as Innovation is part of Cosentino's DNA. As a leading company, Cosentino innovates and anticipates solutions, together with its clients and partners, that offer design, value, and inspiration to people's lives.



Indoor environmental quality

To provide a comfortable thermal environment that supports and promotes occupant productivity and well-being. Requirements: To meet all requirements for both design and technical comfort control. To design the building envelope in order to meet either ASHRAE Standard 55- 2017 or ISO 7730:2005 requirements.

You can get 1 Leed Credit because Dekton is certified for its use in ventilated facade.

To use materials inside the building (and within the waterproofing membrane) to meet the low emission criteria listed below. a. FLOORING: At least 90% of the total cost of the flooring installed meets the VOC content requirements. b. WALLS: At least 75% of the total costs of the walls installed meets the VOC content requirements.

Yo can get 1 Leed Credit as Dekton is Greenguard Gold certified.

BREEAM

BREEAM is one of the most important and recognised sustainability certifications in the world. It focuses on assessing the environmental impact of all types of architectural projects. BREEAM assesses impacts in ten different categories ranging from ecological land-use to the use of sustainable materials and infrastructures and buildings energy efficiency. BREEAM encourages the development of projects from a sustainable approach that generates economic, environmental and social benefits for all those involved in the construction and subsequent use of the building or infrastructure.



Cosentino designs its materials from an innovative and sustainable approach that helps architects and designers to meet the requirements of the BREEAM evaluation system. Both the design of the products and the materials used in their manufacture are focused on guaranteeing the lowest environmental impact on each architectural project. In this sense, the energy efficiency of buildings using Cosentino materials in their construction is particularly relevant.



Health and well-being

HEA 02 Indoor air quality.

To encourage a healthy internal environment through the specification and installation of appropriate ventilation, equipment and finishes. Requirements: Volatile Organic Compound (VOC) emission levels. The selected products must comply with the emission limits specified in the guide.

You can get 1 Breeam credit as Dekton® is Greenguard Gold certified.

HEA 04 Thermal Comfort.

To ensure, through design, both the achievement of comfortable temperature and the necessary control devices to maintain a thermally comfortable environment for the building's occupants.

You can get 1 Breeam credit as Dekton is certified for facade use.



Materials

MAT 01 Life cycle impact.

To encourage the use of construction materials with a low environmental impact over the full life cycle of the building. Requirements: At least five products specified at Design Stage (DS1) and installed by the Post-Construction Stage (PCS 2) are covered by verified Environmental Product Declaration.

You can get 1 Breeam credit as Dekton® is EPD certified.

MAT 06 Material efficiency.

To recognise and encourage measures to optimise efficiency of materials. Material efficiency: "...This includes using fewer materials, reusing existing demolition and dismantled materials and, where appropriate, procuring materials with higher levels of recycled content..."

You can get 1 Breeam credit as Dekton® uses different percentages of recovered materials in some of its colours: - Dekton Trilium and Radium, up to 80% - Dekton Eter, up to 30% - White range, various percentages.



Innovation

INN 01 Innovation.

To support innovation within the construction industry through the recognition of sustainability related benefits which are not rewarded by standard BREEAM issues. Requirements: Up to a maximum of 10 credits are available, with the total BREEAM score capped at 100%, in aggregate from a combination of the following: a) 1.c Indoor air quality: All product types comply with the emission limits, test requirements and additional requirements listed in the guide. (1 CREDIT) b) 1.g At least 10 products specified at Design Stage (DS) and installed by the Post-Construction Stage (PCS) are covered by the manufacturer's verified Environmental Product Declaration (1 CREDIT).

You can get these points as Dekton® is Greenguard gold and EPD certified.

Certifications

Dekton® is in the process of certification of the following worldwide certifications with environmental implications.

ISO 9001



Cosentino has been found to conform to the Quality Management System standard: ISO 9001:2015. This certificate is valid for design, manufacturing, production, distribution, sales and marketing of Dekton® ultra-compacted surfaces.

ISO 14001



This recognition certifies and consolidates the quality of the Cosentino Environmental Management System. This certificate covers the entire process in which the company is involved in from the design, manufacture and processing of Dekton®, to its distribution and marketing. It certifies, among other aspects, the efficient use of raw materials, control of emissions into the atmosphere, waste management programmes, treatment systems and re-use of industrial water, disposal of chemical substances, and control of environmental hazards.

DGNB LABEL



Dekton® has been uploaded to the DGNB Navigator, that gives Cosentino in Germany an optimal support in defining relevant product characteristics and providing the corresponding parameters. They can also make use of predefined performance specifications, which include a step-by-step description of the product features that are relevant in applying DGNB sustainable building criteria in their product category. It provides links to the information page of each of your products in the Navigator – giving interested parties direct access to the information they are looking for.

ETA 14/0413



It is a European technical approval based on EAD 090062-00-0404 “Mechanically Fastened Exterior Facade Cladding Kits”. It is a reference document for application in Europe and other markets. It includes technical data for three different ventilated facade systems for 12 and 20 mm. DKT1 for undercut anchor system and DKT2 and DKT3 for edge grooving systems with continuous profile or clips.

NOA



NOA certificate has been approved and designed to comply with the Florida Building code including the High Velocity Hurricane Zone. It includes two types of systems, with Dekton® 12mm installed on aluminium profiles and hangers fixed to plywood attached to wooden battens, steel stud framing or masonry, and Dekton® 8 mm installed with an adhere system. It includes test reports about static air pressure, cyclic wind pressure loading, flame spread and smoke generation, freeze and thaw cycles and water absorption.

NSF



NSF is an independent non-profit organisation devoted to safety in public health and environmental protection. NSF is a worldwide leader, in the development of standards, product certifications, education and risk management for health and public safety. Different Dekton® products are being tested and assessed by NSF under international standard 51. Obtaining the NSF certification and thus, the right to use the logo for the certified products, entails a toxicological evaluation of the ingredients of all the different products, proficiency testing and successfully passing unannounced audits annually, on all manufacturing sites.

* To obtain more information about hues with NSF certificate please visit www.nsf.org

BBA 16/5346



This Agreement certifies Dekton® relating to ventilated cladding for fixing to an aluminium support subframe, and for use as a drained and ventilated façade on external masonry, concrete or steel frame walls of new and existing buildings.

Greenguard



Greenguard Environmental Institute is a non-profit organisation whose mission is to protect public health and improve quality of life through programmes that improve air quality indoors. Some studies by the Environmental Protection Agency in the USA have proved that indoor air contamination can be 100 times higher to outdoor contamination levels.

In energy efficient constructions, pollutants tend to become trapped in living spaces instead of moving freely in the environment. Some of the most harmful contaminants indoors are Volatile Organic Compounds (VOCs), carbon monoxide, particles from cooking and nitrogen oxide. These contaminants can cause sick building syndrome, which causes dizziness, nausea and related illnesses.

Dekton® has been analysed by Greenguard, proving that it does not emit any type of VOC and thus has achieved Greenguard Certified (Certificate No. 41572-410) and Greenguard Gold (Certificate No. 41572-420) Certifications.

NCREE Earthquakes

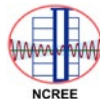

Reports on seismic testing issued by the National Center for Research on Earthquake Engineering in Taiwan (NCREE), a seismic simulation laboratory.

Other product certifications

EPD



HPD



IMO

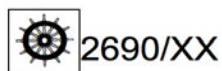

Coc (Civil Defence)



VOC Eurofins



DoP



Kosher



Incombustible



A1/A2 s1 d0 (with mesh)
EN 13501-1 2018 y NFPA/
IBC class A ASTM E 84

Product Range

02

- 34 Sizes, Formats and Thicknesses
- 36 Colours and Surfaces
- 44 Dekton iD
- 50 Colour Stability
- 51 Customising Cuts and Special Elements



Sizes, Formats and Thicknesses

Standard size

Thanks to the size and lightness of Dekton® 3,200 x 1,440 mm (with the possibility to cut to size), the design possibilities are growing exponentially.

Formats recommended to maximise use of Dekton®

Thickness (cm)	Format (cm)
0.4	71 x 71
	71 x 142
	142 x 142
0.8	79 x 143
1.2	106 x 71
	106 x 143
2	159 x 71
	159 x 143
	144 x 320
	71 x 320



	142 x 142	144 x 320	143 x 159	143 x 106	143 x 79
71 x 71	71 x 142	71 x 320	71 x 159	71 x 106	

Standard thicknesses

Dekton® slabs come in different thicknesses so that you choose the most appropriate option depending on the application, design or desired effect, from 4 to 20 mm

Standard size

Thanks to the size and the lightness of Dekton® 3,200 x 1,440 mm (with the possibility to cut to size), the design possibilities are growing exponentially.

Surface Textures

- **Matt:** Smooth without shine
- **Velvet:** Textured
- **Polished:** Shiny



Measurements, weight and tolerances

Thickness (mm)	Weight (Kg/sqm)	Weight (Kg/slab)
4	10.1	46.44
8	20.2	92.89
12	30.2	139.34
20	50.4	232.24

Tolerances

- Thickness ± 0.5 mm.
- Length and width ± 2 mm.
- Perpendicularity ± 2 mm.
- Straightness of the sides ± 1.5 mm.
- Centerline curvature ± 2 mm.
- Lateral curvature ± 2 mm.
- Warping ± 2 mm.

Technical features

- Density: $2,52 \pm 4 \%$ g/cm³
- Bending strength: ≥ 45 N/mm²
- Modulus of elasticity: 84,000 N/mm²
- Linear thermal expansion: $5.9 \times 10^{-6} \text{ }^\circ\text{C}^{-1}$
- Water absorption: 0.1%. (Grupo Bla)
- Porosity: 0.2 %.
- Maximum expansion: 0.1 mm/m.
- Thermal conductivity: 0.483 W/m²K
- Reaction to fire: A1/A2 s1 d0 (with mesh) EN 13501-1 2018 and NFPA/IBC class A ASTM E 84

Colours and Surfaces

Types of Patterns

We have classified our range of colours into three different clusters of patterns to facilitate the design process. All our portfolio is labeled as Infinite Pattern, Singular Pattern and Smooth Pattern, depending on the effect desired for large surfaces and the placement of slabs adjacent to one another, taking into account the directionality of the design, shades and variations.

However this classification is merely indicative and we recommend that you go to our Product to obtain an individual assessment that guarantees how you can materialize your project the way you imagined.



Infinite Pattern

Plain colours or designs with a uniform or quasi-uniform composition and structure that, when used for coverings such as floors, walls, or facades, allows for the random placement of boards and cut-outs achieving total visual homogeneity. Recommended for large surfaces.



ToHa by Ron Arad and Avner Yashar. Tel Aviv, Israel

Singular Pattern

Designs with chromatic ranges of greater complexity and very marked directionality, which result in patterns with a lot of character and variation in smaller pieces and adjacent placements. We recommend that you consult our advisors for use on large surface claddings.



Armonk Professional Center. New York City. USA



Dekton® Kovik 8mm. DKB Facade System

Smooth Pattern

Designs with a directionality in the graphic structure that has to be taken into account when cutting and placing adjacent boards, either if continuity in the holistic design is sought or otherwise. It is a very versatile type of pattern but it requires the placement and cutting of boards accordingly. Recommended for large surfaces.

Dekton® Bookmatch

From some of our designs, we have created unique, symmetrical and interchangeable references that allow compositions and designs to be made where the veins have continuity between different pieces.

There is a system of numbers and letters to select the patterns that best suit your needs according to available colour and thickness.

Material on request, check availability.

Dekton® Slim Aura 15

Available thickness:
4mm

Dekton® Natura 18

Available thicknesses:
4, 8, 12, 20 mm



Dekton® Aura 15

Available thicknesses:
8, 12, 20 mm

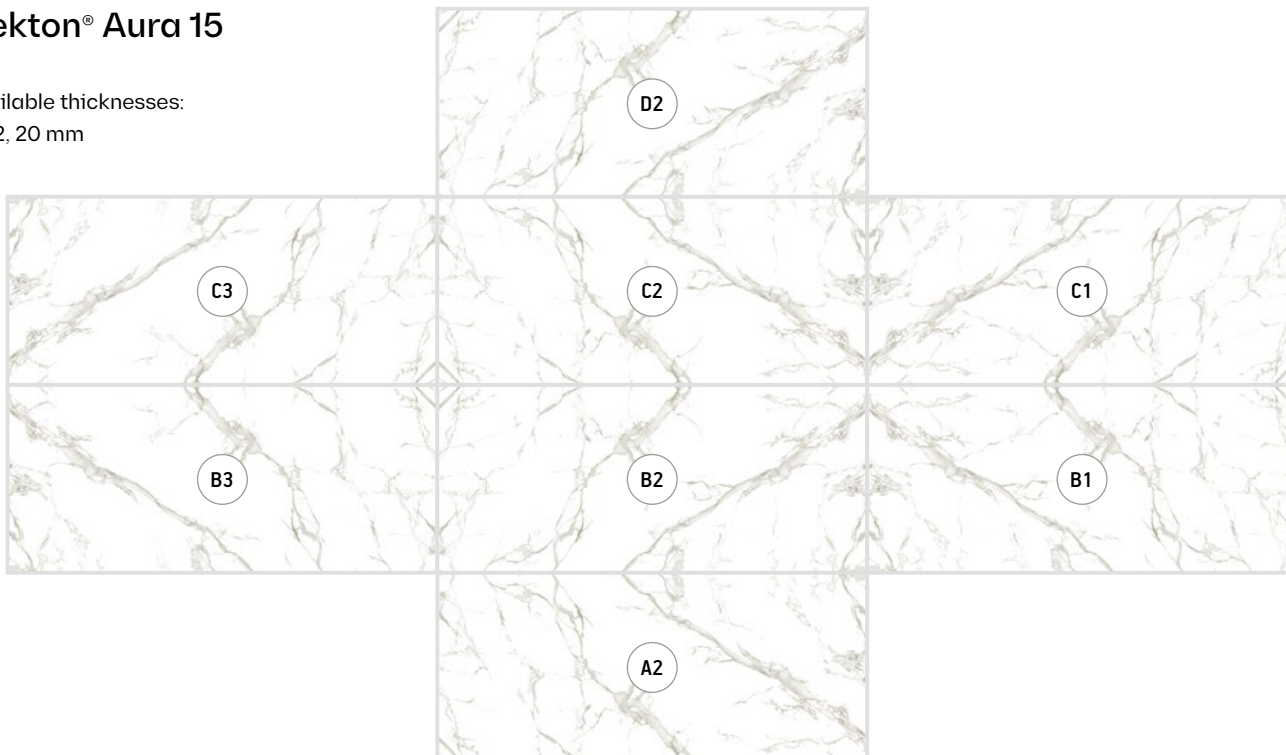

CASE STUDY

444N Orleans Building

Chicago, USA

Material

Dekton® Aura Bookmatch

Thickness

12mm

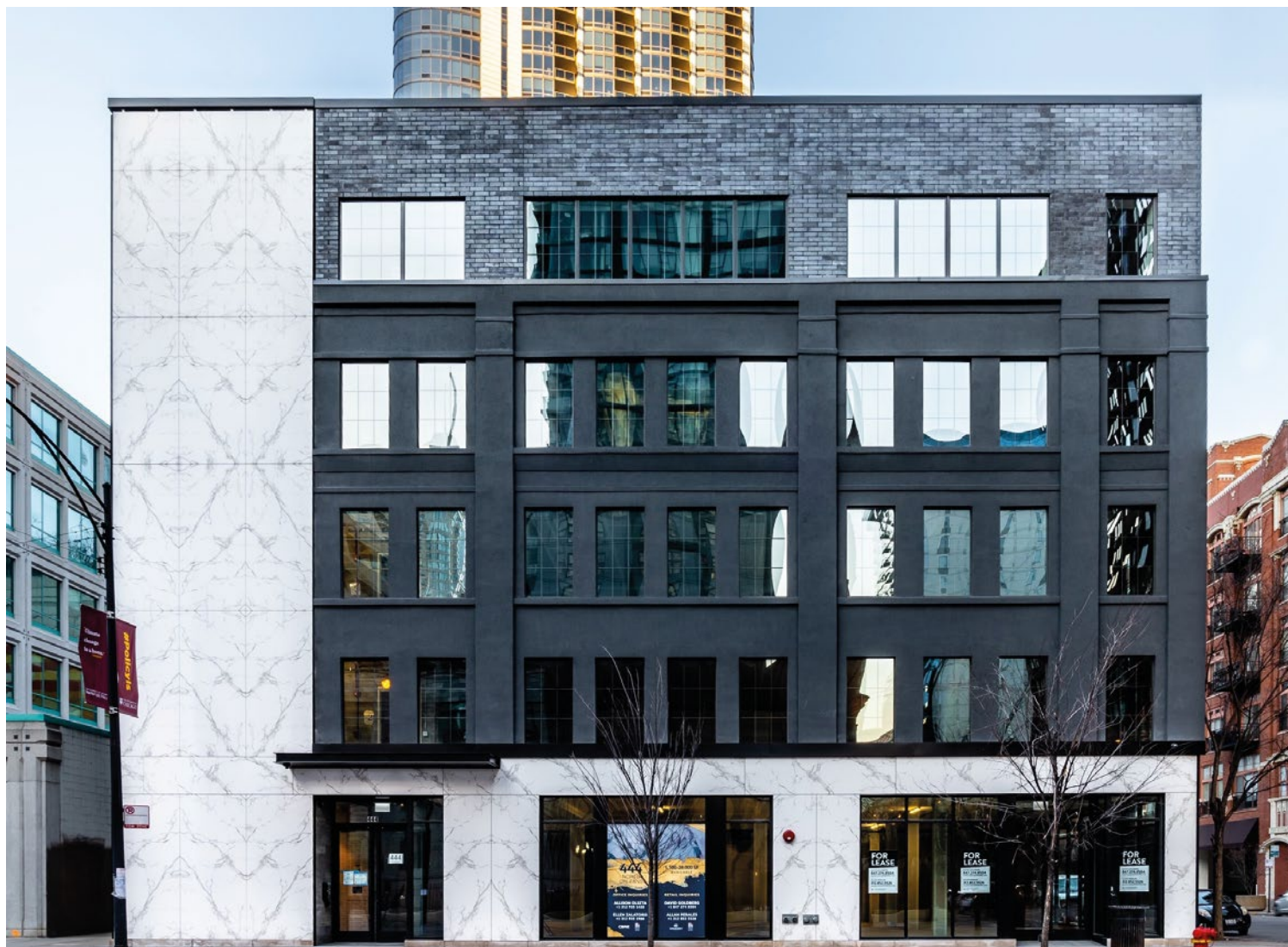

Colour Chart, Patterns and Finishes

Infinite Pattern

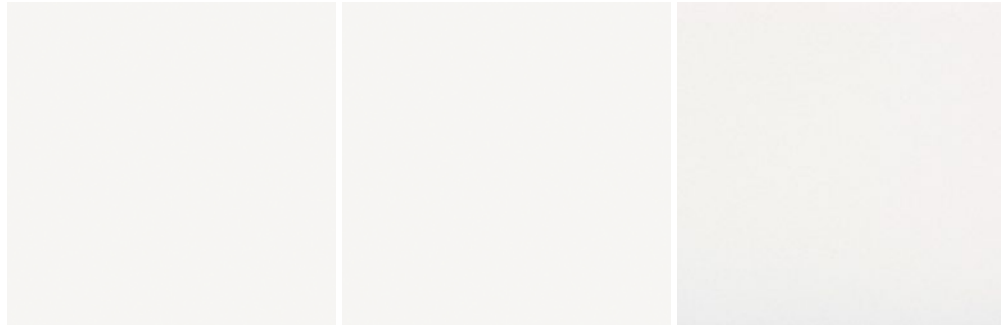

Uyuni Chromica [icon] [icon]

Zenith SOLID Collection [icon] [icon]

Halo XGLOSS Solid [icon] [icon]

Nayla NATURAL Collection [icon] [icon] [icon]



Vienna XGLOSS Basiq [icon]



Blanc Concrete TECH Collection [icon]



Aeri NATURAL Collection [icon]

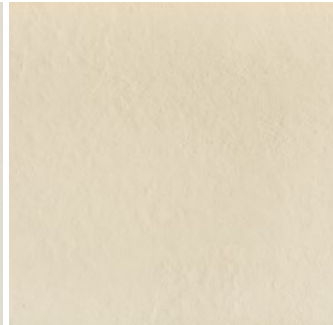

Edora NATURAL Collection [icon] [icon]



Sasea NATURAL Collection [icon] [icon]

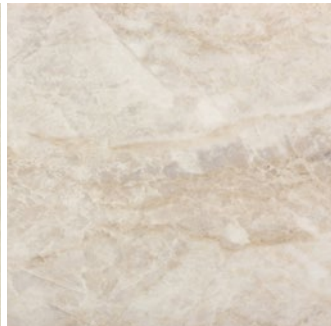

Arga STONIKA Collection [icon]



Keon TECH Collection [icon] [icon]



Galema SOLID Collection [icon]



Strato TECH Collection [icon] [icon]



Sirocco NATURAL Collection [icon] [icon] [icon]



Milar INDUSTRIAL Collection [icon]

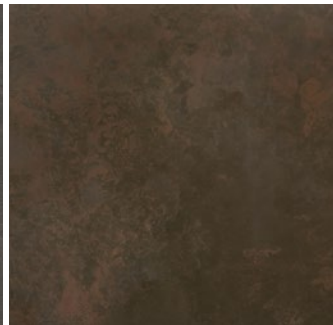

Keranium TECH Collection [icon]



 Ultra Texture
  Ultra Matt
  Velvet Texture
  XGloss
  Eco Dekton
  Dekton Slim 4mm
  Thickness 3cm

Singular Pattern



Bromo NATURAL Collection  



Baltic* Chromica  



Feroe* Chromica Collection  

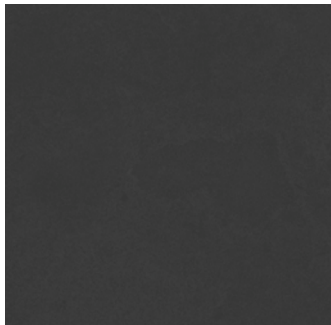

Eter NATURAL Collection 

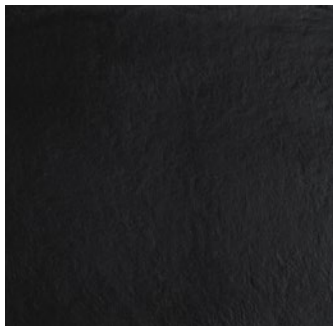

Sirius SOLID Collection  

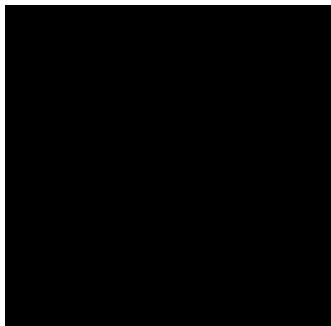

Domoos SOLID Collection 

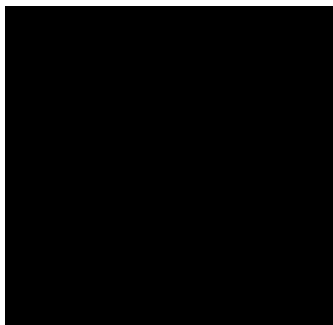

Spectra XGLOSS Solid 



Aura 15 NATURAL Collection   



Rem NATURAL Collection 



Natura 18 XGLOSS Natural 



Opera NATURAL Collection  



Kairos NATURAL Collection 

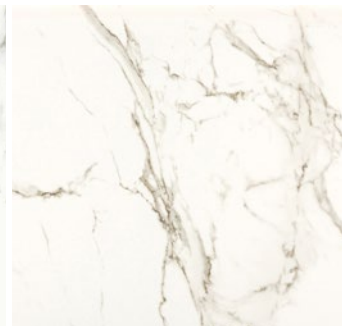



Entzo NATURAL Collection 



Sky LIQUID Collection 



Nilium INDUSTRIAL Collection  

*Special orders. Subject to availability of material.

Singular Pattern



Olimpo STONIKA ✳



Helena STONIKA ✳



Bergen STONIKA ✳ ⬇



Tundra 19 XGLOSS Natural ✳



Portum NATURAL Collection ☼



Shell LIQUID Collection ☼



Khalo STONIKA ✳



Soke INDUSTRIAL Collection ☼ ☼



Vera NATURAL Collection ☼ ☼



Orix INDUSTRIAL Collection ☼ ☼



Tritium INDUSTRIAL Collection ☼ ☼ ☼ ⬇



Laos INDUSTRIAL Collection ☼ ☼ ⬇



Radium INDUSTRIAL Collection ☼ ☼

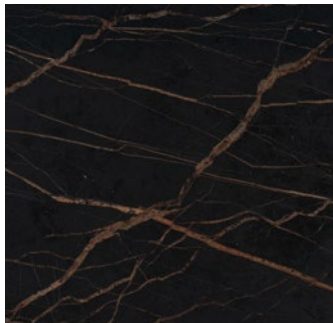

Laurent NATURAL Collection ☼

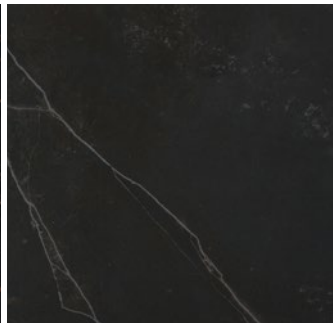





Kelya NATURAL Collection ☼ ⬇

 Ultra Texture
  Ultra Matt
  Velvet Texture
  XGloss
  Eco Dekton
  Dekton Slim 4mm
  Thickness 3cm

Smooth Pattern





Lunar INDUSTRIAL Collection   



Makai WILD Collection  

Danae NATURAL Collection  



Taga STONIKA Collection 



Kovik NATURAL Collection  

Kreta INDUSTRIAL Collection   

Sogne STONIKA 

Kira NATURAL Collection  



Korso STONIKA Collection 

Fossil NATURAL Collection 

Embers LIQUID Collection 

In the following colours belonging to the category of SINGULAR and SMOOTH patterns, the directionality of the texture, as well as the movement of the background, must be taken into account at the time of cutting. Colours: Arga, Aura15, Bergen, Blanc Concrete, Bromo, Danae, Entzo, Fiord, Glacier, Kairos, Kelya, Keon, Khalo, Kira, Korso, Makai, Natura 18, Nillium, Laos, Laurent, Olimpo, Opera, Orix, Portum, Radium, Rem, Soke, Sogne, Taga, Trilium, Tundra 19, Vera.

Dekton iD

From printing specific graphics in any colour to changing texture, to creating a completely original design that includes custom colours, textures and finishes, keeping the benefits of Dekton® unchanged.

Two different levels of customisation to suit each project

Dekton iD is a breakthrough service by Cosentino that enables the possibility to customise our Dekton® products.

DEKTON iD
INDIVIDUALLY DESIGNED



DEKTON ID PRO

From 1000 sqm

Combine any of our colour bases.
Choose one of our textures.
Print a design like patterns,
graphics or even your brand.

1 Base colour selection

The first step is the selection of the base colour. You can choose any colour available from the wide range of Dekton®.

Base colour

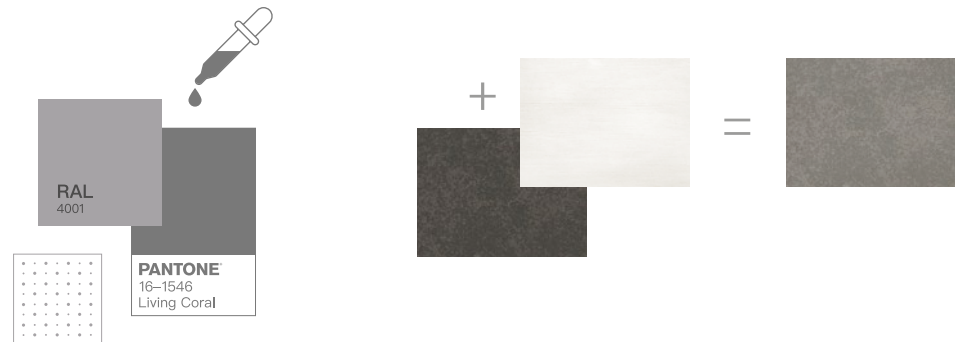

2 Design application onto Dekton® surfaces

You can apply countless customised designs to Dekton® surfaces, as well as colours and grades that will transform its appearance.

Design

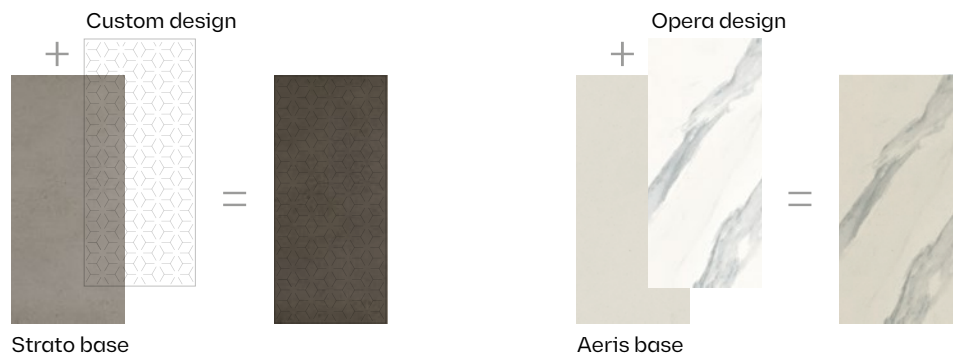

3 Texture selection

The different textures available, such as matt, ultra-gloss, wood and slate, to name a few, will provide the finish with attractive nuances and a unique feel to the touch.

4 Thickness selection

While Dekton® standard thicknesses are 4, 8, 12, 20 and 30 mm.

5 Cutting

Dekton® large format slabs can be cut to size, regardless of the shape.

Textures

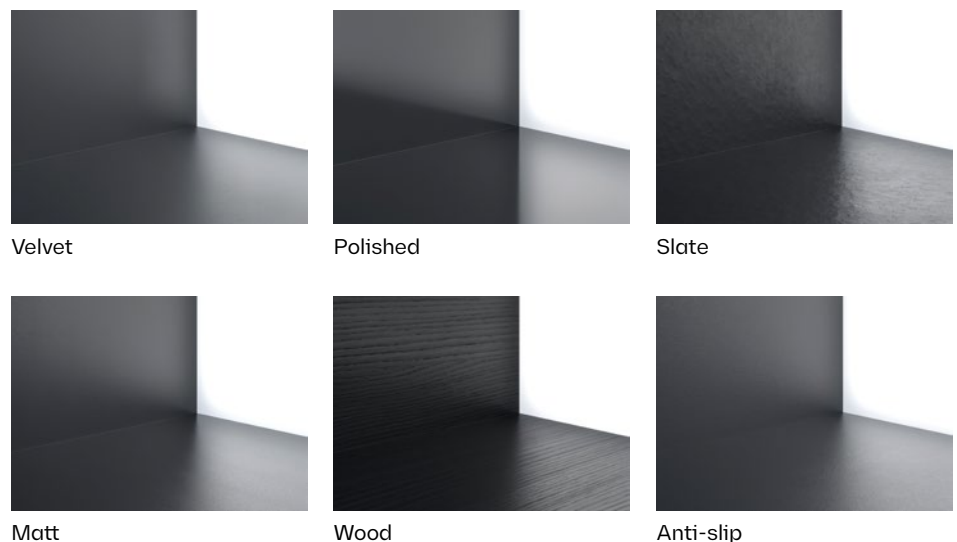

DEKTON iD UNLIMITED

From 2500 sqm

Create your fully personalised colour, texture and finish from scratch. Even the colour bases, texture, finishes, formats and much more.

1 Base Colour

The customer sends the Dekton iD team his/her initial idea: it can be a colour or the image or photo that sparked the customer's inspiration. From that moment, the Dekton iD team will perform a series of tests to achieve the desired colour. Meanwhile, the customer will be receiving samples and can adapt the product to his/her preferences.

2 Designs

You can apply countless customised designs to Dekton® surfaces, as well as colours and grades that will transform its appearance.

3 Textures

The different textures available, such as matt, ultra-gloss, wood and slate, to name a few, will provide the finish with attractive nuances and a unique feel to the touch.

4 Effects

Additional finishes that provide, selective gloss, pearlescent effects and unique inks, creating light base-relief, among others.

Thanks to the effects, it is possible to create all kinds of visual sensations to enhance a texture or colour, providing a very original final design.

5 Thickness

While Dekton® standard thicknesses are 4, 8, 12, 20 and 30 mm, Dekton iD Pro allows you to create specific thicknesses to suit the requirements of each project.

6 Cutting

Dekton® large format slabs can be cut to size, regardless of the shape.

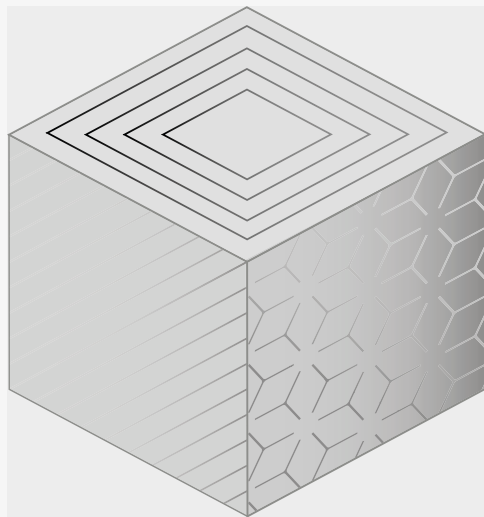

Thickness

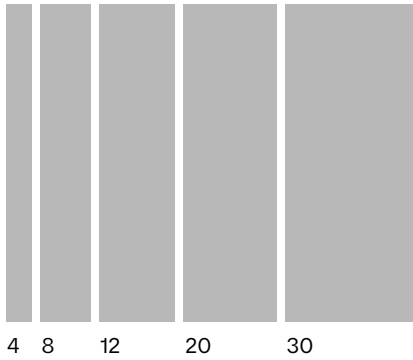

Cutting



Effects



Selective relief



Base relief



Vivid Colours



Copper



Brass

Basic Workflow



Send us your idea

Send your idea to customdk@cosentino.com and start from scratch customising its colour, texture and format thanks to Dekton ID.

Or release your creativity on Dekton surfaces with the help of Dekton ID Unlimited. You can check the project's development either through the samples that you will receive from Cosentino, or personally, through visiting Cosentino's facilities.



Personalised advice

Cosentino's R+D team will help you with your project, supporting you at every step of the process:

From the initial idea, to the features and creative possibilities of Dekton®.



We bring your vision to life

Dekton ID's aim is clear: to achieve a perfect, customised result just like you imagined it.

DEKTON ID

INDIVIDUALLY DESIGNED

CASE STUDY

ToHa by Ron Arad and Avner Yashar

Tel Aviv, Israel

Material

28,000 m² of Strato and 6 Dekton ID colours

Thickness

12 and 20 mm

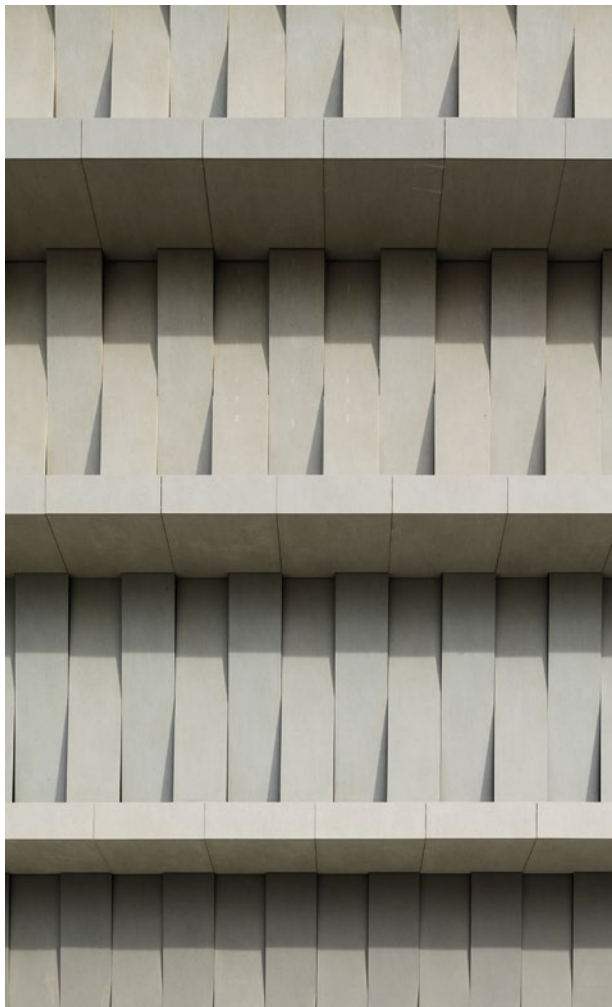
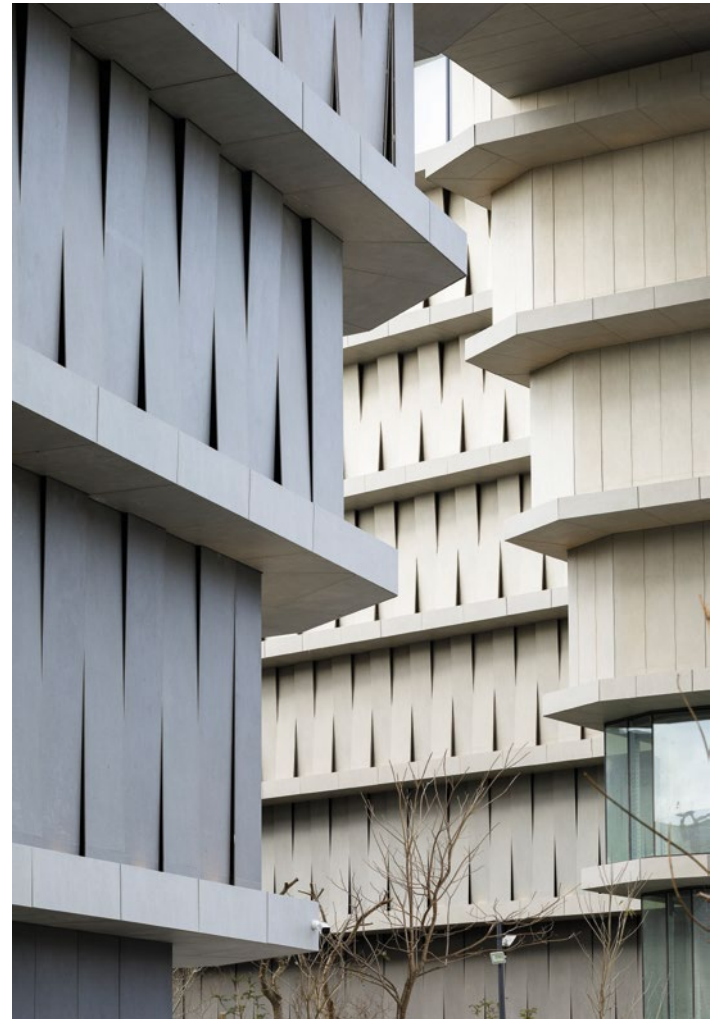

Customised colour, graded in six shades

The Toha skyscraper challenge was clear from the very beginning: to create, from a photographic reference provided by the architecture studio in charge of the project, a customised colour with a six-shade colour transition.

The collaboration between the team of architects, which received sketches and feedback during the process, and the dynamic and well-coordinated work of Cosentino's team, made it possible to overcome the challenge and achieve a perfect colour grade.



Large format design possibilities

Large-format Dekton® panels were used to give visual continuity to the building. In addition, the installation of Dekton® panels had to be done in a very specific way: angled in a criss-cross pattern, creating a ventilated façade, unique in the world.

Colour Stability

Accelerated Dekton® Ageing.

Cosentino has conducted tests on Dekton® surfaces to prove its stability to ultraviolet light. These tests have been done in an accelerated ageing xenon arc light chamber.

To do these tests two colours were selected as representative of the white and black ranges, Zenith and Domoos.

Tests have been conducted with a team model (Q Sun XE 3 HS) with daily light filters and irradiation of 0.51 W/m² in 340 nm and following a typical 102/18 cycle based on ISO 11341:2004 with the following test parameters: Dark panel temperature 63°C, air chamber temperature 43°C, humidity 30%; 1.42 hours of light/18 minutes of light and water spraying.

After 5000 hours of exposure, samples were measured and compared with a parameter that clearly determines colour variation. This is ΔE (Delta E) from CIELab. When the difference between two colours is $\Delta E < 1$ this means that both colours can be considered the same. If the colour change is $\Delta E > 1$ then it can be noticed by the human eye.

Results of this test:

Dekton® Colour	Exposure time	ΔE^*
Domoos	>5000	<1
Zenith	>5000	<1

These values show that Dekton® is not altered by UV radiation so it can be used in outdoor applications.

Customising Cuts & Special Elements

With Dekton® it is possible to customise cuts, shapes and special mounted elements.

Please contact the Project Service Unit (PSU) to find a customised solution.

Possibilities and references

Minimum formats

Thickness (cm)	Format (cm)
	71 x 71
	71 x 142
	142 x 142
0.4	79 x 143
0.8	106 x 71
1.2	106 x 143
2	159 x 71
	159 x 143
	144 x 320
	71 x 320

Pieces with unique shapes (L & U shapes)

Corners in façade openings are typically weaker points where stresses of the building structure or support wall can be easily transmitted to the cladding causing cracks to appear. This can be due to several factors such as the deviation of slabs and beams, differential settlements of foundations, expansion of the wall support etc.

For this reason, it is not recommended to cut special shaped pieces (L or U shapes) in facade application.

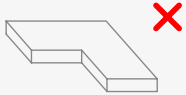

Example of L shaped piece in elevation and best layout solutions proposed:

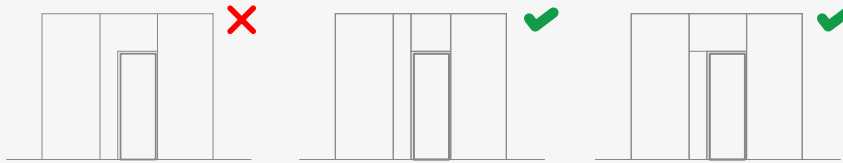

In the event that these kinds of shapes cannot be avoided, it is recommended a minimum radius of 10mm in interior corners.

Cut-outs

When cut-outs are to be done on site, the recommended process is drilling in the corners before cutting. Mortises need to have drill holes with a minimum radius of 5mm before cutting. These cannot be done too close to edges and a minimum distance of 50mm to the edge is advisable.

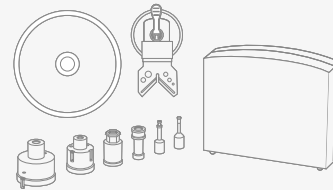

Approved disc and bit

Drilling

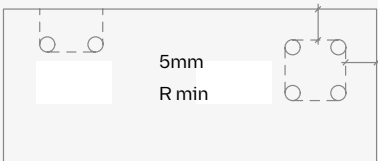

Cuts

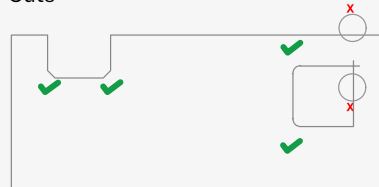

min. 50mm

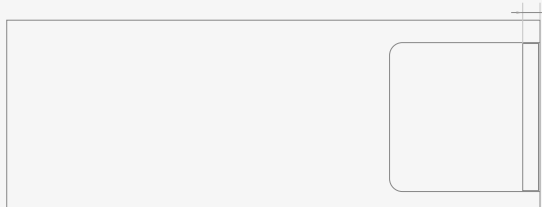

Assembled pieces (L & U mounting)

Beveled edges of integral corners and U-shapes include drill holes, reinforced profiles, and metallic elements to reinforce the joint.

For return pieces with mechanical fixing systems in ventilated façade application, it is recommended a minimum width of 70mm and a maximum of 210mm.

Dimension limitations, overhangs and distances between angular brackets and drill holes for special solutions should be studied for each case (Ask for support from the Project Service Unit - Facades technical department)

U Shape

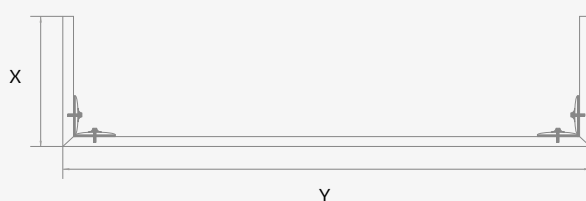

L Shape



Beveled corners joined with mechanical fixing:

- Returns width $70\text{mm} \leq X \leq 210\text{mm}$.
- Minimum open joint of 1-2 mm.

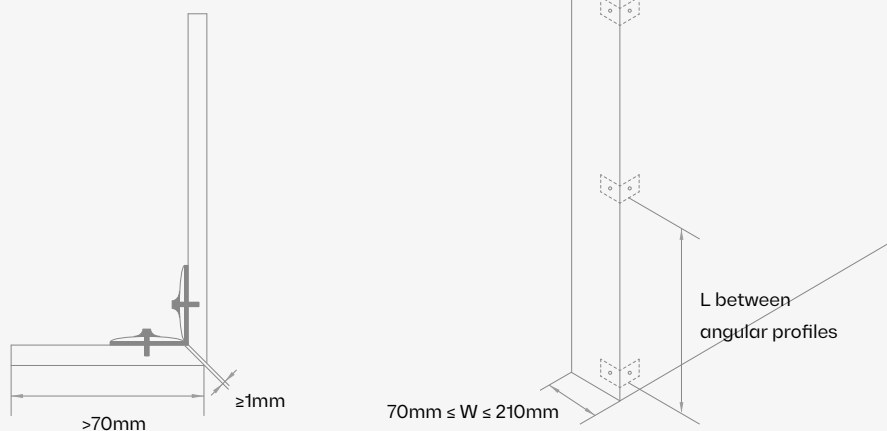

Cosentino's technical department offer specialised support to define and optimise a solution for each project.

Cladding System

03

- 58 Ventilated Facades
- 60 Subframe and Fixing Systems
- 63 Cladding System
- 66 Dekton® Corner Solutions



Ventilated Facade

The ventilated facade is a construction solution that allows for the establishment of a physical separation between the exterior cladding solution and the supporting wall of the building.

This separation creates a ventilated chamber that allows the renewal of air, which allows a series of thermal, acoustic and functional advantages that give it great added value.

Advantages

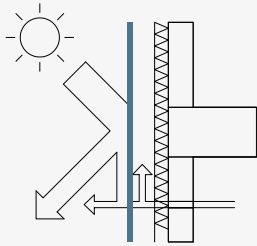

Energy savings

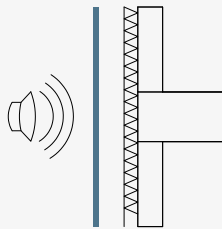

Acoustic insulation

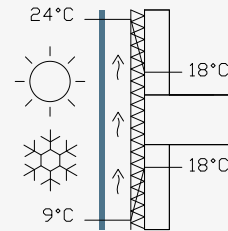

Health: prevents thermal bridges and condensation

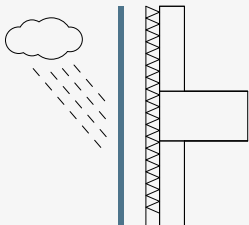

Protection against water filtrations

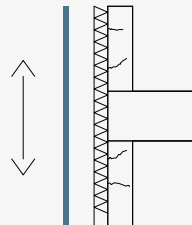

Support wall protection

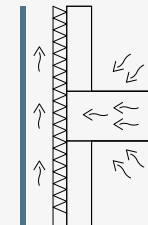

Thermal insulation

Structural requirements

In facade projects, Cosentino provides a wide range of certifications available and data sheets for static calculations required on each project.

Wind loads

The local standards must be considered in order to determine the best solution for the panel and fixing, especially in tall buildings or areas classified with high wind loads.

- Some certificates such as Miami Dade NOA guarantees the product is resistant against the most severe weather conditions and ensures material performance under high wind loads.

Fire classification

Many European countries have adopted the European Reaction to Fire classification system (Euroclasses). Testing is defined in standard UNE-EN 13501-1: Fire classification of construction products and building elements. There are seven Reaction to Fire classification levels, depending on the contribution to fire: A1, A2, B, C, D, E and F, from best (A1 and A2 are non-combustible) to worst. There are three smoke intensity levels: s1, s2 and s3. There are three classes of burning droplets: d0, d1 and d2 (Table A)

Seismic performance

In the event of an earthquake, lightweight ventilated facades perform better than heavier materials and solid wall solutions.

Lightweight substructures used in ventilated facades function by absorbing and dissipating the tensions generated due to building movements limiting the damage and making it easier to repair.

- Dekton successfully performs on tests such as Taiwanese NCREE seismic test reports.

Table A

Contribution to fire A-B-C-D-E-F	Smoke production s1, s2, s3	Flaming droplets/particles d0 - d1 - d2
A1 No contribution to fire.	No test needed	No test needed
A2 No contribution to fire.	s1 Quantity/Speed of emission low.	d0 No burning droplets
B Very limited contribution to fire.	s2 Quantity/Speed of emission average.	d1 Slow rate of burning droplets.
C Limited contribution to fire.	s3 Quantity/Speed of emission high.	d2 High degree of burning droplets.
D Acceptable contribution to fire.		
E Acceptable contribution to fire.	Not tested	-
F No performance requirements.		

The fire requirements will usually depend on the height of the building; for 18m and higher, buildings in Spain require a B-S3-d2 classification.

- Façade panels with fire classification A1 or A2-s1, d0 like Dekton are most desirable because they have the highest level of Reaction to Fire Classification and present the best performance against the spread of fire.

Subframe and Fixing Systems

Overview of fixing types

DKT1 ●

Hidden mechanical fixing using undercut screws on the reverse side of the piece.

Thickness: 8, 12 and 20 mm

Price: *****

Format: All formats.

Certificates: ETA, BBA (12 y 20 mm)

DKT2 ●

Hidden mechanical fixing with metallic profile on the continuous grooved edge of the piece.

Thickness: 12 and 20 mm

Price: ***

Format: not suitable for big formats on vertical layout.

Certificates: ETA, BBA

DKT3 ●

Hidden mechanical fixing with clips at intervals along the groove on the edge of the piece.

Thickness: 12 and 20 mm

Price: **

Format: not suitable for big formats on vertical layout.

Certificates: ETA, BBA

DKT4

Mechanical fixing using visible clips that hold the pieces.

Thickness: 4, 8, 12 and 20 mm

Price: *

Format: Not suitable for big formats on vertical layout.

DKBG ●

Mixed fixing (mechanical plus chemical) hidden in the groove on the reverse side of the piece.

Thickness: 8, 12 and 20 mm

Price: ****

Format: All formats

DKC ●

Chemical structural fixing of pieces onto profiles.

Thickness: 4, 8 and 12 mm

Price: *

Format: All formats

Certificates: ETA SIKA, KOMO Innotec, KOMO Dynamic Bond, Dow Corning Silicone.

DKB

Pieces are fixed directly to the enclosure using mainly cement based adhesives.

DKS

Fixing of pieces onto an external thermal insulation system (ETIS)

● Systems certified for ventilated facades

Indicates an approximate price level compared from the lowest price (*) to the highest price (****).

DKT1

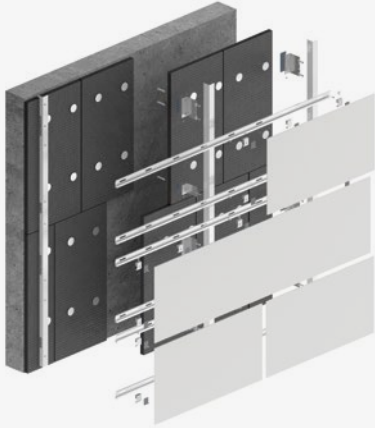

DKT2

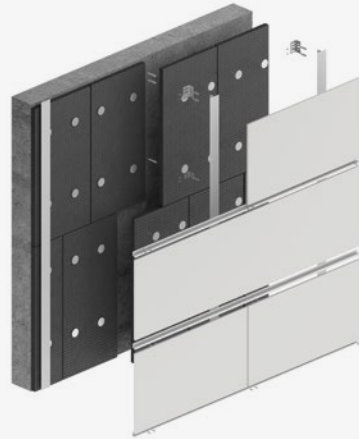

DKT3



DKT4

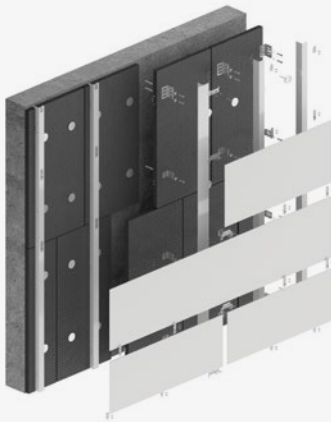

DKBG

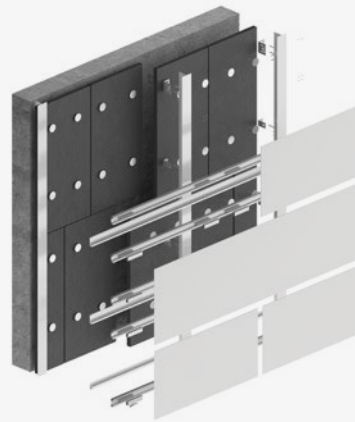

DKC

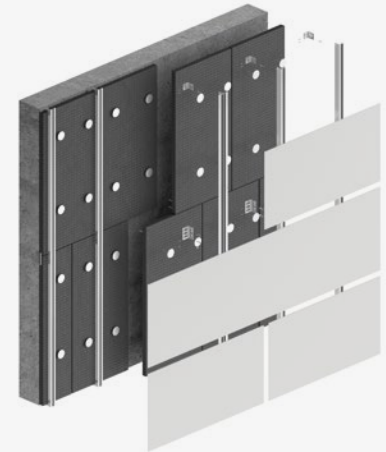

DKB

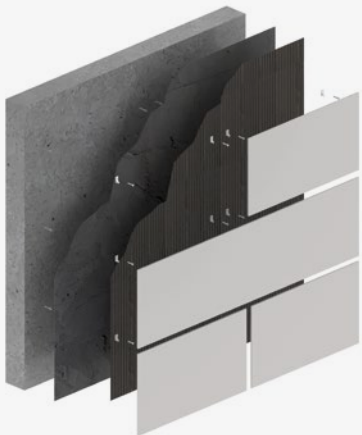

DKS

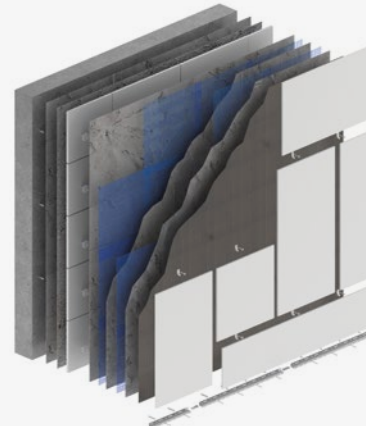

Table for different thicknesses and systems

FACADE SYSTEM	DESCRIPTION	MAX. SIZE	4mm	8mm	12mm	20mm	
DKT1.1	Undercut anchor-Keil	FULL SLAB	●	KH 4 M6/8.5 ●	KH 8.5 M6/11.5 ●		
DKT1.2	Undercut anchor-Fischer	FULL SLAB	●	FZP II 11x6 M6/T/10pa ●	FZP II 11x8 M6/T/10PA ●	FZP II 11x10 M6/T/12PA ●	
DKT2	Grooved edge and continuous profile	V: 1400 x H: 3200	●	●	Top/Bottom/Middle Profiles ●		
DKT3	Grooved edge and spot clips	V: 700 x H: 3200					
DKT4	Visible clips		System Supplier Documentation ●				
DKC	Chemical Anchor Sika	FULL SLAB	System Supplier Documentation ●				●
	Chemical Anchor Dow Corning						
	Chemical Anchor Innotec						
	Chemical Anchor Bostik						
	Chemical Anchor Soltec						
DKBG	Hybrid Sytems XL 45 SB Fijaciones		●	System Supplier Documentation ●			
	Hybrid Sytems Rediwa Cat 1 Wandegar						
DKB	Direct Adhesion		R2 (UNE 12004) ●	C2S2 (UNE 12004) ●		●	
DKS	SATE/ETICS/EIFS	V: 500 x H: 1500	●	C2S2 (UNE 12004) ●	●	●	

● ETA 14-0413 ● Possible ● Not Possible

Note: The author of the project must assess the appropriate thickness based on the planned activity and specific needs that cannot be collected in this guidance sheet. The definition and calculation of each system must be done by a competent technician according to the particular conditions of each project.

Dekton® 4mm is always supplied with mesh for all facade applications.
Dekton® 8, 12 or 20 mm is supplied with mesh for ventilated façades and without mesh for façade cladding and SATE direct adherence systems.

Cladding System

Parts of a ventilated cladding system

Supporting wall
 Brackets
 Substructure
 Insulation and waterproofing
 Fixings
 Dekton®

Supporting wall

Support material can be either structural (beams, columns, slabs, bearing walls...) or not structural (brick walls, block walls, stud walls...).

The usual engineering of a ventilated façade considers substrate walls to bear directly horizontal loads (such as wind loads), while dead loads are designed to be directly supported by structural elements.

Insulation and waterproofing

Insulation should be applied continuously over substrate walls in order to achieve the required thermal and acoustic comfort level inside the building and avoiding thermal breaks when possible - weaknesses in the insulation will be where there is the greatest loss of energy from the building.

There are many materials available on the market, to be chosen considering their different properties such as thermal insulation values, fire resistance, waterproofing, etc.

- Mineral wool
- EPS, XPS
- PUR, PIR
- Other insulation materials (cork, natural fibres...)

Air chamber

One of the main features of ventilated facades is the air chamber. It is designed to act as a pillow of pressure to prevent water from reaching the insulation or supporting wall.

By ventilating the chamber, the moisture that could arise from water that may pass through the cladding system, whether from the internal wall's surface or appearing as condensation, will be removed by evaporation or simply slide down the back of the panel and fall from the wall bracket.

◦ Chamber Width

It is generally considered that the minimum width of the chamber should be at least 20mm, behind the rear of the facade panel. However, in some countries such as GB and Scandinavian countries, the regulations indicate a minimum width of 50mm. Therefore, it is important that national regulations and building codes are adopted in each country.

This minimum width is only suitable for low buildings, up to 10m. As the facade increases in height, the chamber needs to increase in width. For example, in Belgium and the Netherlands the following chamber width is recommended:

Building Height (m)	0-10	10-20	20-50
Min. cavity width (mm)	20	25	30

The type of joint used between the panels will also influence the width of the chamber. Open horizontal joints will allow more air movement than closed joints and therefore wider cavities should be considered when using closed profiles in horizontal joints.

◦ Protection of insulation in the chamber

Just as the chambers are ventilated through the upper and lower part of the façade (it is considered that this ventilation is achieved with a cross section of at least 50 cm² for each linear metre), it is also important to allow the air to enter and exit below and above openings like windows.

These openings need to be protected so that birds and small animals cannot enter the chamber. In the absence or failure of protection this could result in damage to the insulation, air chamber, or even on the supporting wall. This protection is usually achieved by fitting a perforated profile. It is important that the perforations are the correct size to allow a flow of air, while keeping creatures out.

Ventilated facade substructure

General indications for the main structure

1. Based on the cutting of the facade and the arrangement of the system's profiling, define the anchor points of the brackets in the support elements.
 2. Verify the correct level of flatness, deviations and plumb of the substrate wall and correct if necessary, according to the project tolerances.
 3. Anchor the supporting brackets to load bearing areas of the building (e.g. Slab edges) and use the vertical profiles to align the retaining brackets.
- Fixed point supporting brackets carry the vertical weight of the profiles and cladding, as well as support horizontal wind loads (pressure and suction). This kind of bracket is usually longer than retaining brackets and present several drill holes for fixed points to the vertical profile.
- Retaining brackets with sliding point fixing only support horizontal loads (wind loads).
- Each vertical profile usually has a single fixed point of attachment to a support bracket, and the rest of the joints are sliding points to allow expansion of the vertical profiles.
4. Place the necessary brackets according to the load bearing capacity of the support wall and the structural calculation made. To do this, the type of anchorage (mechanical or chemical) must be defined according to the support wall properties, carrying out on-site dowel extension and load tests if necessary, in order to define the load bearing capacity of the supporting wall.
 5. Insert the vertical profiles into the brackets, adjust and level so the profiles are not subject to stress before screwing the profiles to them.
 6. Use the round holes for screwing vertical profiles to brackets with fix points, and vertical slot holes for sliding points.
 7. Leave a gap between the end of one profile and the beginning of the other, typically 20mm or at least 10mm, according to length and expansion of vertical profiles. Facade cladding should never extend over a joint between profiles.
 8. The supplier of the substructure should define the cantilever of the profiles depending on static calculations made and system chosen.
 9. It is recommended that the air chamber between cladding and insulation is wide enough to avoid interference between the subframe and inner layers of the wall (insulation and waterproofing).
 10. For panel installation, refer to each type of panel fixing system.
- In case of fixing onto a stud wall, brackets should be fixed onto the studs.
- The length of the brackets can be adapted to achieve the desired distance between exterior panels and the support wall.

General recommendations for Dekton® on ventilated facades

1. The minimum width recommended for pieces in ventilated facades is 200mm;
2. Proportion (width: length) of 1:14 is recommended in order to ease manufacture and manipulation of pieces.
3. Custom cutting tolerances and machining of cut and machined pieces in our factory can be discussed with our Technical Department.

DKT1

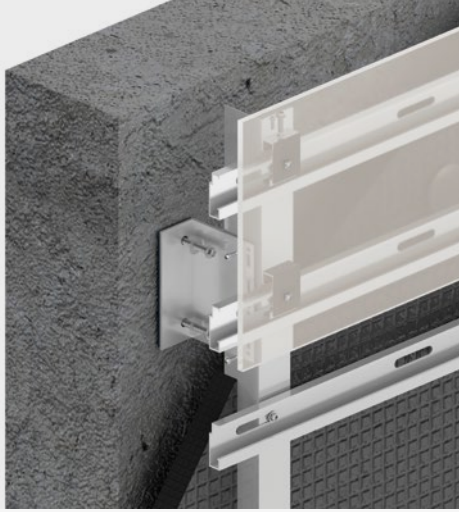

DKT2

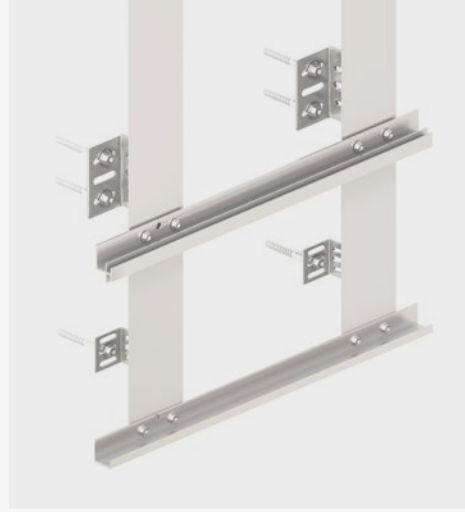

DKT3



DKT4



DKBG



DKC



Dekton® Corner Solutions

Open Exterior Corner

Open exterior corner



Open exterior corner with hidden profile.



Open exterior corner with visible profile

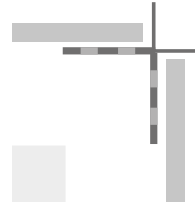

Corner with overlap

Exterior corner with overlap.



Exterior corner with overlap and hidden profile



Bevelled corner

Exterior bevelled corner

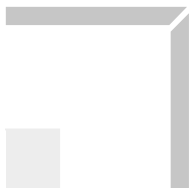

Exterior bevelled corner with hidden profile

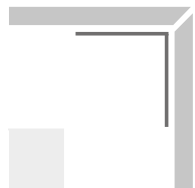

Exterior integrated bevelled corner

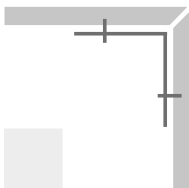

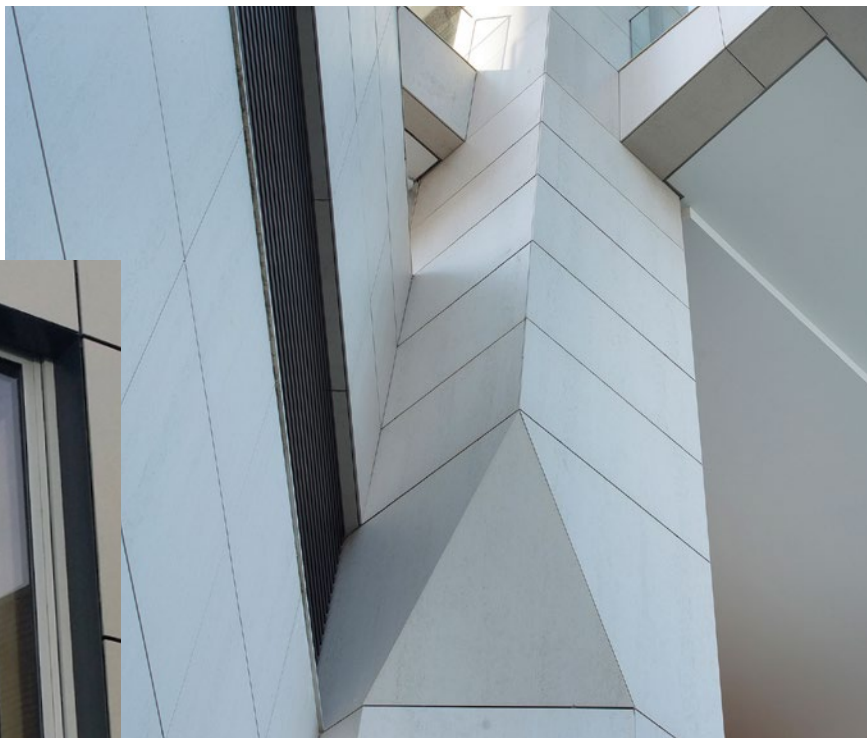

Cap Ferrat Building, Rio de Janeiro, Brazil



My Fathers Heart, Sheffield (UK.)



Shittethelm Office Building (Germany)



Erlangen Hospital (Germany)





Joints between panels in ventilated facade systems

Cladding and subframe should apply joints where building expansion, compression and structural joints are designed, as well as between panels.

- Structural joints must be placed in the same position as the ones of the building.
- Compression joints are made horizontally at each level, with a recommended gap of 15mm. They are commonly used in North America.
- Expansion joints are made vertically, each 6m, and at 5m from the corner of the building, recommended with 10mm thickness.
- Vertical and horizontal joints between panels are recommended to have a minimum of 6mm (butt end joints are not recommended due to possible tension between panels) and up to 10mm, while 6-8 mm is the most common joint width with minimal penetration of water. The dimensions of the joints between panels should be made considering the size, expansion and shrinkage of the panels and substructure.

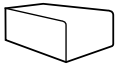
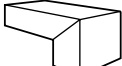
Edges

The following table shows the recommended edge finish depending on the possible impact on the pieces.

Features	Straight edge (2mm min. bevel, recommended 3>mm bevel)	Mitred edge (2mm min. bevel, recommended 3>mm bevel)	Rounded edge	Knife edge	Half Bullnose	Bullnose
Ease of fabrication	 High	 Medium	 Medium-high	 Low	 Low	 Low
Top Impact	****	****	***	**	**	*
Side Impact	****	****	****	**	***	*

Types of Fixing

04

74	DKT1
108	DKT2
126	DKT3
142	DKT4
154	DKBG
180	DKC
196	DKB
206	DKS



Subframe and Fixing Systems

Index of fixing system

DK T1

DKT1
Hidden mechanical fixing using undercut screws on the reverse side of the piece.

Page 74

DK T2

DKT2
Hidden mechanical fixing with metallic profile on the continuous groove on the edge of the piece.

Page 108

DK T3

DKT3
Hidden mechanical fixing with clips at intervals along the groove on the edge of the piece.

Page 126

DK T4

DKT4
Mechanical fixing using visible clips to hold the pieces.

Page 142

DK BG

DKBG
Mixed fixing (mechanical plus chemical) hidden in the groove on the reverse side of the piece

Page 154

DK C

DKC
Chemical structural fixing of pieces onto profiles.

Page 180

DK B

DKB
Pieces are fixed directly to supporting wall using mainly cement based adhesives.

Page 196

DK S

DKS
Fixing of pieces onto an external thermal insulation system (ETIS)

Page 206



DK T1

Undercut Anchor System

The panels are fixed to the wall by attaching the metal hangers on the horizontal profiles.

Each plate has two adjustment points and a fixed point at the top, which makes possible the adjustment while preventing undesired movements of the piece.

DKT1 system lends lots of design freedom and a wide range of combinations, allowing modification of panel sizes both horizontally and vertically.

Projects with impossible layouts.

There are very complex facades with different formats in the same design. A flexible system is needed to optimise the points of fixing the material to the substructure and that responds to the principal loads of each project. The screws are anchored to the profile, ensuring the fixing of the entire piece to the substructure.

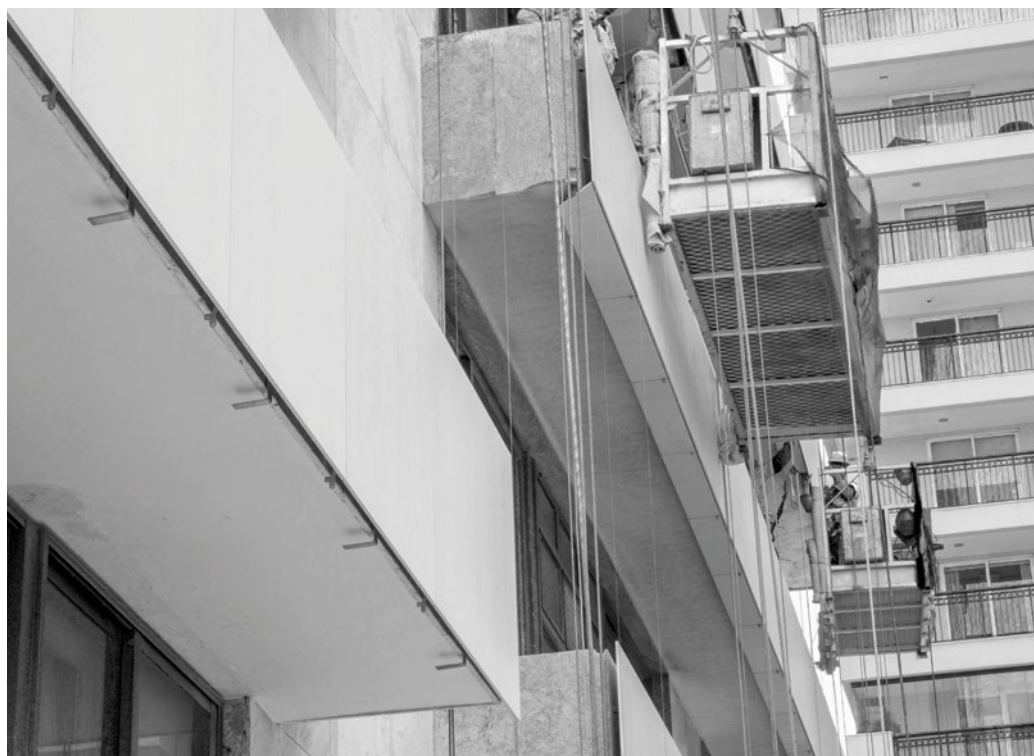

Dekton® has the certifications for ventilated façades according to ETA 14/0413 and BBA 16/5346 in thicknesses 12mm and 20mm, although it can be used in other non-certified thicknesses.

In the DKT1 system, individual stresses that Dekton material and anchors must absorb are calculated depending on the density of fasteners and minimum distances between drill holes.

The cylindrical drilling, as well as the undercut drilling, achieve a clean and precise hole, where the plug and the frusto-conical screw work together under traction on the reverse of the material.

Concealed fixing system by using metal hangers attached to the panel via undercut anchors to the back of the pieces.



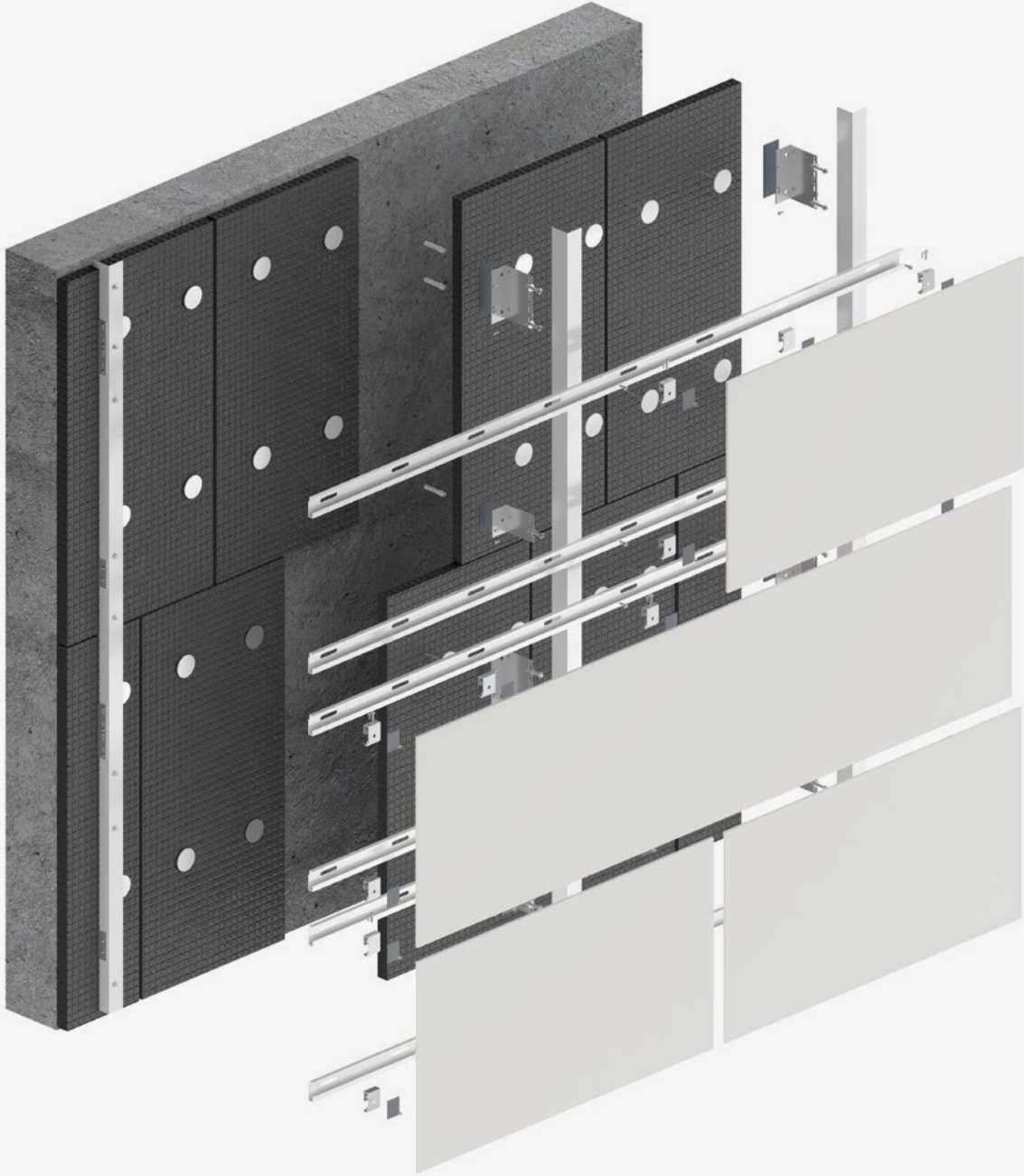

DKT1 - Diagram

Adjustable hanger



Back view

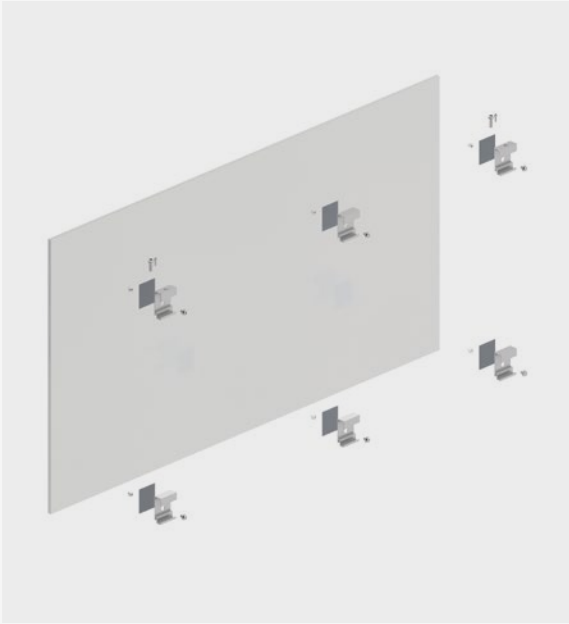

Fixed hanger

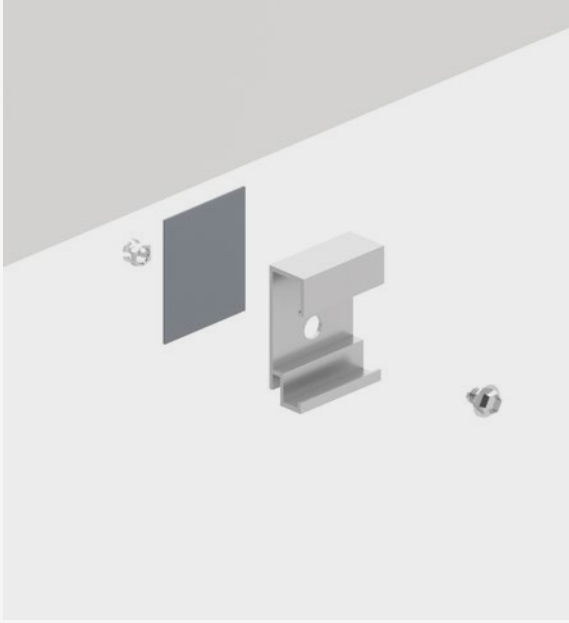

Joints



Secondary structure and general assembly instructions

1. Arrange the horizontal profiles by levelling and marking their position on the vertical structure previously installed.
2. Fix the horizontal profiles to the vertical ones in horizontal slots with self tapping screws.

To control the expansion direction of the horizontal profile, use one fixed point in each profile and sliding points for the rest of the fixings.

3. Insert the undercut anchors into the rear panel drill holes.

Minimum recommended distribution is 4 anchors per panel.

Minimum recommended distance to perimeter is between 5-20 cm.

4. Pre-assemble the hanging clips to the rear panel face by fixing them into the undercut anchors. Attach the adjustable hangers at the top level on the corners, and the rest of the hangers to the rest of the anchors with the corresponding screws and bolts.

5. Hang the piece with the assembled hangers by hooking and positioning them into the horizontal profiles.

When installing the panels, it is recommended to always follow the same direction from bottom to top, for an easier hanging and levelling process.

6. Adjust the final position and the joints width with levelling screws on the upper corner adjustable hangers,

and fix one of them to the horizontal carrier profile with a blocking screw to control the direction of expansion without creating tension (one fixed point per piece) and to avoid slab movements.

Dead load of the panel is considered to be supported by these two upper anchors.

7. The rest of the hangers are for retention of horizontal loads due to action of the wind. Repeat the process for all the facade pieces.

This system allows an easy replacement of the pieces by unhanging the piece to be replaced and hanging on the new piece with an appropriate joint.

Fig. 1

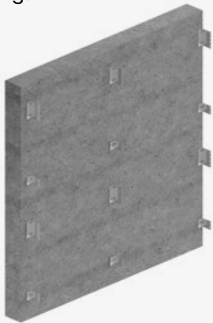

Fig. 2

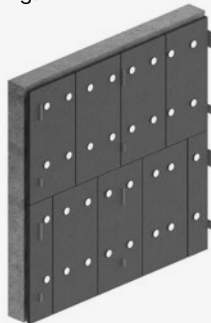

Fig. 3

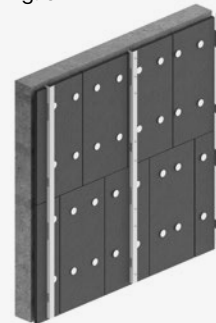

Fig. 4



Fig. 5



Fig. 6



DKT1 System Description

Hidden system

Supporting substructure composed of; metal brackets, adjustable for correction of unevenness compatible with different types of supports and can include thermal break insulation; vertical metal profiles of different sections according to the required application; horizontal metal profiles type C-Carrier/Rail; hidden anchorage system by means of undercut screw and fixing by means of Hanger/Clip accessory to the Dekton® Panel.

Installation process

Brackets installed on the surface to be covered by means of a mechanical system or welding; vertical profiles installed on brackets with a regulation and fixing system, by means of specific screws*; horizontal C-Carrier/Rail profiles with a regulation and fixing system, installed by means of specific screws* on vertical profiles; Hanger/Clip accessory after joining with hidden anchorage to the back of the Dekton® surface, installed on C-Carrier/Rail with a system of regulation and fixing.

*Specific screws according to the structural calculation of each project or indicated by the supplier of the substructure.

- Fixings: Undercut anchors and hangers on horizontal profiles.
- Depth of undercut drill and anchor: to be defined according to the thickness of Dekton and static calculation.

Recommended undercut anchors

Keil

8mm, Keil Anchor 4mm
12mm, Keil Anchor 8.5mm
20mm, Keil Anchor 8.5mm

Fischer

8mm, FZP II 11x6 M6/T/10 PA
12mm, FZP II 11x8 M6/T/12 PA
20mm, FZP II 11x10 M6/T/9 PA

Other anchors

Please contact the Technical Department

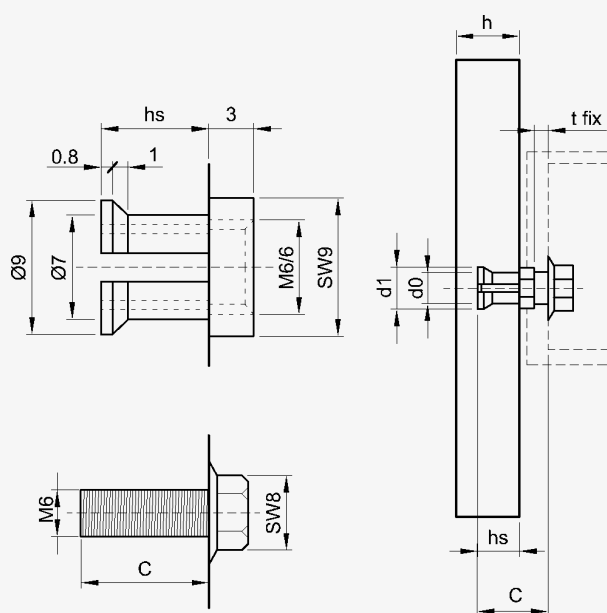

KEIL KH undercut anchor.
Anchor sleeve and hexagonal screw (DKT1.1)

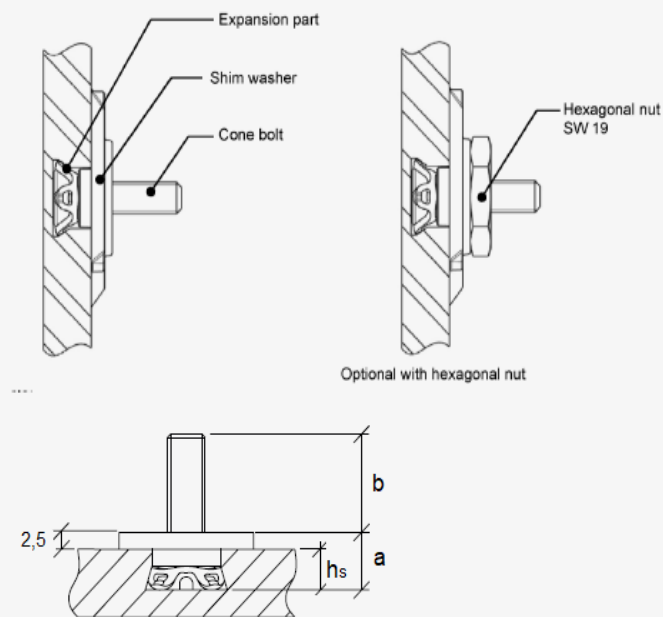

FISCHER FZP II
Undercut anchor (DKT1.2)

DKT1.1 KEIL. Horizontal section

Dekton jamb

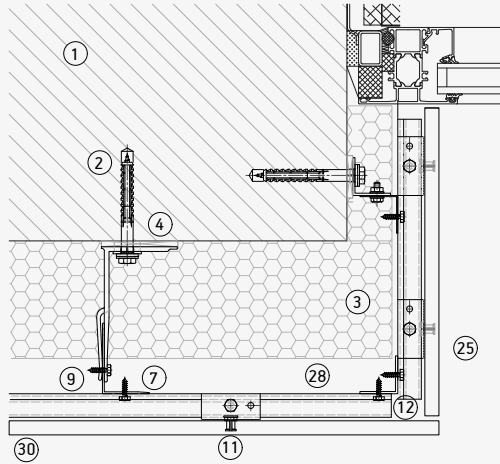

Metallic jamb

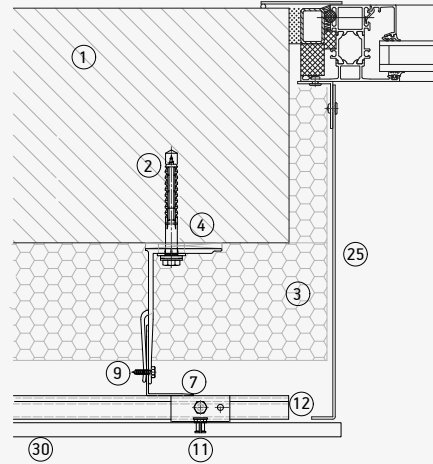

Vertical joint

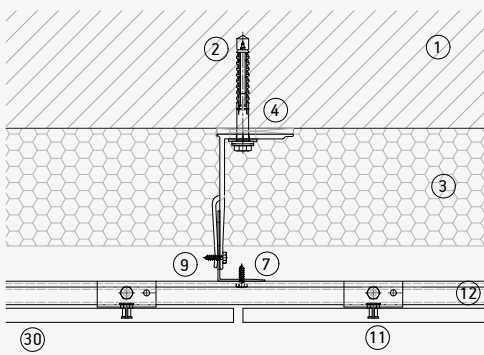

Vertical expansion joint

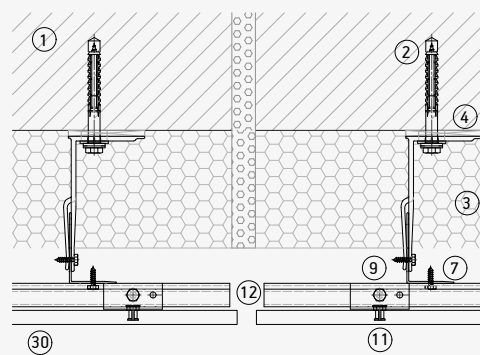

- 1. Supporting wall.
- 2. Anchor bracket.
- 3. Insulation.
- 4. Insulating layer.
- 5. Fixed bracket.
- 6. Adjustable bracket.
- 7. L profile.
- 8. T profile.
- 9. Self tapping screw.

- 10. Rivet.
- 11. Undercut anchor.
- 12. Horizontal rail.
- 13. C hanger.
- 14. Adjustable C hanger.
- 15. Bottom/top edge profile/clip.
- 16. Intermediate edge profile/clip.

- 17. Bottom/top visible clamp.
- 18. Intermediate visible clamp.
- 19. Interior back clamp
- 20. Exterior back profile
- 21. Chemical fixing system
- 22. Security fixing
- 23. Ventilation profile

- 24. Lintel
- 25. Jamb
- 26. Window sill
- 27. Top coping
- 28. Corner profile
- 29. Bonding adhesive
- 30. Dekton

DKT1.1 KEIL. Vertical section

Upper detail

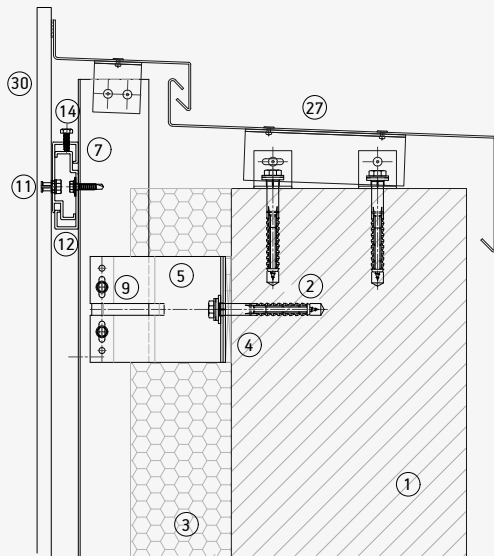

Horizontal joint

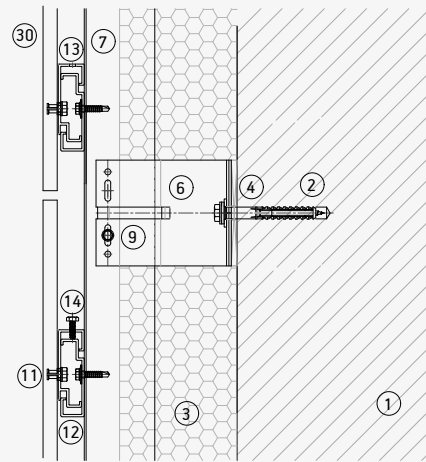

Bottom detail

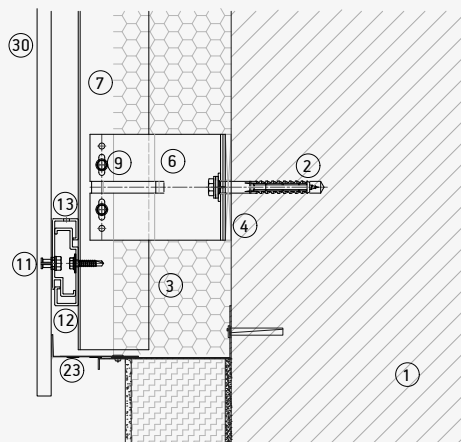

Joint between profiles

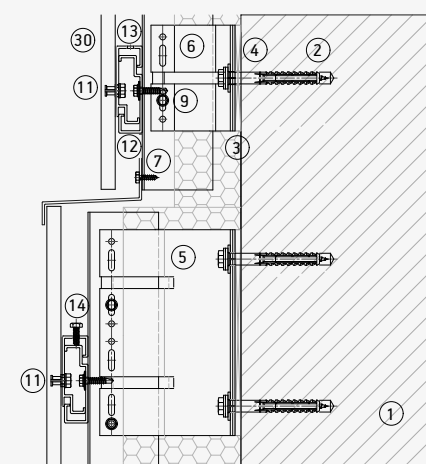

- | | | | |
|------------------------|-------------------------------------|---------------------------------|----------------------|
| 1. Supporting wall. | 10. Rivet. | 17. Bottom/top visible clamp. | 24. Lintel |
| 2. Anchor bracket. | 11. Undercut anchor. | 18. Intermediate visible clamp. | 25. Jamb |
| 3. Insulation. | 12. Horizontal rail. | 19. Interior back clamp | 26. Window sill |
| 4. Insulating layer. | 13. C hanger. | 20. Exterior back profile | 27. Top coping |
| 5. Fixed bracket. | 14. Adjustable C hanger. | 21. Chemical fixing system | 28. Corner profile |
| 6. Adjustable bracket. | 15. Bottom/top edge profile/clip. | 22. Security fixing | 29. Bonding adhesive |
| 7. L profile. | 16. Intermediate edge profile/clip. | 23. Ventilation profile | 30. Dekton |
| 8. T profile. | | | |
| 9. Self tapping screw. | | | |

DKT1.2 FISCHER. Horizontal section

Mitered external corner

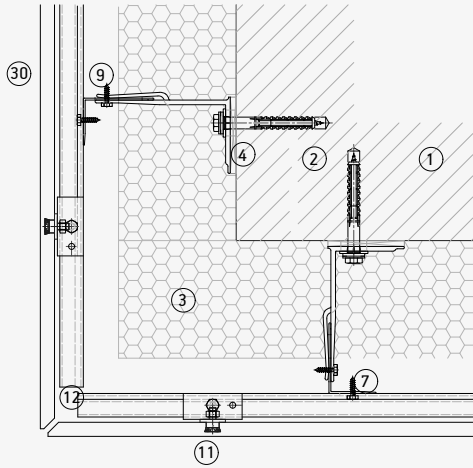

Internal Corner

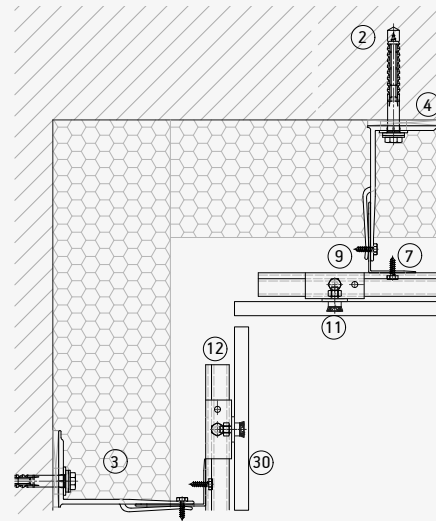

Vertical joint

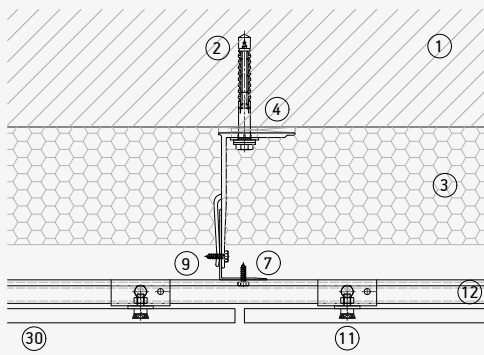

Vertical expansion joint

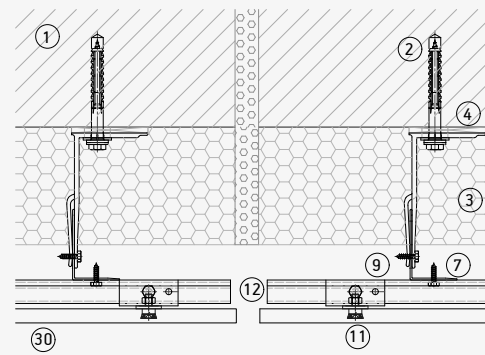

- 1. Supporting wall.
- 2. Anchor bracket.
- 3. Insulation.
- 4. Insulating layer.
- 5. Fixed bracket.
- 6. Adjustable bracket.
- 7. L profile.
- 8. T profile.
- 9. Self tapping screw.

- 10. Rivet.
- 11. Undercut anchor.
- 12. Horizontal rail.
- 13. C hanger.
- 14. Adjustable C hanger.
- 15. Bottom/top edge profile/clip.
- 16. Intermediate edge profile/clip.

- 17. Bottom/top visible clamp.
- 18. Intermediate visible clamp.
- 19. Interior back clamp
- 20. Exterior back profile
- 21. Chemical fixing system
- 22. Security fixing
- 23. Ventilation profile

- 24. Lintel
- 25. Jamb
- 26. Window sill
- 27. Top coping
- 28. Corner profile
- 29. Bonding adhesive
- 30. Dekton

DKT1.2 FISCHER. Vertical section

Upper detail

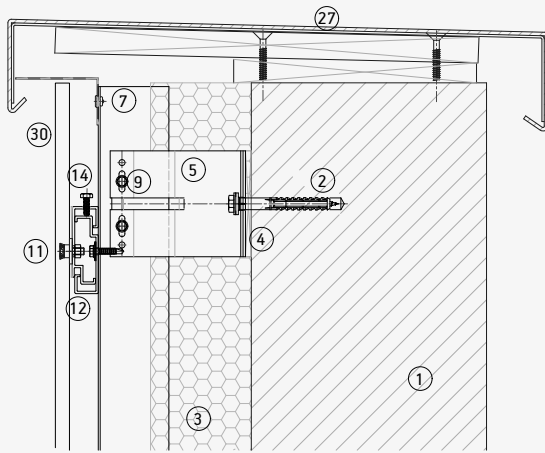

Bottom detail

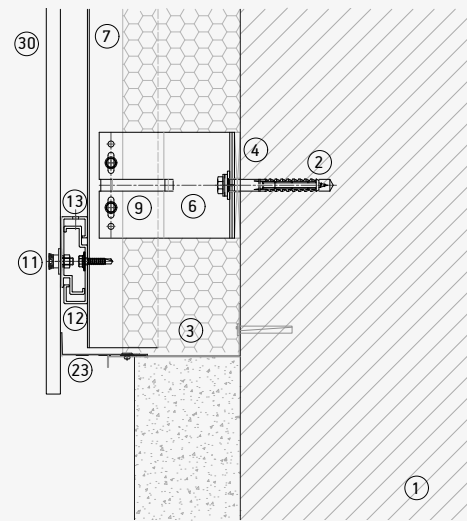

Horizontal joint

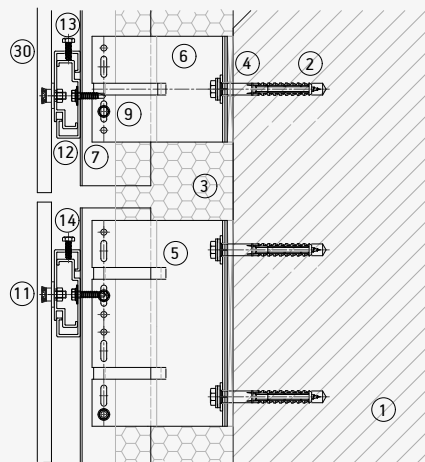

Joint option between profiles

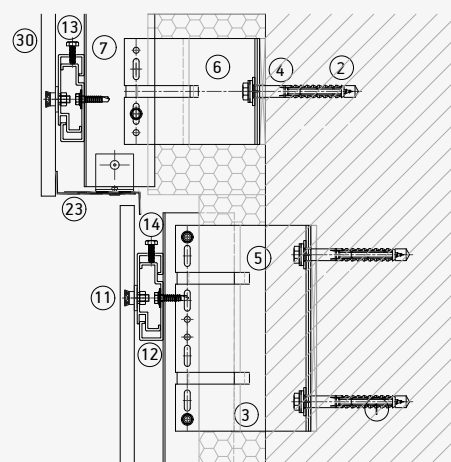

- | | | | |
|------------------------|-------------------------------------|---------------------------------|----------------------|
| 1. Supporting wall. | 10. Rivet. | 17. Bottom/top visible clamp. | 24. Lintel |
| 2. Anchor bracket. | 11. Undercut anchor. | 18. Intermediate visible clamp. | 25. Jamb |
| 3. Insulation. | 12. Horizontal rail. | 19. Interior back clamp | 26. Window sill |
| 4. Insulating layer. | 13. C hanger. | 20. Exterior back profile | 27. Top coping |
| 5. Fixed bracket. | 14. Adjustable C hanger. | 21. Chemical fixing system | 28. Corner profile |
| 6. Adjustable bracket. | 15. Bottom/top edge profile/clip. | 22. Security fixing | 29. Bonding adhesive |
| 7. L profile. | 16. Intermediate edge profile/clip. | 23. Ventilation profile | 30. Dekton |
| 8. T profile. | | | |
| 9. Self tapping screw. | | | |

DKT1 System

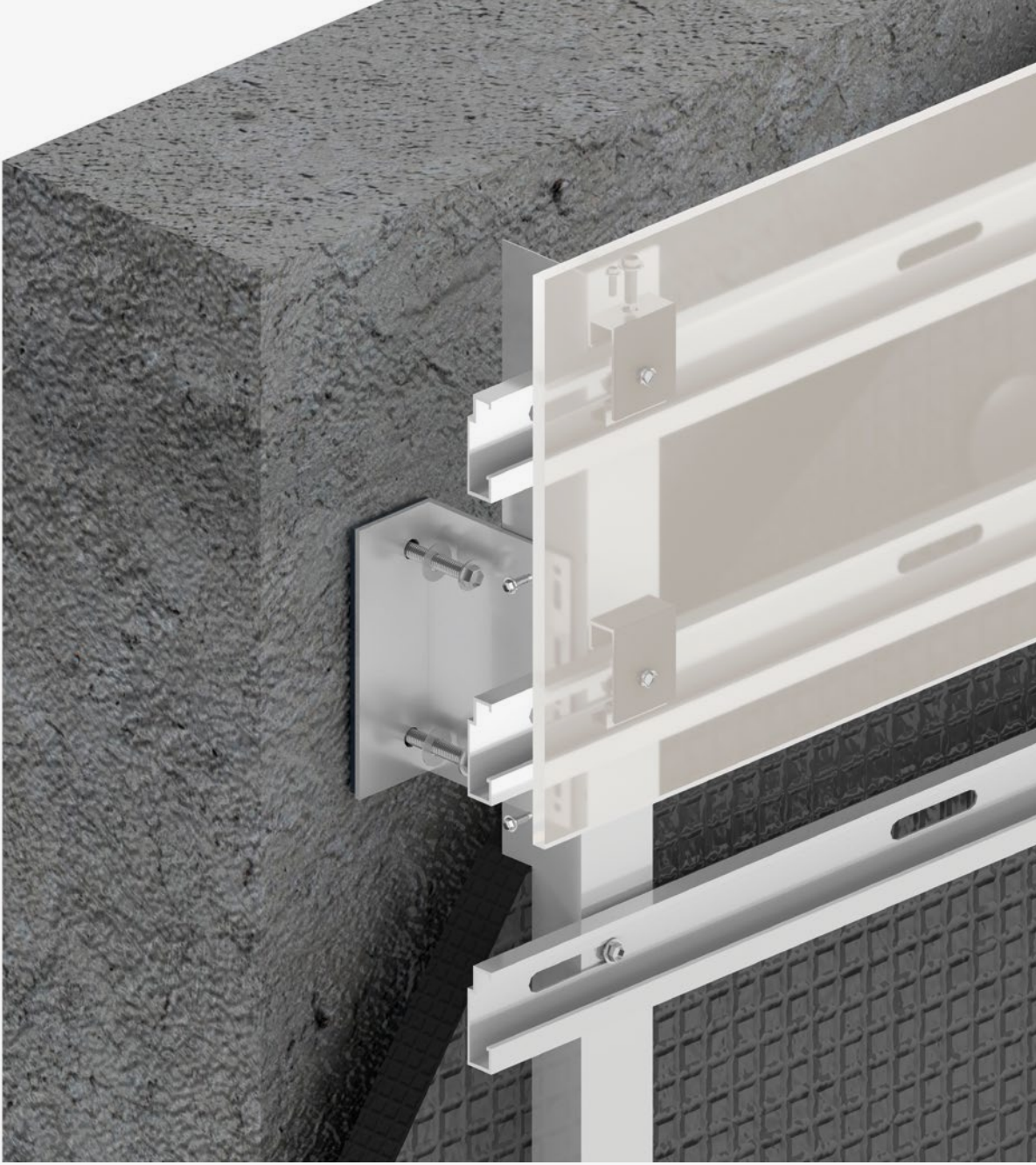

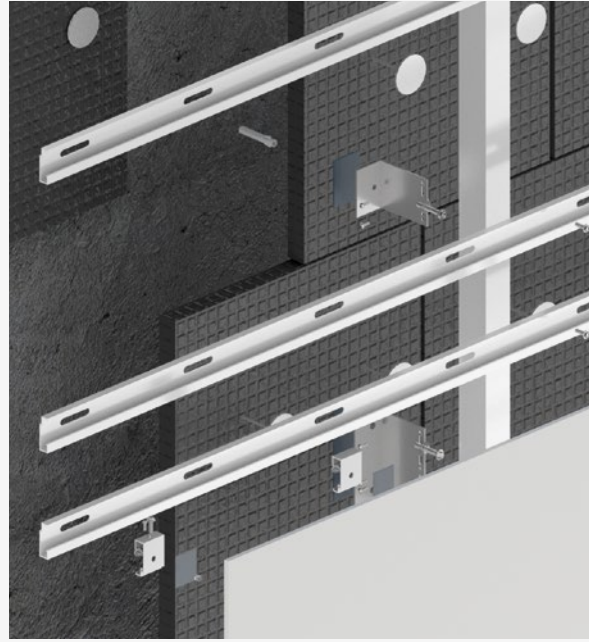
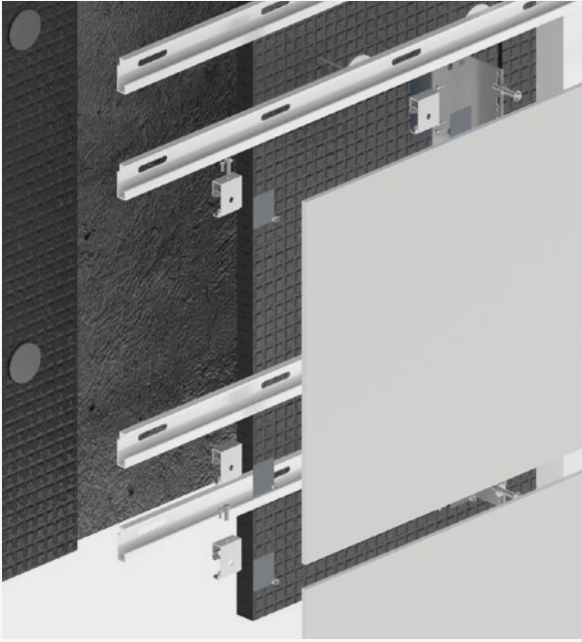
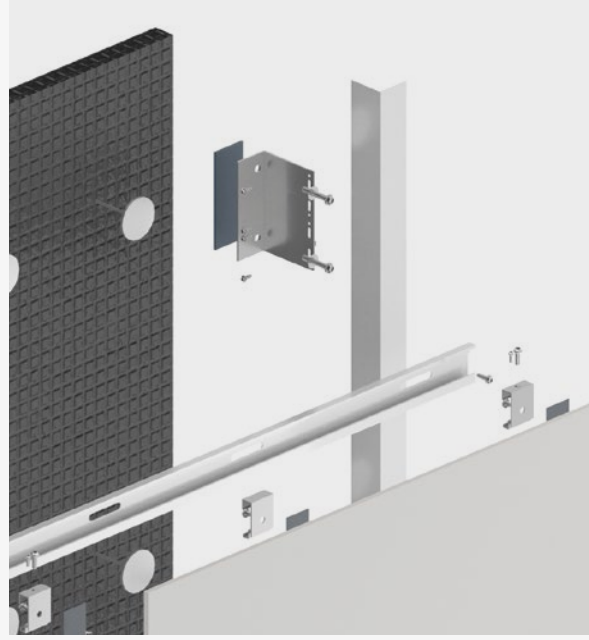
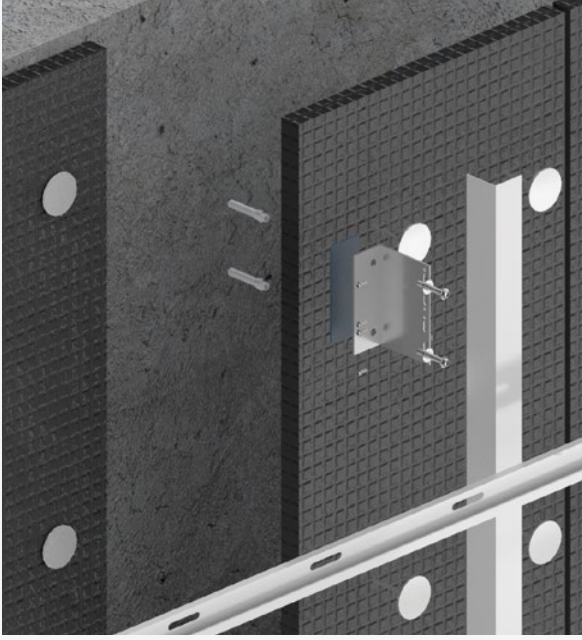

DKT1 Static Calculations

Schemes and data to be defined with SDP software

Panels in horizontal or vertical layout. Maximum wind loads shown in the following configurations depend on the grid spacing and distance from drill holes to the edges.

These configurations have been calculated considering a distance of fixing to the edges of 200mm. For other distances and configurations please contact our Technical Department.

The tables and diagrams presented are based on Dekton calculation software and refer only to Dekton®. They cannot be considered as definitive data for on-site installation and it is necessary for a qualified technician

to make a specific project calculation for the entire façade system including support anchors, brackets, profiles, screws and Dekton® fixing elements to the façade.

How to use the reference configurations:

- Determine the design wind load KN/m².
- Choose the table according to the fixing system and Dekton thickness.
- Select the closest design wind load. The wind load chosen should not be less than actual requirements.
- Select a reference configuration showing maximum spacing between fixings.

DKT1.1 KEIL

Dekton 8mm - Keil 4mm depth

Full slab configuration

Design wind load kN/m ²	Horizontal	Grid spacing (mm)	Vertical	Grid spacing (mm)
0.5	H1	H 933 x V 1040	V1	H 1040 x V 933
1	H2	H 700 x V 520	V2	H 520 x V 700
1	H3	H 560 x V 520	V3	H 520 x V 560
2	H4	H 467 x V 347	V4	H 347 x V 467

Dekton 12mm - Keil 8.5mm depth

Full slab configuration

Design wind load kN/m ²	Horizontal	Grid spacing (mm)	Vertical	Grid spacing (mm)
1.5	H1	H 933 x V 1040	V1	H 1040 x V 933
3	H2	H 700 x V 520	V2	H 520 x V 700
3.5	H3	H 560 x V 520	V3	H 520 x V 560
5.5	H4	H 467 x V 347	V4	H 347 x V 467

DKT1.2 FISCHER

Dekton 12mm - Fisher FZP II 8mm depth

Full slab configuration

Design wind load kN/m ²	Horizontal	Grid spacing (mm)	Vertical	Grid spacing (mm)
1.5	H1	H 933 x V 1040	V1	H 1040 x V 933
3	H2	H 700 x V 520	V2	H 520 x V 700
3.5	H3	H 560 x V 520	V3	H 520 x V 560
5.5	H4	H 467 x V 347	V4	H 347 x V 467

DKT1.1 KEIL. Design

The design wind loads that are compared to the reference design wind loads provided in this document must have factors on the wind load applied to the characteristic values according to the applicable standards and regulations.

Design wind loads and fixing distances should be calculated per local standards, regulations and certificates applicable, with further testing if required.

Cosentino does not provide static calculations for projects.

Cosentino will not accept any liability whatsoever for any direct or indirect damage resulting from any errors, omissions or miscalculations of the static calculations for the project.

8mm - KEIL 4mm Depth HORIZONTAL CONFIGURATION

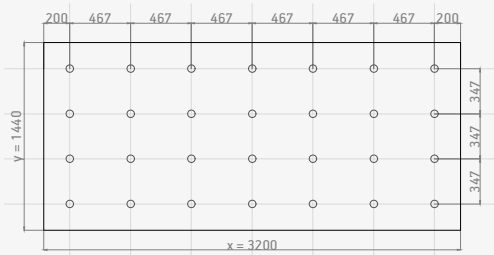

H4. Max. Design wind load: 2 kN/m²

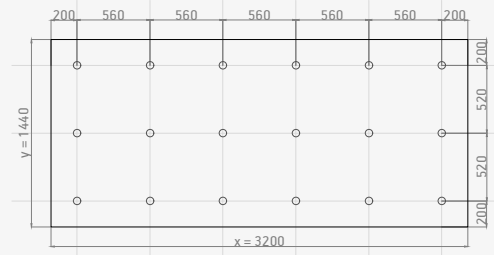

H3. Max. Design wind load: 1 kN/m²

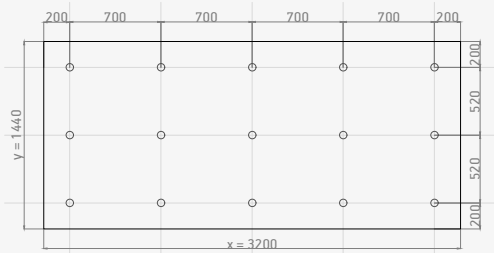

Max. Design wind load: 1 kN/m²

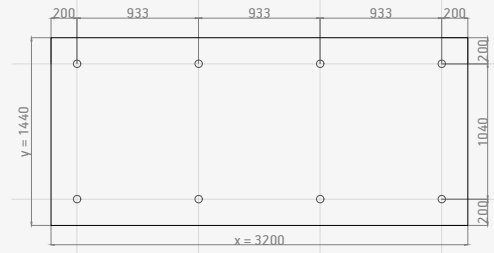

H1. Max. Design wind load: 0.5 kN/m²

VERTICAL CONFIGURATION

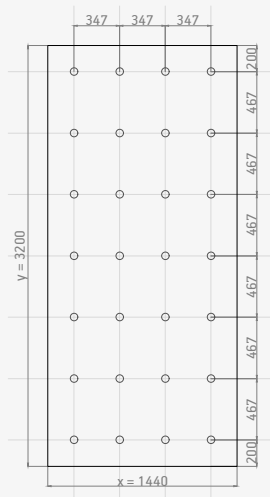

V4. Max. Design wind load: 2 kN/m²

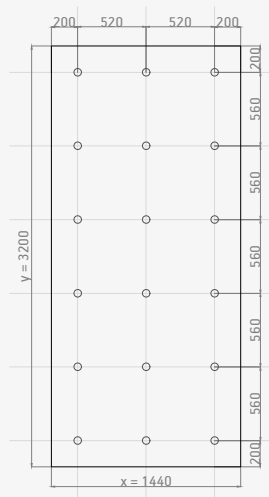

V3. Max. Design wind load: 1 kN/m²

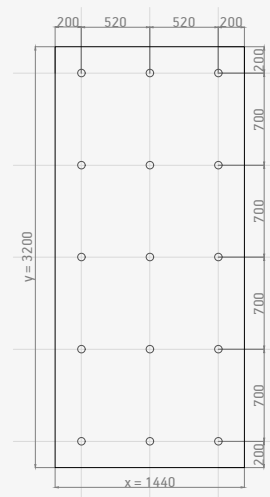

V2. Max. Design wind load: 1 kN/m²

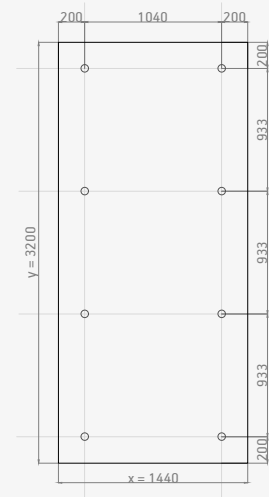

V1. Max. Design wind load: 0.5 kN/m²

DKT1.1 KEIL. Design

The design wind loads that are compared to the reference design wind loads provided in this document must have factors on the wind load applied to the characteristic values according to the applicable standards and regulations.

Design wind loads and fixing distances should be calculated per local standards, regulations and certificates applicable, with further testing if required.

Cosentino does not provide static calculations for projects.

Cosentino will not accept any liability whatsoever for any direct or indirect damage resulting from any errors, omissions or miscalculations of the static calculations for the project.

12mm - KEIL 8.5mm Depth HORIZONTAL CONFIGURATION

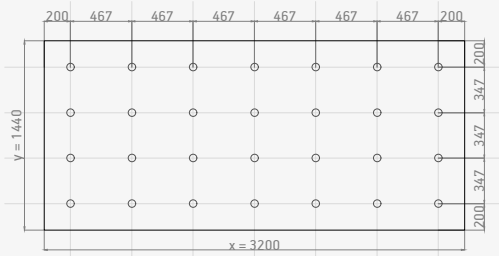

H4. Max. Design wind load: 5.5 kN/m²

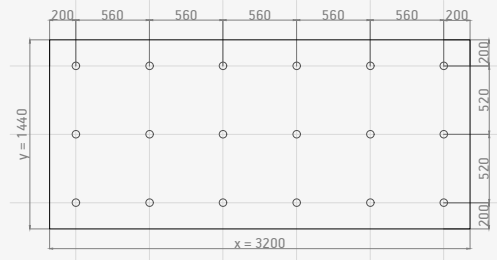

H3. Max. Design wind load: 3.5 kN/m²

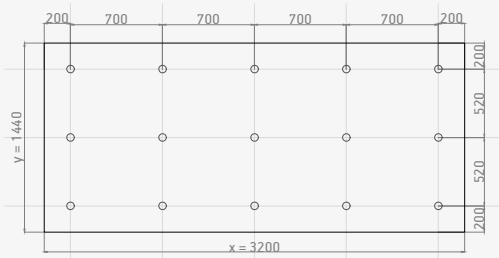

H2. Max. Design wind load: 3.0 kN/m²

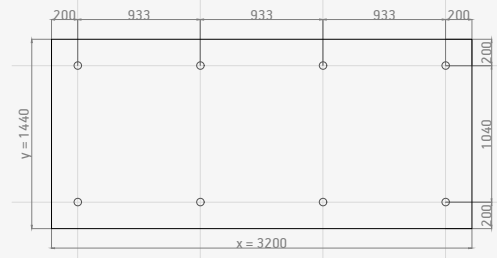

H1. Max. Design wind load: 1.5 kN/m²

VERTICAL CONFIGURATION

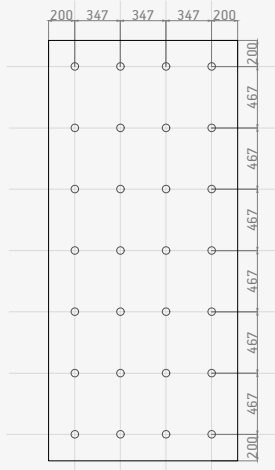

V4. Max. Design wind load: 5.5 kN/m²

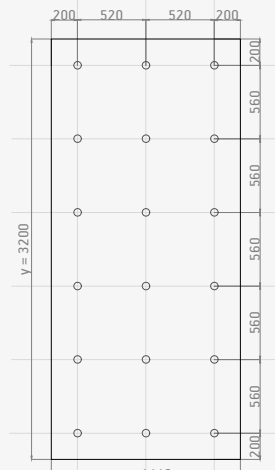

V3. Max. Design wind load: 3.5 kN/m²

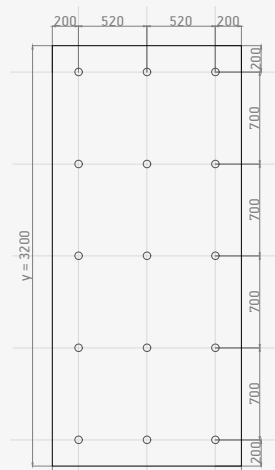

V2. Max. Design wind load: 3.0 kN/m²

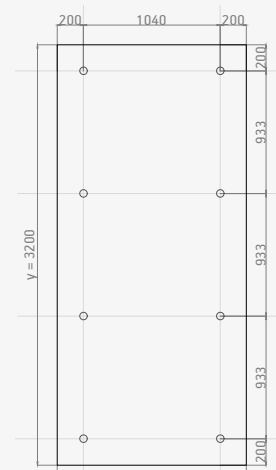

V1. Max. Design wind load: 1.5 kN/m²

DKT1.2 FISCHER. Design

The design wind loads that are compared to the reference design wind loads provided in this document must have factors on the wind load applied to the characteristic values according to the applicable standards and regulations.

Design wind loads and fixing distances should be calculated per local standards, regulations and certificates applicable, with further testing if required.

Cosentino does not provide static calculations for projects.

Cosentino will not accept any liability whatsoever for any direct or indirect damage resulting from any errors, omissions or miscalculations of the static calculations for the project.

12mm - FISCHER 8mm Depth HORIZONTAL CONFIGURATION

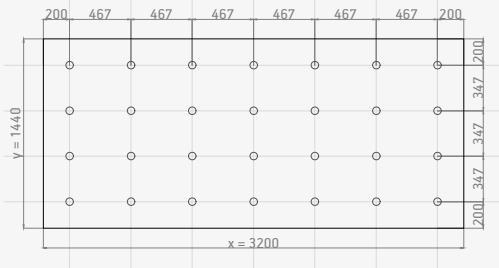

H4. Max. Design wind load: 5.5 kN/m²

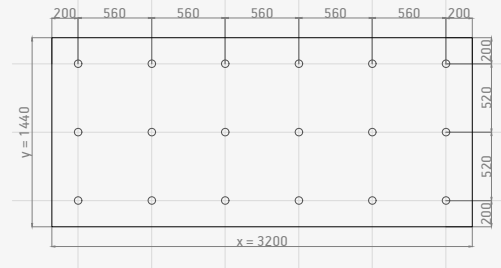

H3. Max. Design wind load: 3.5 kN/m²

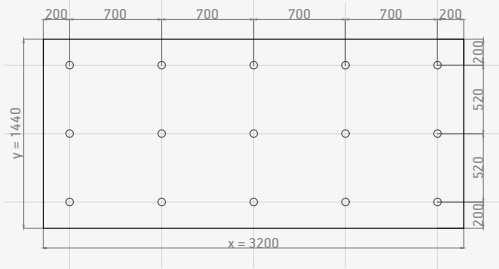

H2. Max. Design wind load: 3.0 kN/m²

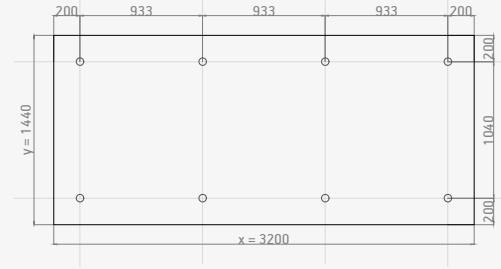

H1. Max. Design wind load: 1.5 kN/m²

VERTICAL CONFIGURATION

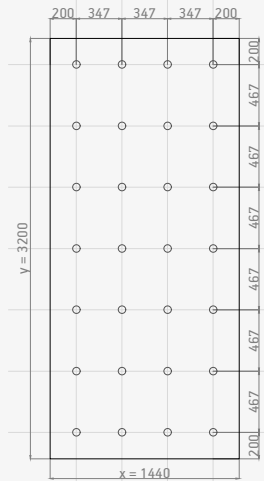

V4. Max. Design wind load: 5.5 kN/m²

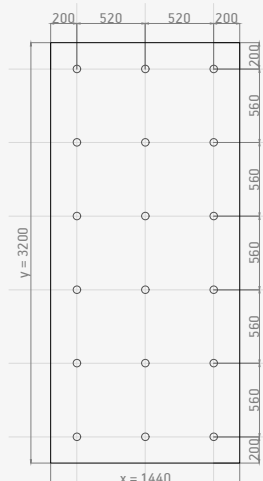

V3. Max. Design wind load: 3.5 kN/m²

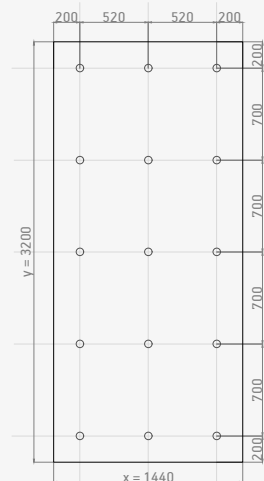

V2. Max. Design wind load: 3.0 kN/m²

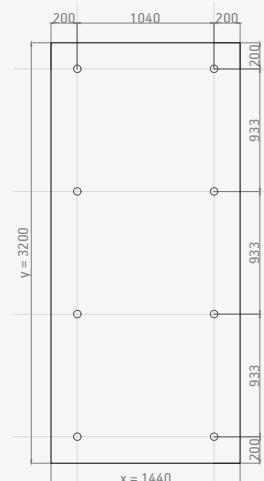

V1. Max. Design wind load: 1.5 kN/m²

CASE STUDY

Cap Ferrat by Juan Carlos di Filippo

Rio de Janeiro, Brazil

Material

3,800 m² Dekton®

Facade system

DKT1

Thickness

12 mm

For the refurbished façade of the iconic Cap Ferrat building, 3,800 m² of the ultra-compact Dekton® surface by Cosentino was used.

Cap Ferrat is an iconic residential building located on the exclusive Avenida Vieira Souto in Ipanema, Rio de Janeiro. Built in 1976, this 20 storey landmark of the Ipanema district has a surface area of 2,000m² and is home to apartments, duplexes, garages and communal areas.

Forty years after it was built, the tower underwent a project between 2013 and 2016 to refurbish the cladding of its balconies. These had deteriorated due to galvanic corrosion of the aluminium railings, which had caused the original granite cladding of the perimeter girders of the tower's six balconies to crack.

Having analysed the performance of various materials, the architectural studio in charge of the project, Di Filippo Architettura, identified Dekton® as meeting all of the essential requirements.

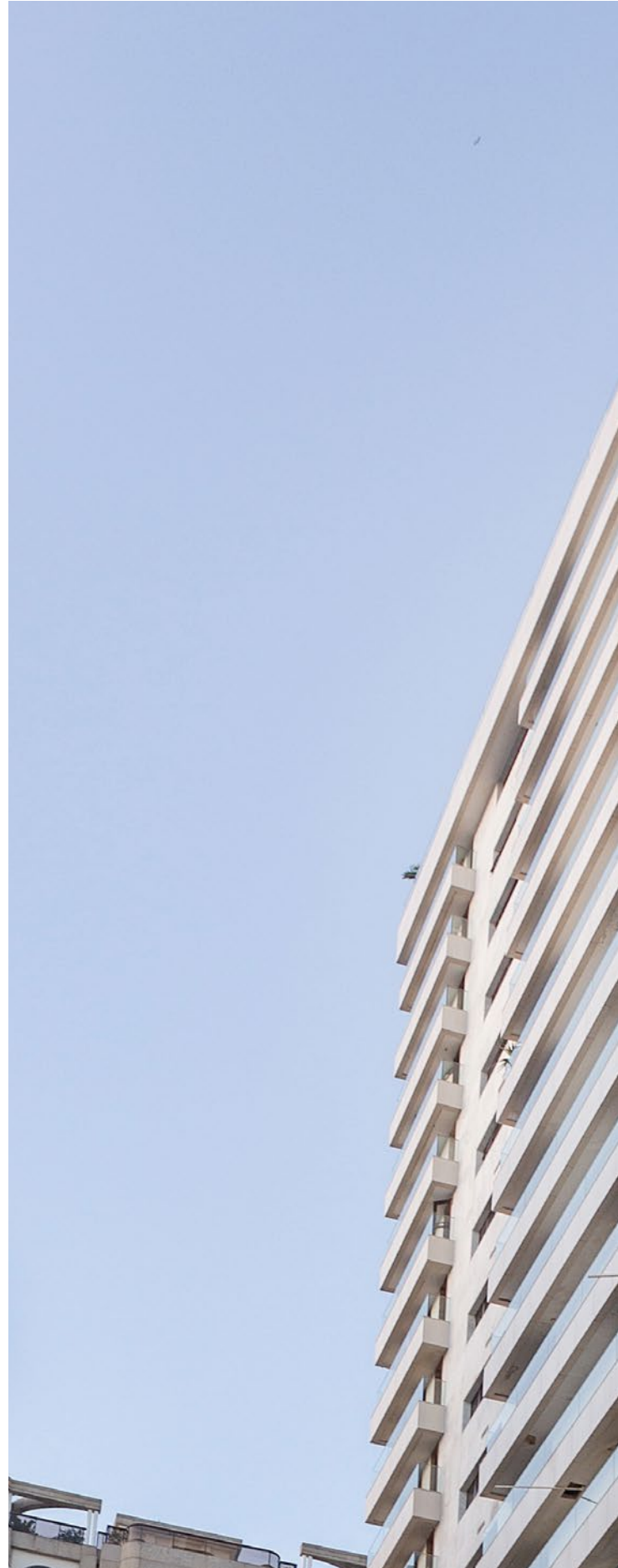



The biggest challenge faced by the project team was to find a new cladding that could be installed over the original material and would entail a maximum load of 90 kilograms per square metre. In addition, due to the building's proximity to the sea, the chosen material needed to match the exterior aesthetic with a subtle tone that blended into the surroundings as well as having mechanical properties to withstand the environmental damage that is common to such locations.

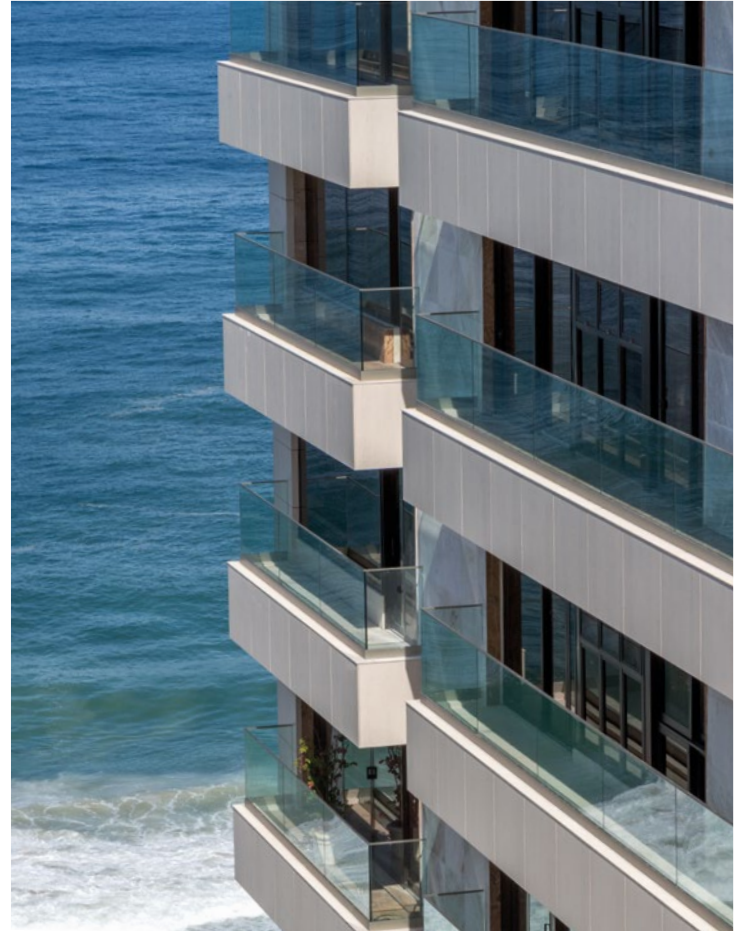

Di Filippo Architettura chose Dekton® by Cosentino for the façade for various reasons: it represented just 50% of the permitted load for the material, it can be manufactured in large format, bespoke slabs (3.2 m x 1.44 m), the precision cutting of pieces, its optimal performance against sand and saltwater erosion from the beach, and its other exceptional qualities such as its high resistance to ultraviolet rays, its colour stability and high resistance to stains.

“When we decided to maintain the existing cladding, we were faced with the need to choose a cladding material with very special characteristics: it must have minimal porosity to withstand the conditions of a coastal environment, it must be lightweight but have generous dimensions, and it must be able to be installed using a system of stainless steel fixings.

Last but not least, we needed a material with a low level of solar radiation absorption to meet the characteristics of the location, as well as being available in a colour that matched the local sand, as Cap Ferrat is located opposite Ipanema beach.

Having analysed various materials, the ultra-compact surface Dekton® by Cosentino was chosen. It fulfilled all the requirements of the project.”

Architect: Juan Carlos Di Filippo.



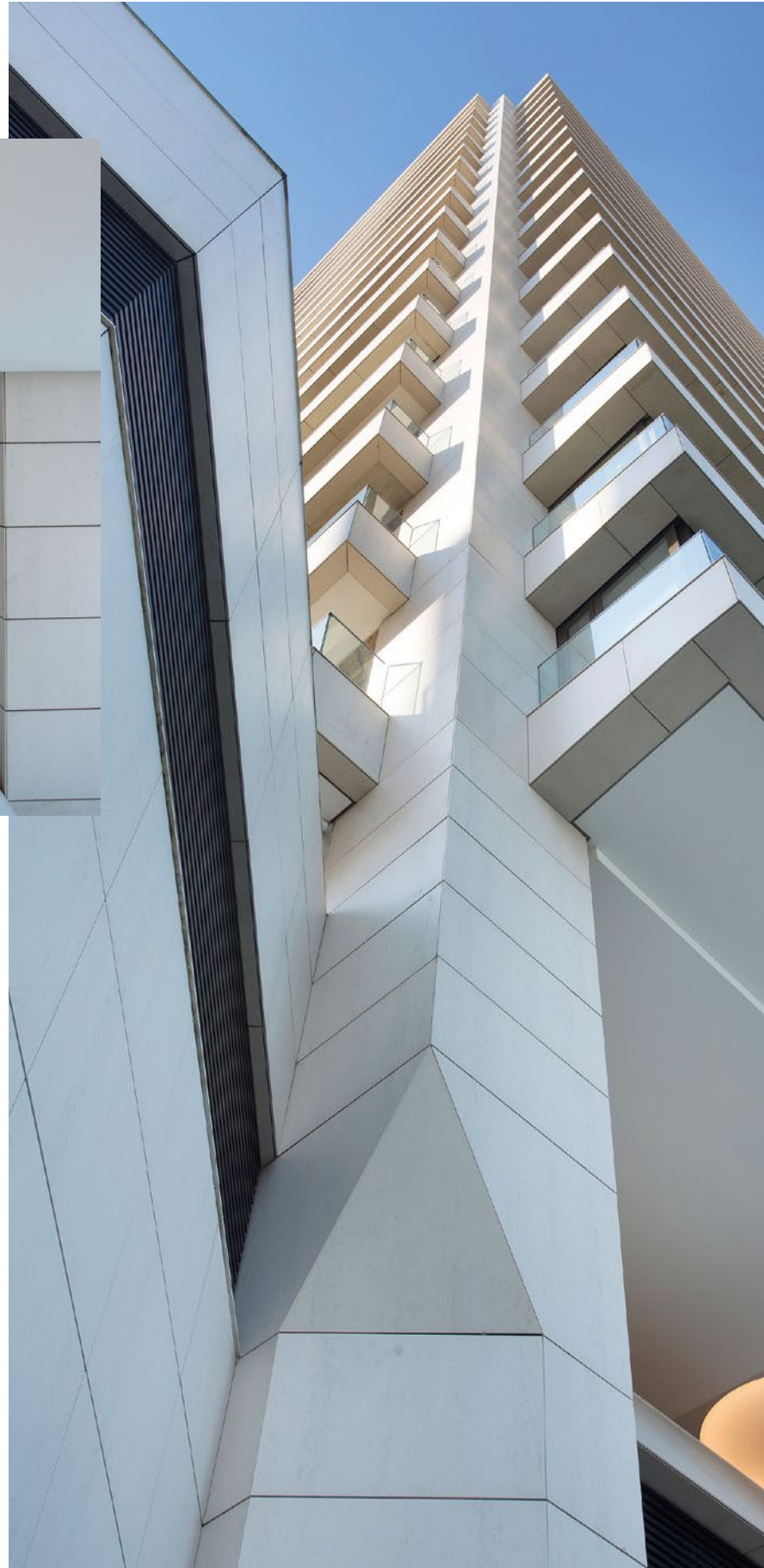

The 12mm-thick pieces were cut and the exact number, dimensions and location of holes were made at the Cosentino factory in Cantoria, Almería, before being shipped to Brazil. The holes made were the result of a ground-breaking fixing technique developed for this project by the company GMM Anchor Systems, supported throughout by the Cosentino engineering department. For the anchoring, Keil pieces provided by Cosentino were used. Other pieces and metal accessories were produced by GMM.

The Dekton® colour chosen for the façade's cladding was the cream tone Danae, for its elegance and similarity to the colour of the sand on the beach.



Project details

Name: Cap Ferrat Building

Address/location: Av. Vieira Souto, 564

Ipanema, Rio de Janeiro, Brazil

Project dates: 2013-2016

Duration of works: 12 months

Architecture studio / architects: Di Filippo Arquitectura, Juan Carlos

Di Filippo Architect - Universidad Nacional de Rosario-Argentina

Collaborators: Gabriela de Lana, Carolina Luz,

Renata Martinho, Marina Accioly

Construction / Cladding installation company: Gmm-Anchor

Systems, Sa Martins Puertas de Correr, Q-Railing Barandas

Cosentino materials:

Application: Facade

Material: Dekton® by Cosentino

Colour: Danae

Thickness: 12mm

Quantity: 3,800m²

Format: Cut to size

Installation system: Keil peg, metallic insert





CASE STUDY

MK8 Kap West

Munich, Germany

Material

13,000m² Dekton® Keon

Facade system

DKT1

Thickness

12mm

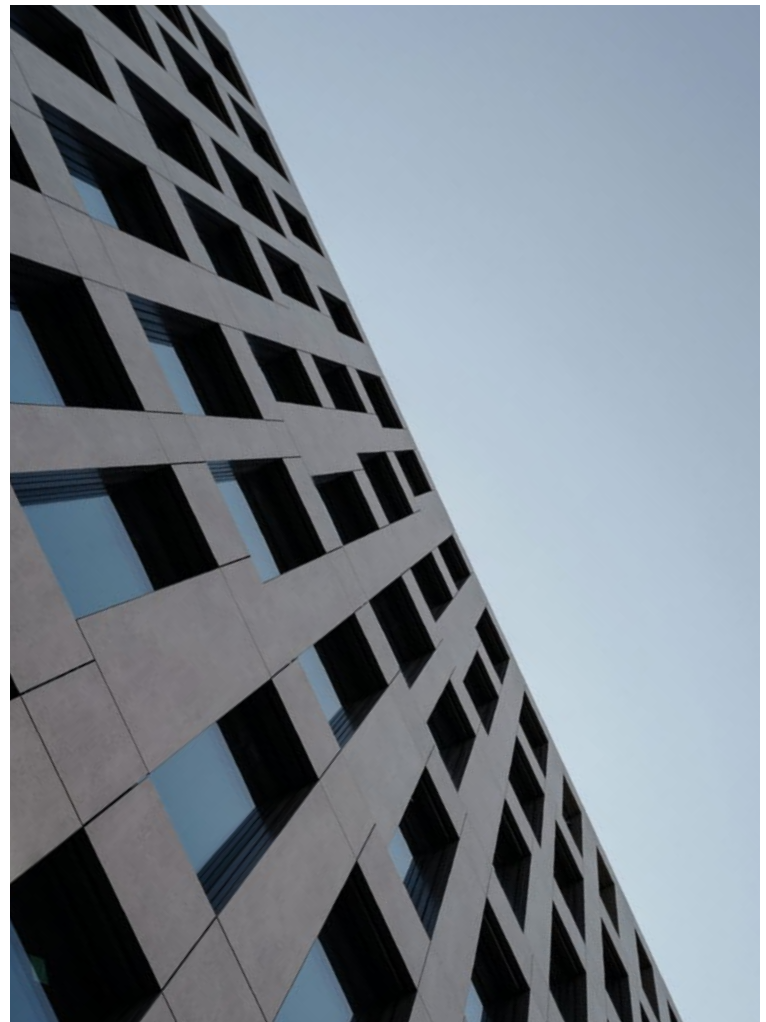



CASE STUDY

Porsche Design Store

Illinois, USA

Material

Dekton® Domoos format 320cm x 144cm
2,000 m² Dekton® Sirocco

Installation system

DKT1

Thickness

12mm



PORSCHE DESIGN



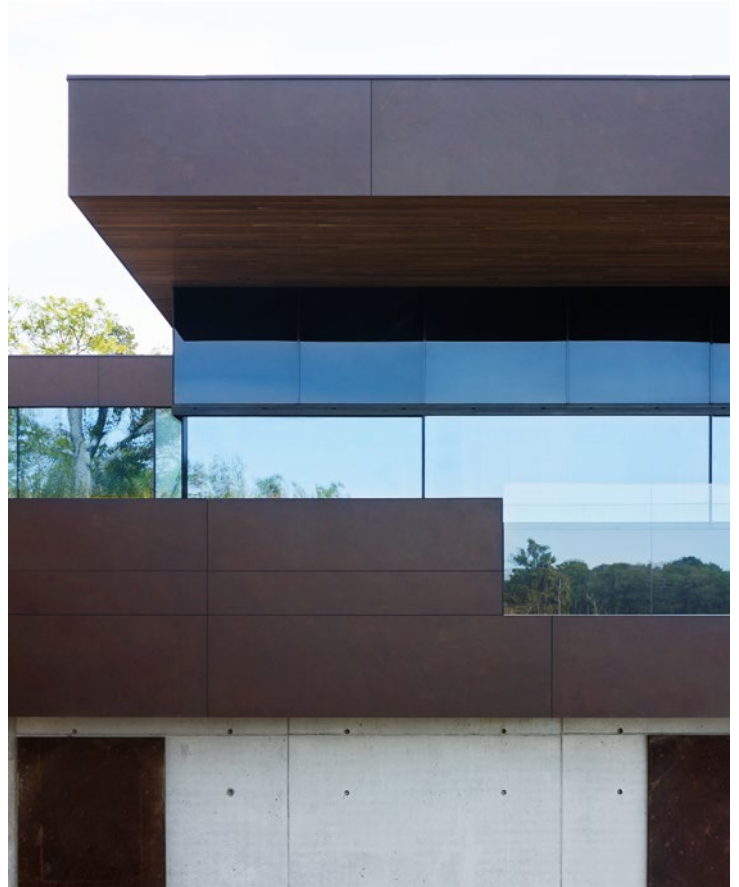

CASE STUDY

Skallan Private House

Sweden

Material

500m² Dekton® Kadum

Facade system

DKT1

Thickness

12mm



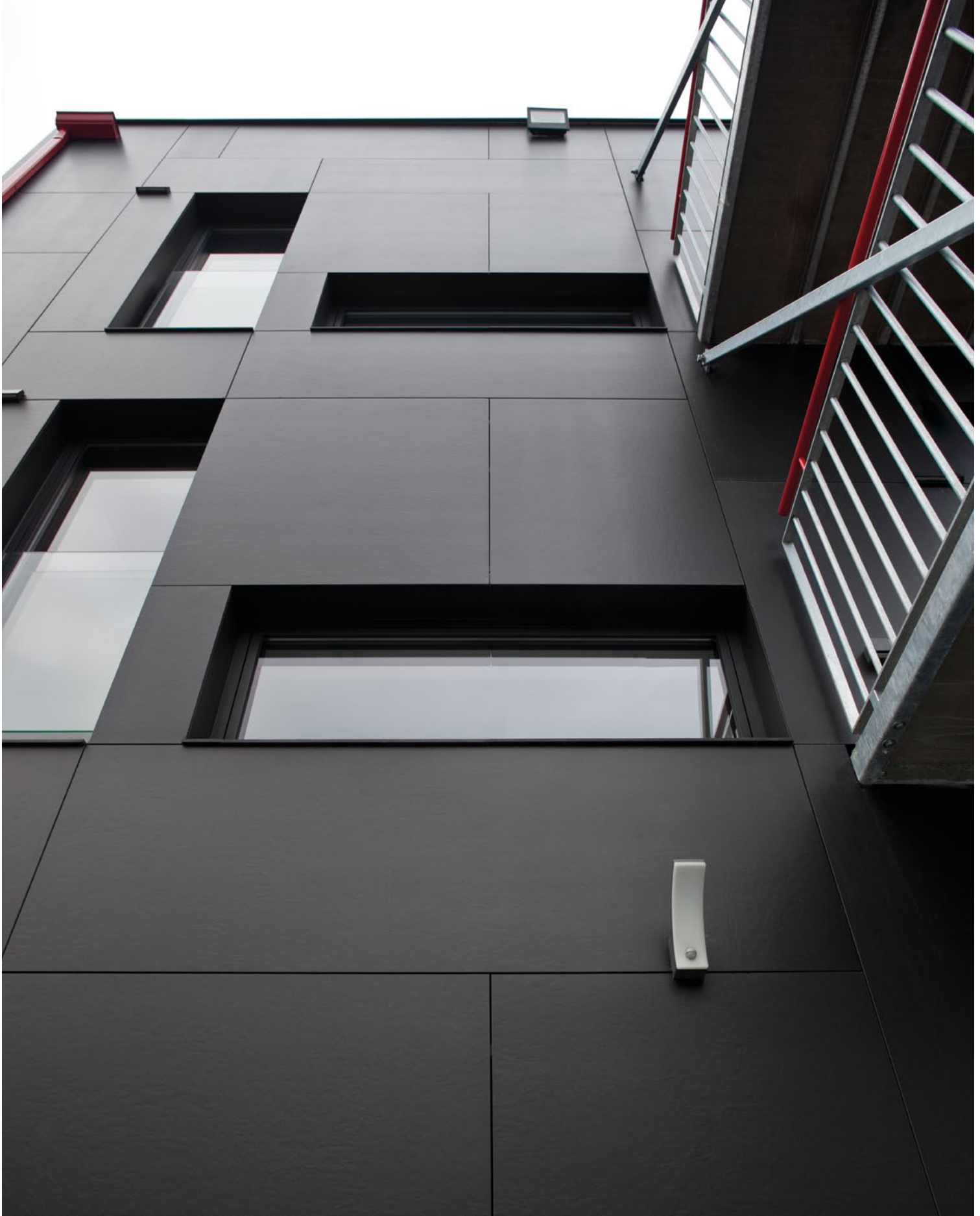



CASE STUDY

Cerceda Strow Building

A Coruña, Spain

Material

105 m² Dekton® Sirius

Facade system

DKT1

Thickness

12mm



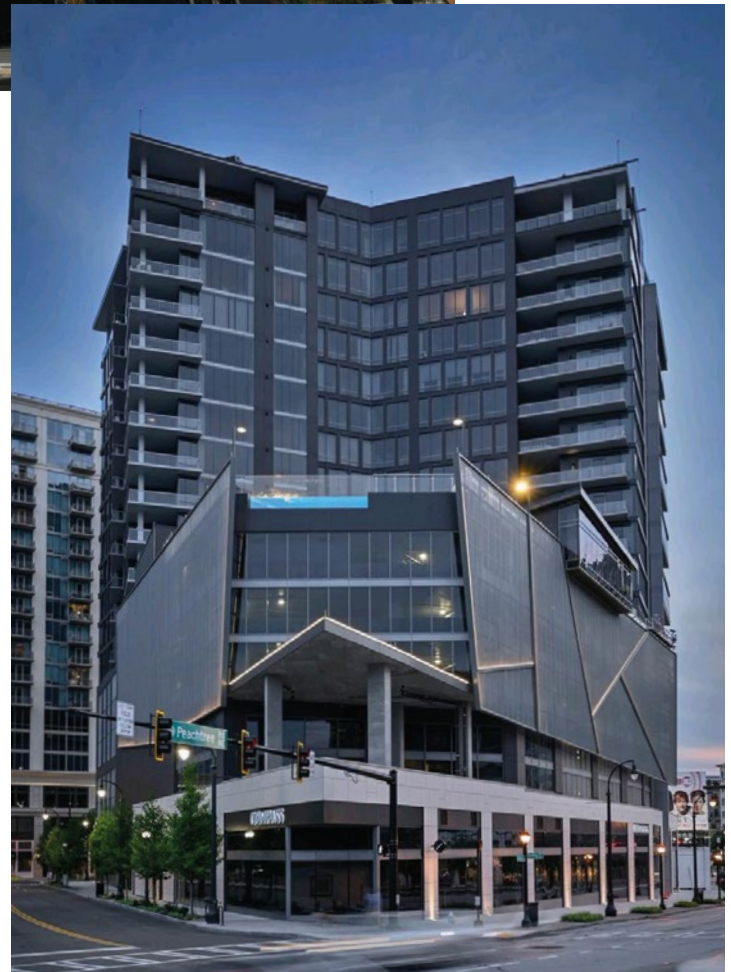

CASE STUDY

The Charles Building

Atlanta, USA

Material

1,200 m² Dekton® Domoos and Dekton® Danae

Facade system

DKT1 and DKT2

Thickness

12 and 20 mm





CASE STUDY

University of Missouri Stadium

Missouri, USA

Material

524m² Dekton[®] Domoos and Dekton[®] Spectra

Facade system

DKT1 and DKT2

Thickness

12 and 20 mm



DKT2



DK T2

Continuous Grooved Edge System

Projects with horizontal hierarchy. Some designs seek to achieve a very marked lineal frame, from spatial volume to the dimension of the construction details. The assembly as a design tool in these cases can be a major ally and help to realise this linear concept. This DKT2 system comprises of a horizontal profile that supports the face in a continuous way, all

based on a groove that runs the whole length of the piece.

This solution creates an almost hermetic ventilated chamber, due to the continuity of the supporting profile itself. A groove of 3-4 mm minimum and with a depth of up to 10 mm is required to conceal the length-wise profile that is anchored to the uprights of the sub-structure.



This solution creates an almost hermetic ventilated chamber, due to the continuity of the supporting profile itself. Dekton® has the certification for ventilated façades according to ETA 14/0413 and BBA 16/5346 for 12mm and 20mm thicknesses, although it can also be used with 30mm.

Hidden mechanical fixing with metallic profile on the continuous groove of the edge of the piece.

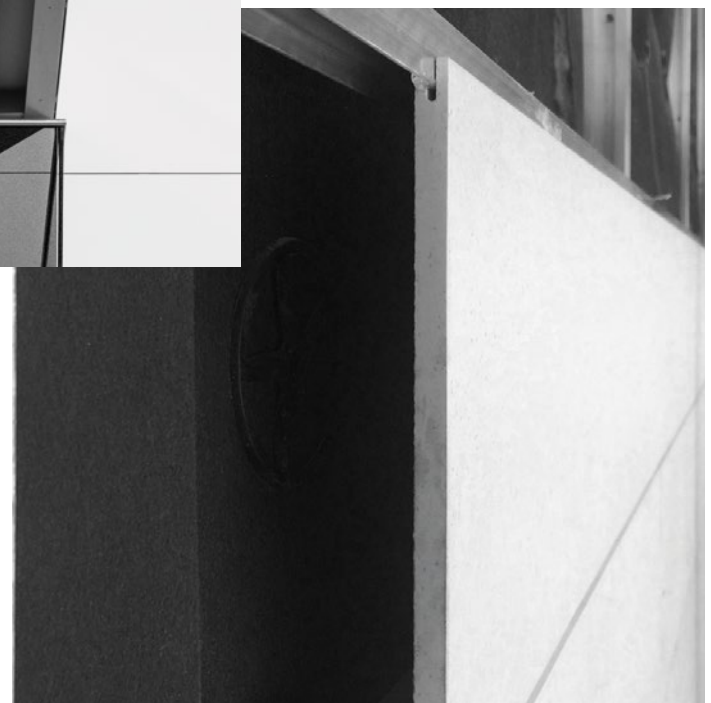

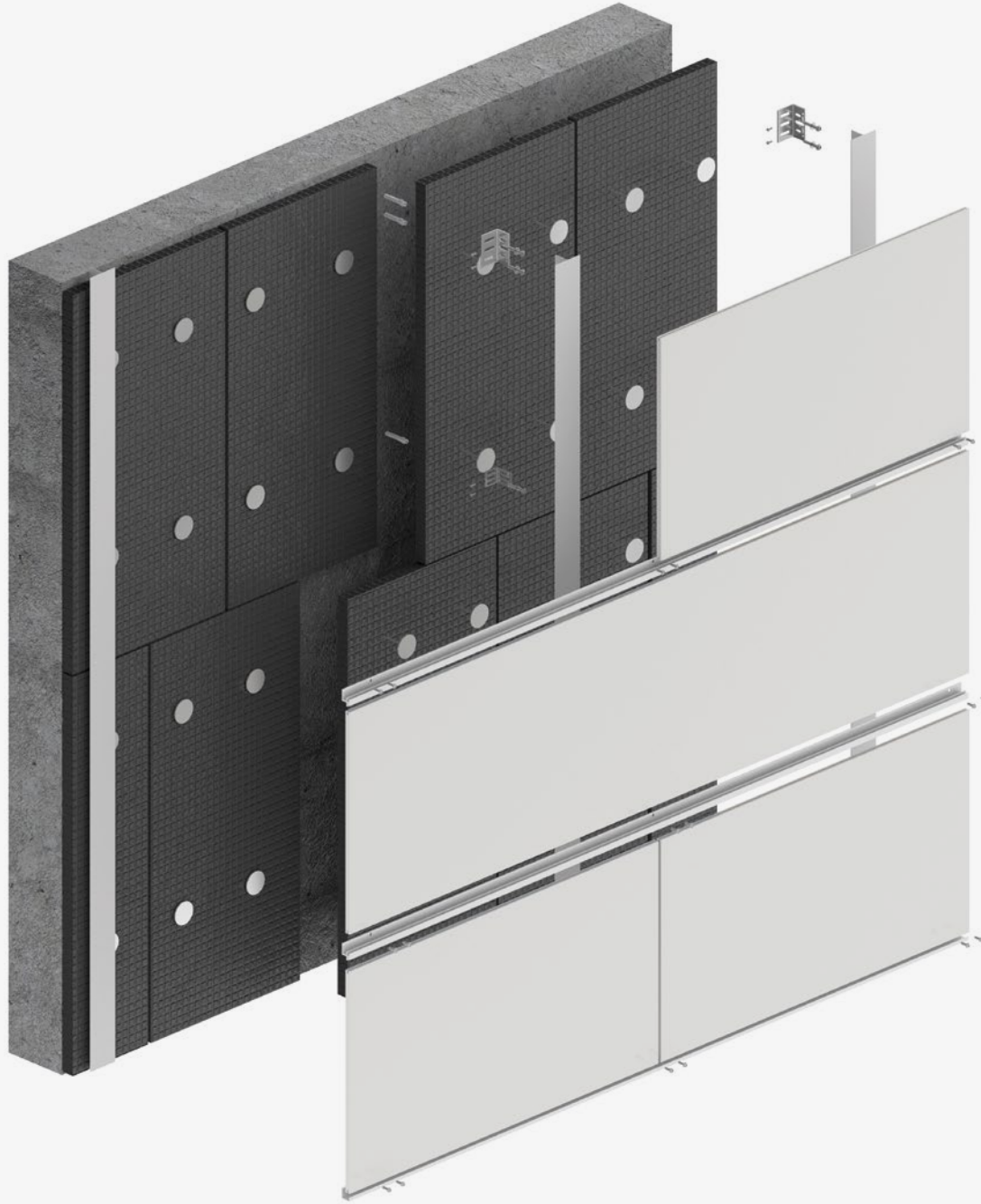

DKT2 - Diagram

System detail

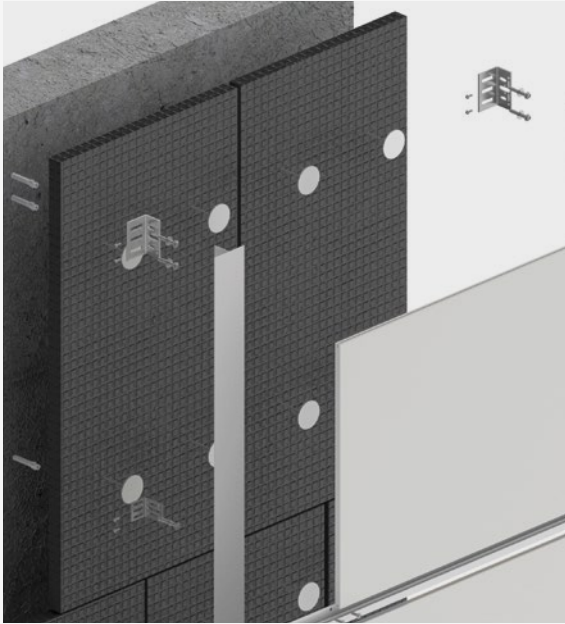

Middle profile detail



Bottom profile

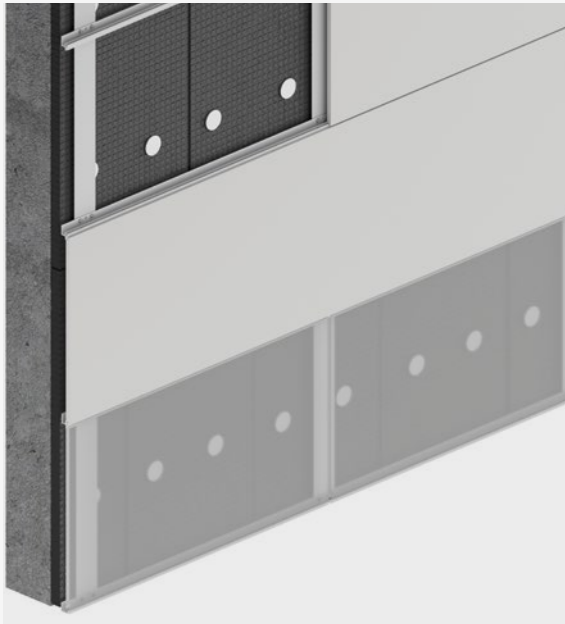

Bottom profile detail

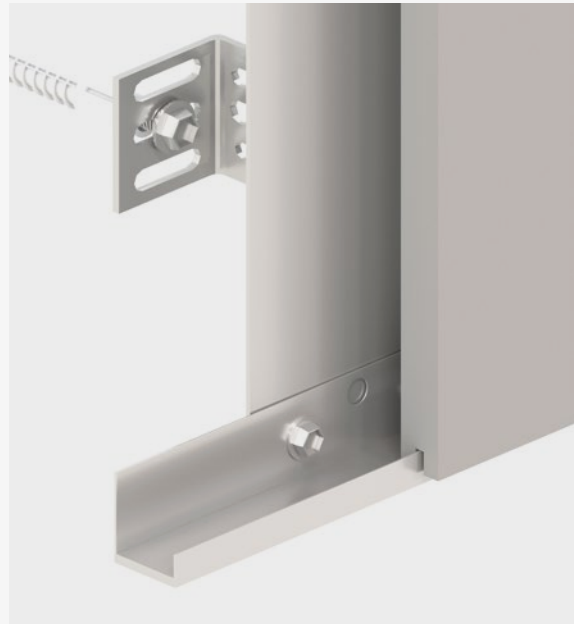

Note: The following fixing configurations are based only on Dekton material resistance; the number and dimensions of the clamps or profiles needed should be engineered by the system supplier.

DKT2 Structure



Secondary structure and general fixing instructions

1. Define the layout of the horizontal profiles over the vertical substructure.
2. Drill the vertical profile to fix the horizontal rails from bottom to top on the facade so the grooved edge Dekton® slab can be placed on it.
3. Place the horizontal rail over one piece, insert inside the top grooves of the piece. Level and fix it to the vertical profiles.
4. Enter the rest of the pieces from the row, using spacers to achieve the desired gap for vertical joints.
5. For some systems, the installation process may require installing first both bottom and top horizontal profiles. If so insert Dekton® pieces into the top groove first and then into the bottom profile.
6. Repeat the process for all rows until the top, installing a top-end profile on the top row pieces.
7. The maximum cantilever distance of horizontal rails must be defined by the system supplier.

Installation sequence from one side to another and from bottom to top

Fig. 1

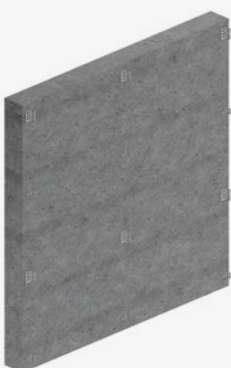

Fig. 2

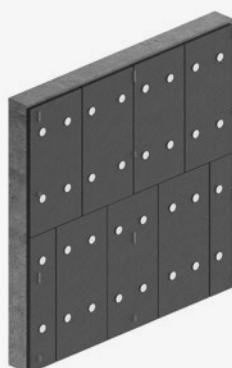

Fig. 3

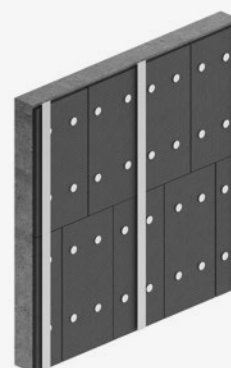

Fig. 4

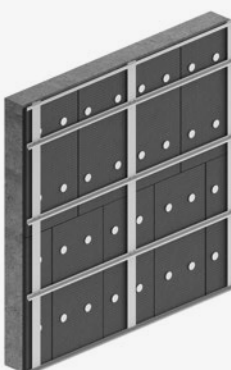

Fig. 5

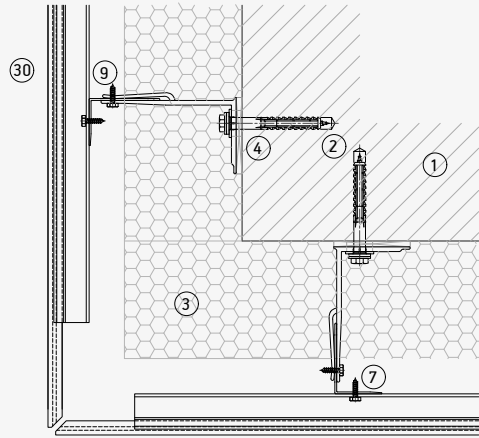

Fig. 6



DKT2 Horizontal section

Mitered external corner



Internal Corner

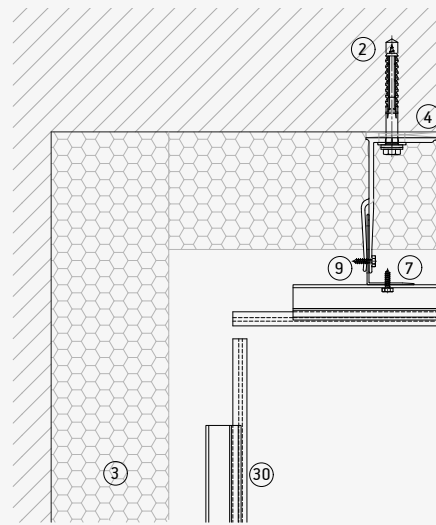

Vertical joint

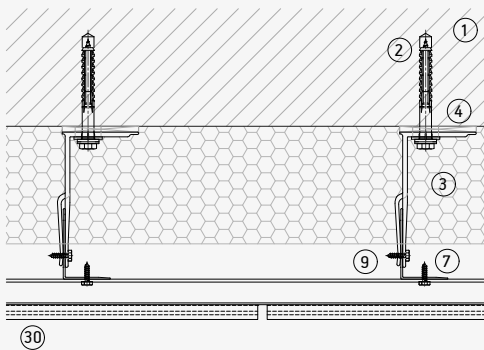

Vertical expansion joint

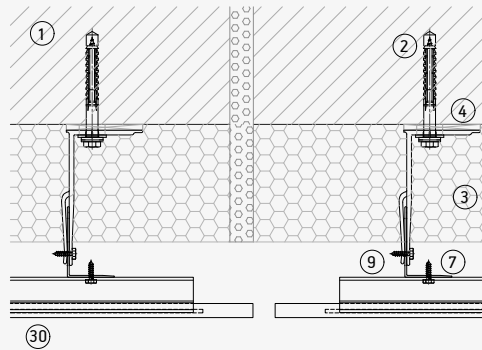

- 1. Supporting wall.
- 2. Anchor bracket.
- 3. Insulation.
- 4. Insulating layer.
- 5. Fixed bracket.
- 6. Adjustable bracket.
- 7. L profile.
- 8. T profile.
- 9. Self tapping screw.

- 10. Rivet.
- 11. Undercut anchor.
- 12. Horizontal rail.
- 13. C hanger.
- 14. Adjustable C hanger.
- 15. Bottom/top edge profile/clip.
- 16. Intermediate edge profile/clip.

- 17. Bottom/top visible clamp.
- 18. Intermediate visible clamp.
- 19. Interior back clamp
- 20. Exterior back profile
- 21. Chemical fixing system
- 22. Security fixing
- 23. Ventilation profile

- 24. Lintel
- 25. Jamb
- 26. Window sill
- 27. Top coping
- 28. Corner profile
- 29. Bonding adhesive
- 30. Dekton

DKT2 Vertical section

Upper detail

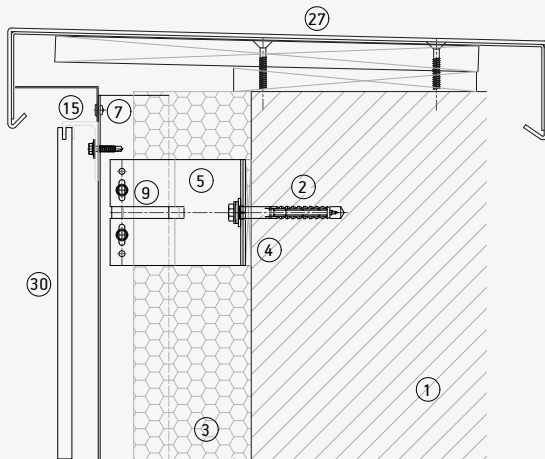

Bottom detail

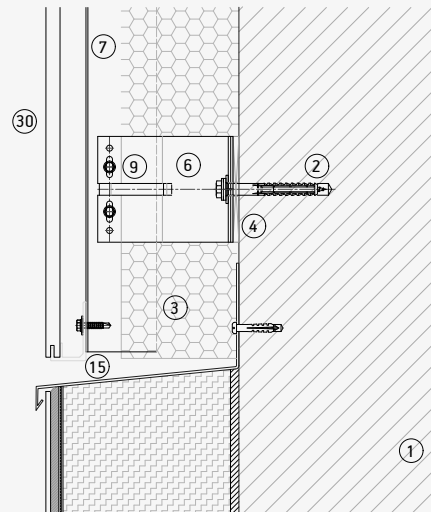

Horiozntal joint

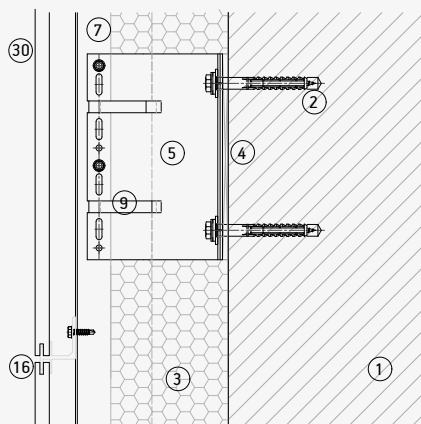

Joint between profiles

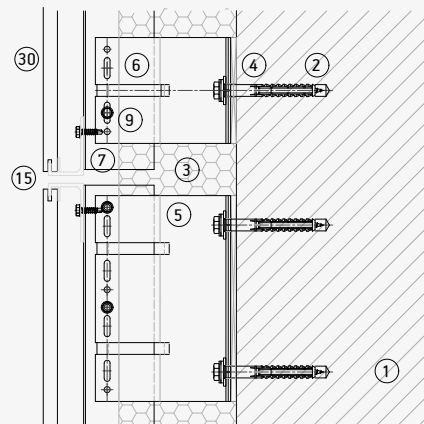

- | | | | |
|------------------------|-------------------------------------|---------------------------------|----------------------|
| 1. Supporting wall. | 10. Rivet. | 17. Bottom/top visible clamp. | 24. Lintel |
| 2. Anchor bracket. | 11. Undercut anchor. | 18. Intermediate visible clamp. | 25. Jamb |
| 3. Insulation. | 12. Horizontal rail. | 19. Interior back clamp | 26. Window sill |
| 4. Insulating layer. | 13. C hanger. | 20. Exterior back profile | 27. Top coping |
| 5. Fixed bracket. | 14. Adjustable C hanger. | 21. Chemical fixing system | 28. Corner profile |
| 6. Adjustable bracket. | 15. Bottom/top edge profile/clip. | 22. Security fixing | 29. Bonding adhesive |
| 7. L profile. | 16. Intermediate edge profile/clip. | 23. Ventilation profile | 30. Dekton |
| 8. T profile. | | | |
| 9. Self tapping screw. | | | |

DKT2 System Description

Hidden system

Supporting substructure made up of; metal brackets, adjustable for correction of unevenness compatible with different types of supports, can include thermal break insulator; vertical metal profiles of different sections according to the required application; continuous horizontal metal profiles type H-Carrier/Rail; hidden anchorage system by means of continuous grooving in the Dekton® panel for fixing by insertion.

Installation process

Brackets installed on the surface to be covered by means of a mechanical system or welding; vertical profiles installed on brackets with a system of regulation and fixing, by means of specific screws*; continuous horizontal H-Type profiles with a system of regulation and fixing, installed by means of specific screws* on vertical profiles; positioning of the lower edge of the Dekton® panel on continuous H-Carrier/Rail profile; installation of the blocking device on the upper part, continuous H-Carrier/Rail profile.

*Specific screws according to the structural calculation of each project or indicated by the supplier of the substructure.

The minimum width of the grooves is 3mm, and the depth of grooving typically goes 10mm. Groove dimensions need to be defined for each project according to the Dekton thickness chosen and the project static calculations.

Cutting and machining

At the Cosentino Factory all slabs can be cut and machined following project drawings and delivered to site in the desired order.

Please consult with the Project Service Unit department for special project requirements.

Grooves can be done following provided project details and static calculations.

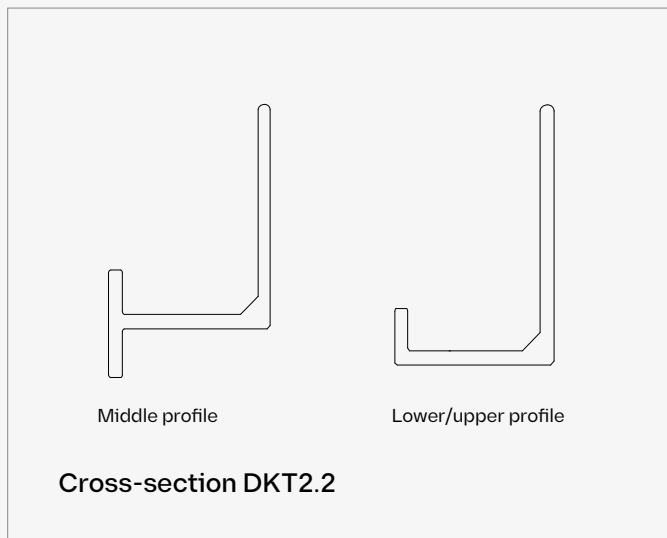
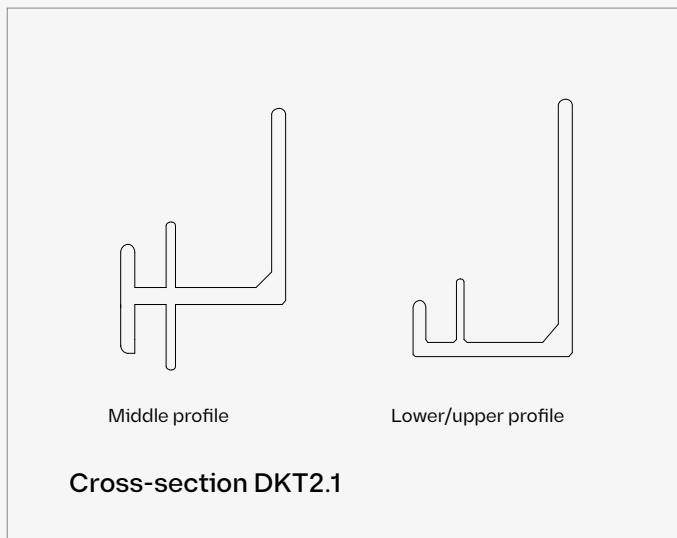
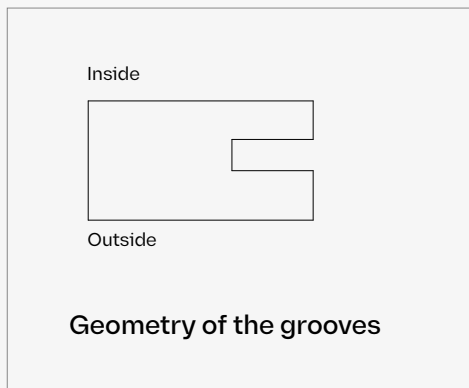

DKT2 Structure

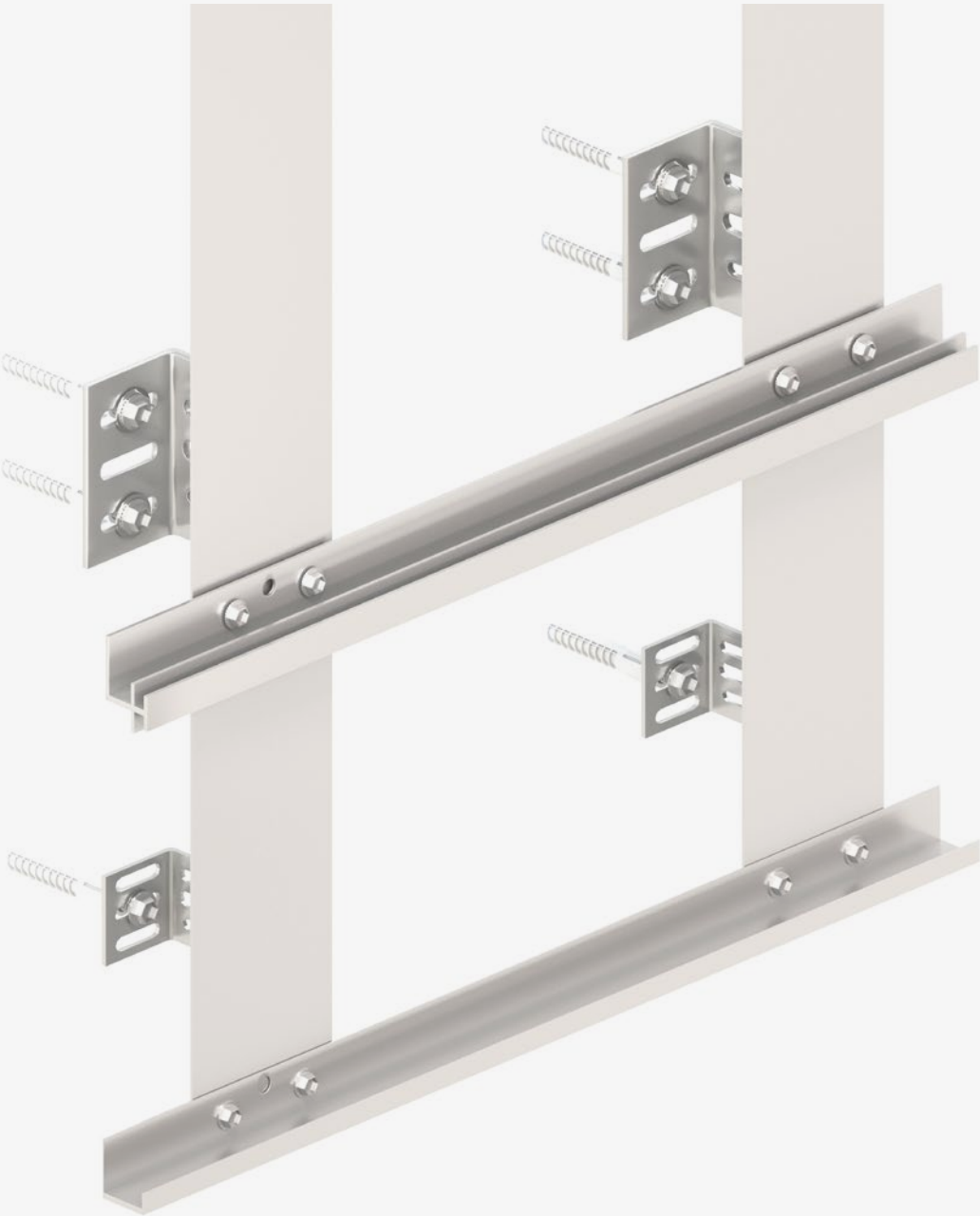

DKT2 Static Calculations

Schemes and data to be defined with SDP software

Panel in horizontal or vertical layout. Maximum wind loads shown in the following configurations depend on the grid spacing and distance from drill holes to the edges.

These configurations have been calculated considering a distance of fixing to edges of 200mm. For further distances and configurations please consult with our Technical Department.

The tables and diagrams presented are based on Dekton calculation software and refer only to Dekton®. They cannot be considered as definitive data for on-site installation and it is necessary for a qualified technician

to make a specific project calculation for the entire façade system including support anchors, brackets, profiles, screws and Dekton® fixing elements to the façade

How to use the reference configurations:

- Determine the design wind load kN/m^2 .
- Choose the table according to the fixing system and Dekton thickness.
- Select the closest design wind load. The wind load chosen should not be less than actual requirements.
- Select a reference configuration showing maximum spacing between fixings.

DKT2

Dekton 12mm

Full slab configuration

Design wind load kN/m^2	Horizontal	Spacing between hor. profiles (mm)
0.5	H2	1200
1	H4	900
1.5	H6	600
2	H8	400
6	H10	170

Dekton 20mm

Full slab configuration

Design wind load kN/m^2	Horizontal	Spacing between hor. profiles (mm)
0.5	H1	1440
1	H3	1000
1.5	H5	650
2	H7	500
5.5	H9	350

DKT2 Layout

Design wind loads to be compared with reference design wind loads provided in this document should have applied wind load factors on characteristic values per applicable standards and regulations.

Design wind loads and fixing distances should be calculated per local standards, regulations and certificates applicable, with further testing if required.

Cosentino will not accept any liability whatsoever for any direct or indirect damage resulting from any errors, omissions or miscalculations of the static calculations for the project.

Cosentino does not provide static calculations for projects.

12mm

HORIZONTAL CONFIGURATION

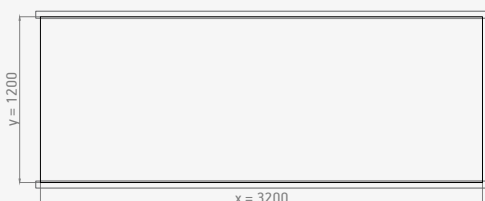

H2. Max. Design wind load: 0.5 kN/m²

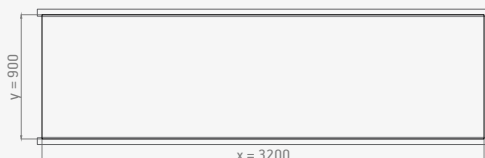

H4. Max. Design wind load: 1.0 kN/m²

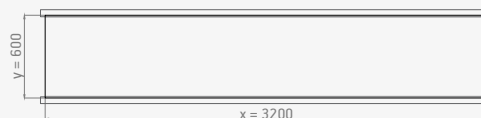

H6. Max. Design wind load: 1.5 kN/m²

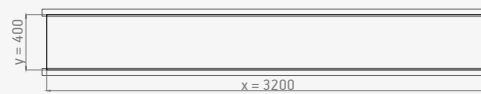

H8. Max. Design wind load: 2.0 kN/m²

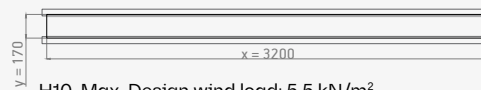

H10. Max. Design wind load: 5.5 kN/m²

20mm

HORIZONTAL CONFIGURATION

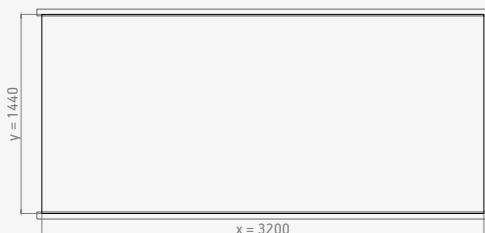

H1. Max. Design wind load: 0.5 kN/m²

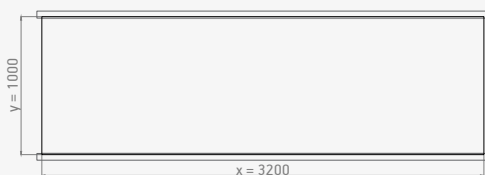

H3. Max. Design wind load: 1.0 kN/m²

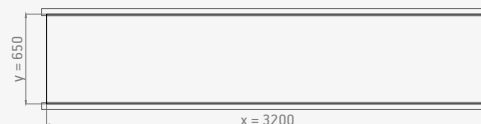

H5. Máx. Design wind load: 1.5 kN/m²

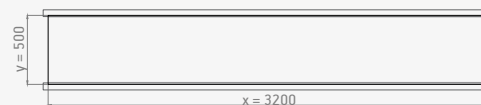

H7. Max. Design wind load: 2.0 kN/m²

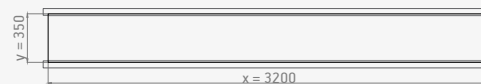

H9. Max. Design wind load: 6.0 kN/m²



CASE STUDY

Valdebebas 127

Madrid, Spain

Material

7,600m² Dekton® Warm (customised) and Korus

Installation system

DKT2

Thickness

12mm









CASE STUDY

LD Hotel

Sevilla, Spain

Material

2,500 m² Dekton® Keon

Facade system

DKT2

Thickness

12mm

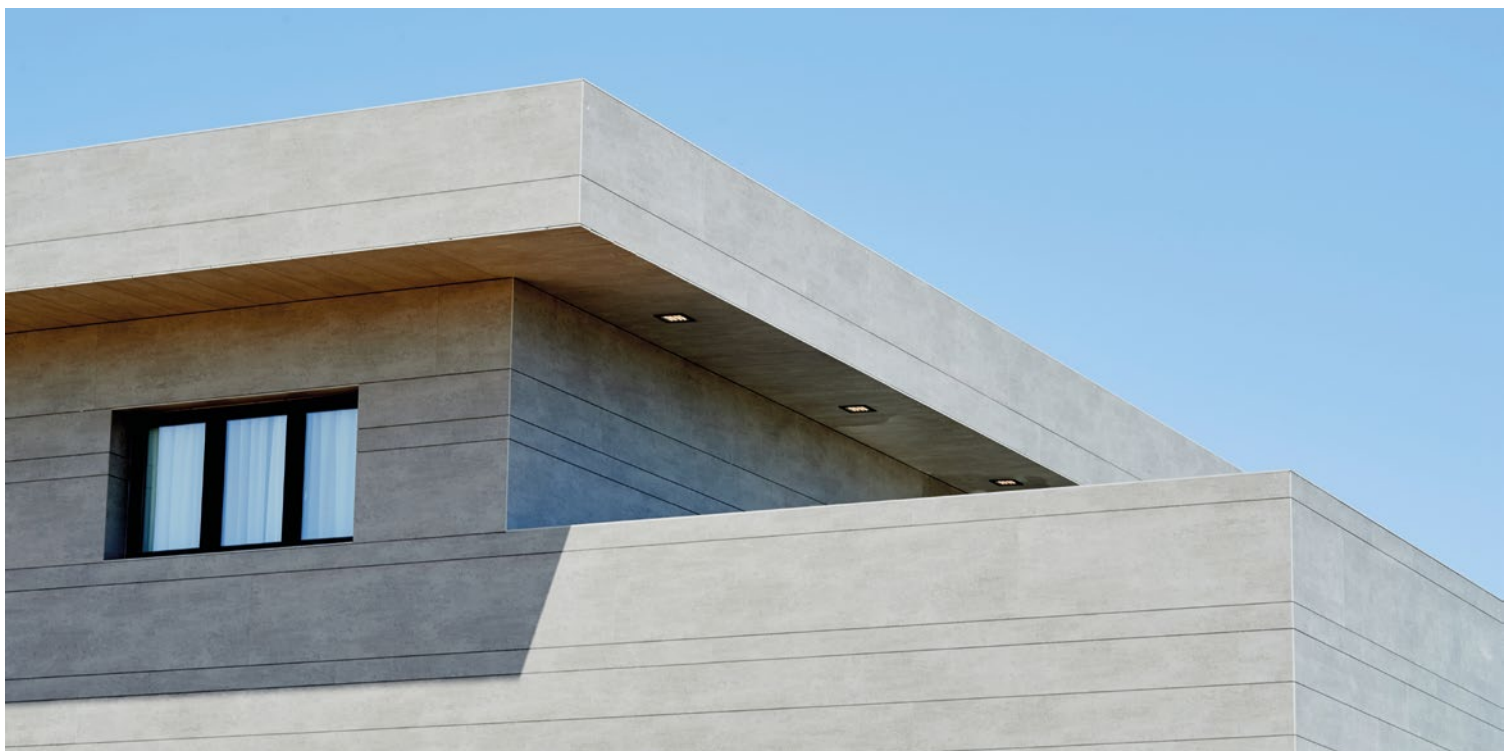
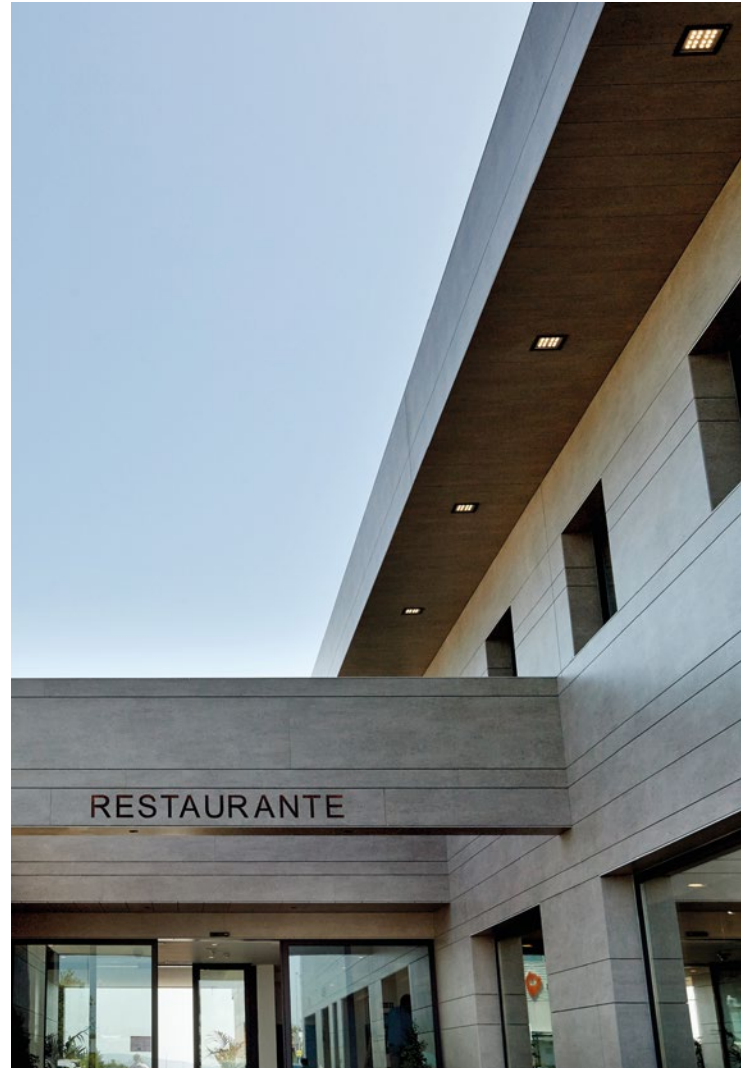



DK T3

Edge Grooving and Spot clips

In the DKT3 system, pieces are fastened to the profile by hidden clips that are inserted at intervals along a continuous groove at the edge of the piece, which can end at 3 cm at each extreme, thereby improving the aesthetics and functionality of the lateral pieces. This system is fairly flexible, although there are certain dimensional limits, as the maximum a piece can be for

12mm thickness is 70cm vertical and 100cm for 20mm thickness.

In cases that require a greater dimension on the vertical section, 30mm thickness should be used to counteract fatigue on the grooved part of the material from the anchoring.



Dekton® has the certification for ventilated façades according to ETA 14/0413 and BBA 16/5346 for 12mm and 20mm thicknesses, although it can be used for other non-certified thicknesses.

Hidden mechanical fixing
with clips at intervals
along the groove on the
edge of the piece.



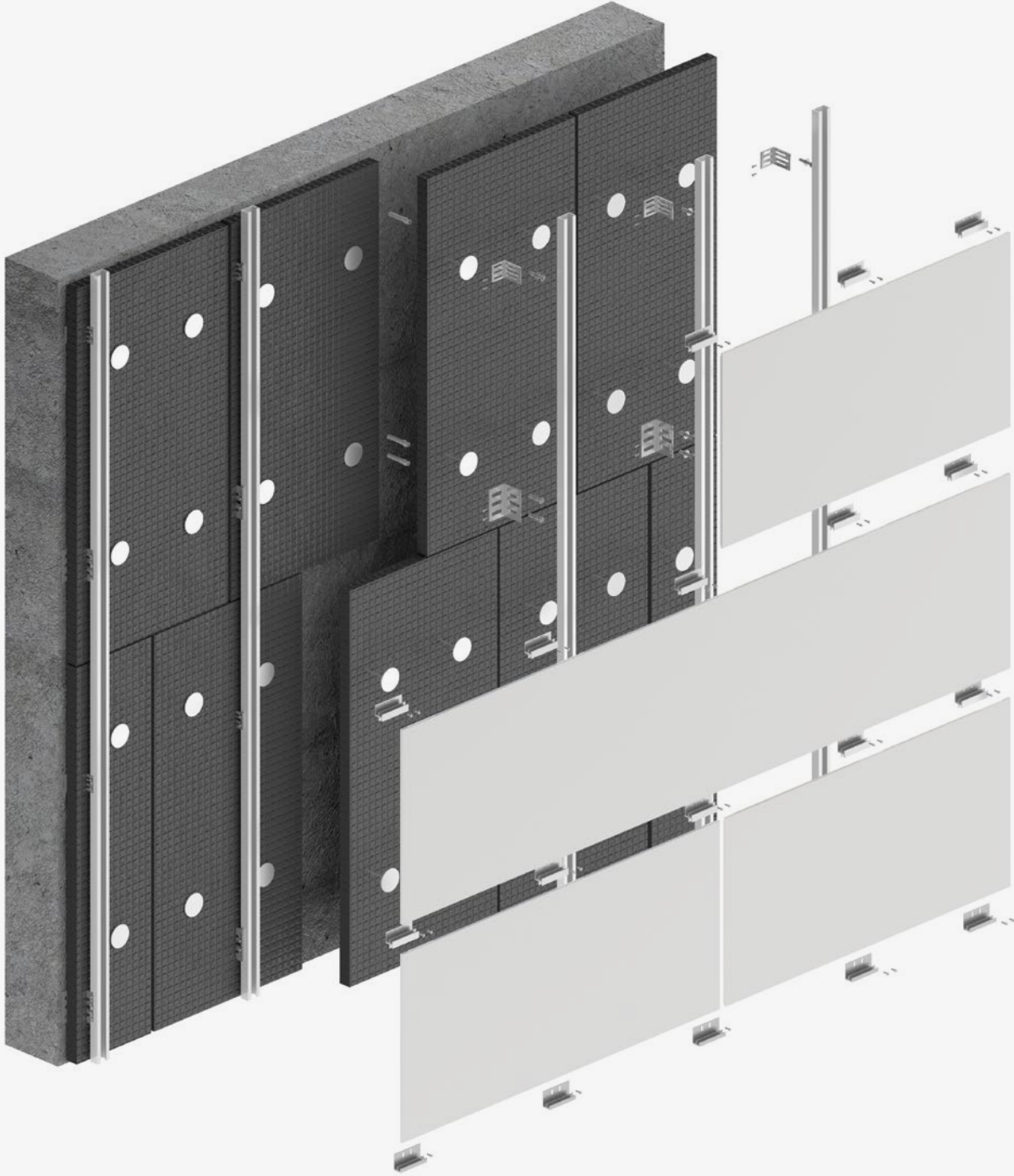

DKT3 - Diagram

Joints

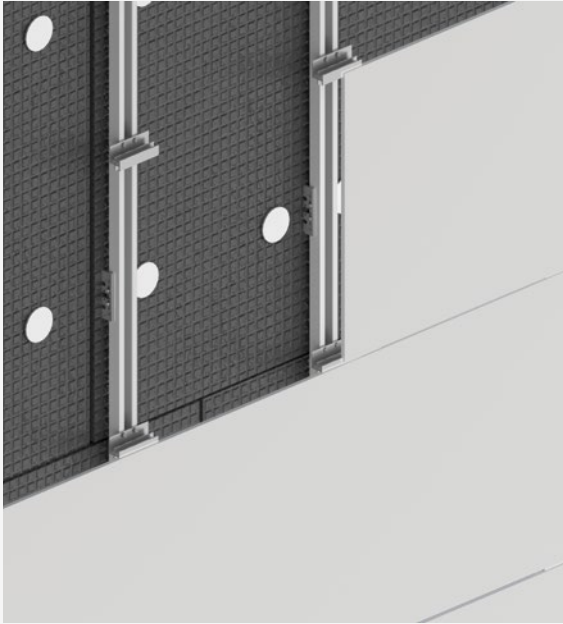

Middle clips

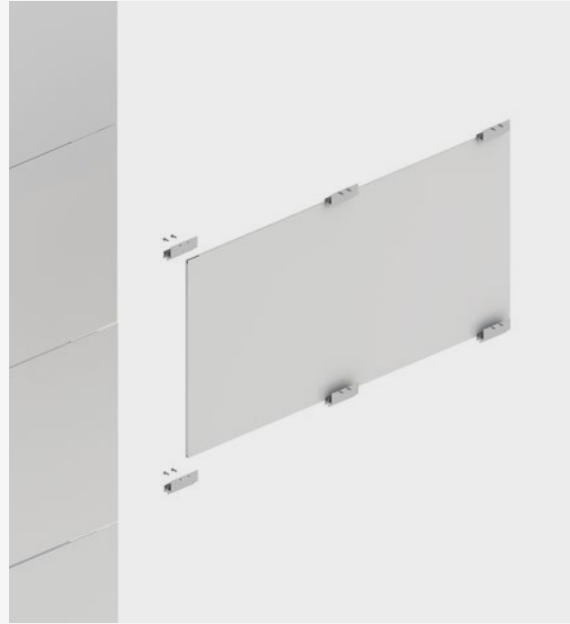

Bottom clips



Bottom clips detail

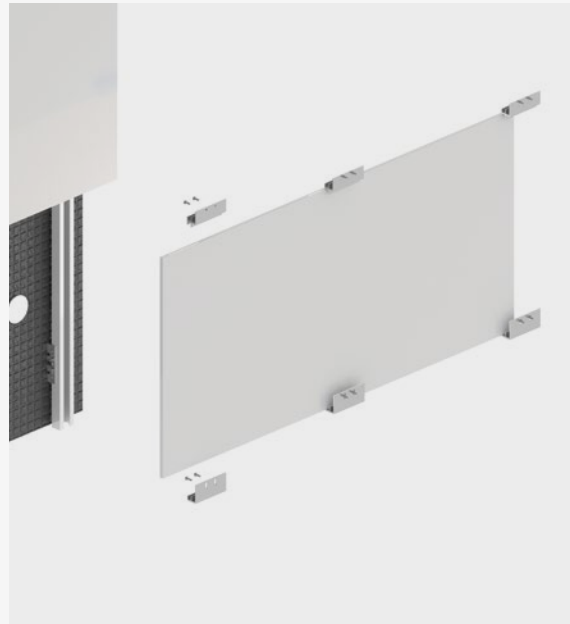

Note: The following fixing configurations are based only on Dekton material resistance; the number and dimensions of the clips or profiles needed should be defined by the system supplier.

DKT3 Structure



General fixing instructions

1. Define the layout and position of the clips over the vertical substructure.
2. In some clip systems, a spring is installed into the vertical profiles before fixing the clips, in order to avoid looseness between the Dekton® piece and vertical profiles.
3. Screw the bottom clips to the vertical profiles.
4. Place the Dekton® piece with grooved edges laying on the clips, that will support the piece weight.
5. Place the intermediate clips, inserting the tabs into the top grooves of the Dekton® piece and screw the clips to the vertical profiles.
6. Repeat the process by placing another piece over the installed clips and fixing with upper clips.
7. Finish with the top pieces. Installing a top-end clip with a slotted hole and screw them to the vertical profile. Insert the clips into the top groove of the panel by adjusting its position vertically.
8. Maximum cantilever distance of horizontal rails must be defined by the system supplier.

Installation sequence from one side to another and from bottom to top

Fig. 1



Fig. 2



Fig. 3



Fig. 4



Fig. 5



Fig. 6



DKT3 System Description

Hidden system

Supporting substructure made up of; metal brackets, adjustable to correct unevenness and compatible with different types of supports, can include thermal break insulators; vertical metal profiles of different sections according to the application required; horizontal metal profiles or H-Carrier/Rail or J-Carrier/Rail type clips; hidden anchoring system by means of continuous grooving in the Dekton Panel for fixing by insertion.

Installation process

Brackets installed on the surface to be covered by means of a mechanical or welding system; vertical profiles installed on brackets with a regulation and fixing system, by means of specific screws*; specific horizontal profiles or H-Carrier/Rail or J-Carrier/Rail clip with a regulation and fastening system, installed by means of specific screws* on vertical profiles; Installation of the lower edge of the Dekton® panel on a point profile or H-Carrier/Rail or J-Carrier/Rail clip; installation of the locking device on the upper part, point profile or H-Carrier/Rail or J-Carrier/Rail clip.

*Specific screws according to the structural calculation of each project or indicated by the supplier of the substructure.

The minimum width of the grooves is 3mm, and the depth of grooving typically goes from 10mm to 15mm. Groove dimensions need to be defined for each project according to the Dekton thickness chosen and the project static calculations.

Cutting and machining

At the Cosentino Factory all slabs can be cut and machined following project drawings and delivered to site in the desired order.

Please consult with the Project Service Unit department for special project requirements.

Grooves can be made following provided project details and static calculations.

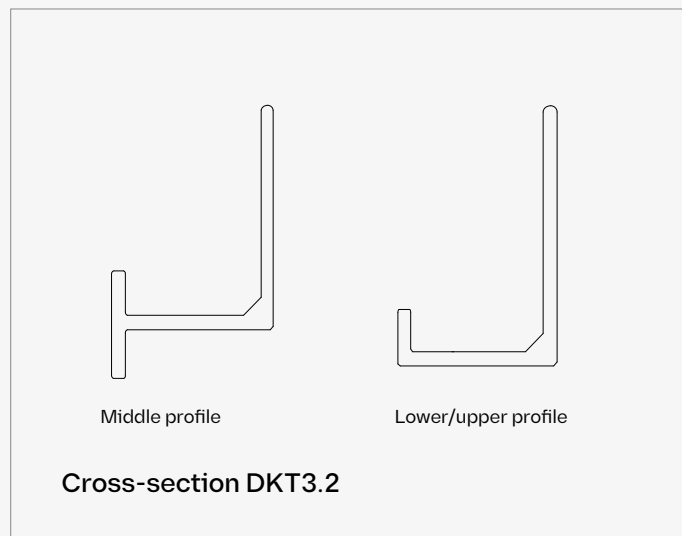
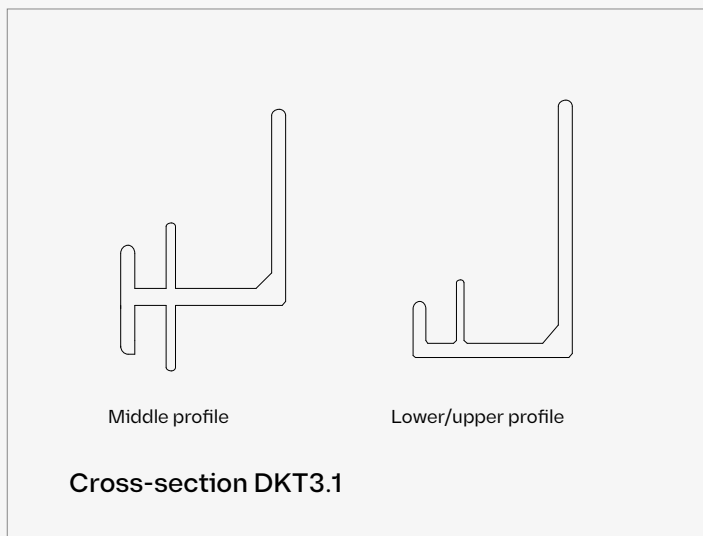
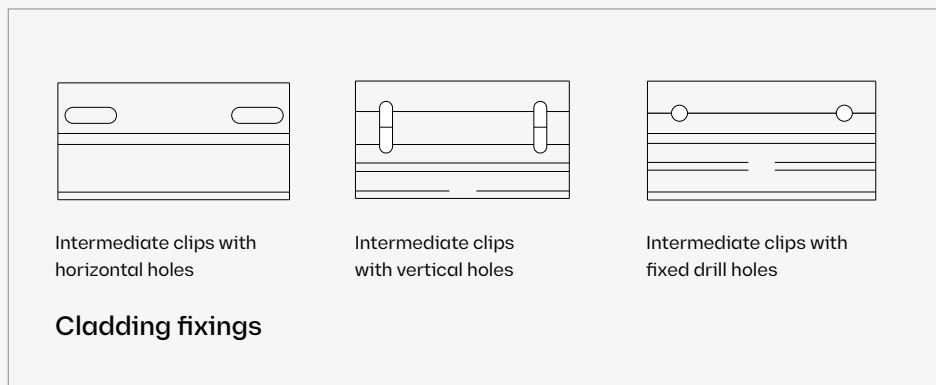
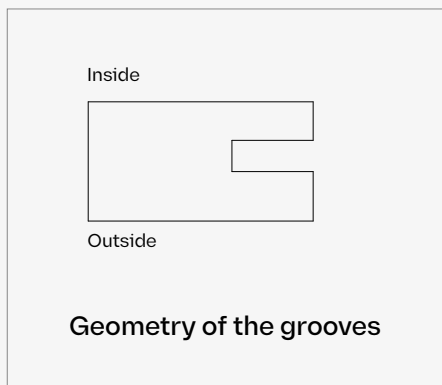

DKT3 Horizontal section

Mitered external corner

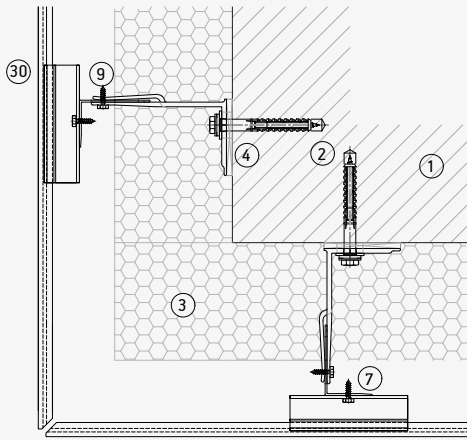

Internal Corner

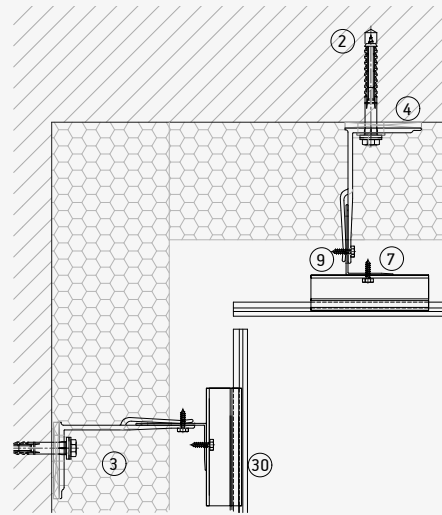

Vertical joint

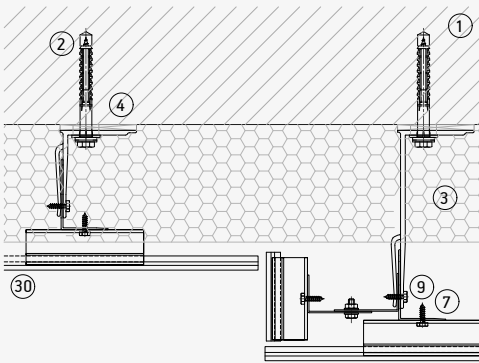

Vertical expansion joint

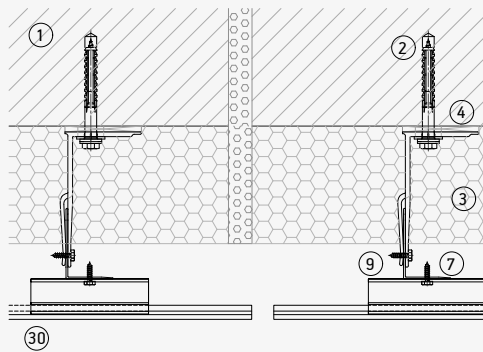

- | | | | |
|------------------------|-------------------------------------|--------------------------------|----------------------|
| 1. Supporting wall. | 10. Rivet. | 17. Bottom/top visible clip. | 26. Window sill |
| 2. Anchor bracket. | 11. Undercut anchor. | 18. Intermediate visible clip. | 27. Top coping |
| 3. Insulation. | 12. Horizontal rail. | 19. Interior back clip | 28. Corner profile |
| 4. Insulating layer. | 13. C hanger. | 20. Exterior back profile | 29. Bonding adhesive |
| 5. Fixed bracket. | 14. Adjustable C hanger. | 21. Chemical fixing system | 30. Dekton |
| 6. Adjustable bracket. | 15. Bottom/top edge profile/clip. | 22. Security fixing | |
| 7. L profile. | 16. Intermediate edge profile/clip. | 23. Ventilation profile | |
| 8. T profile. | | 24. Lintel | |
| 9. Self tapping screw. | | 25. Jamb | |

DKT3 Vertical section

Upper detail

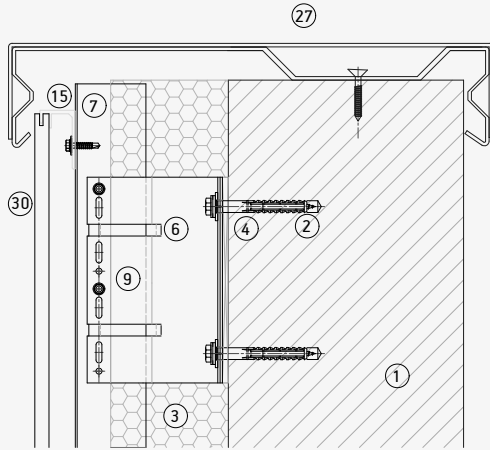

Bottom detail

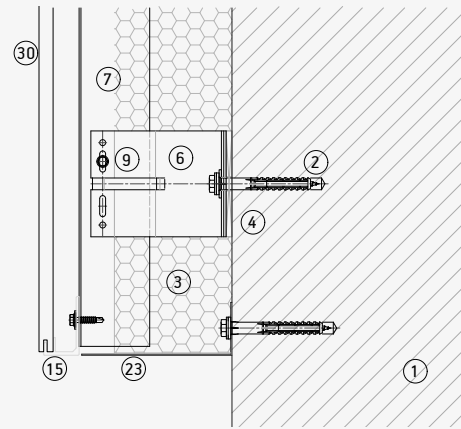

Horizontal joint

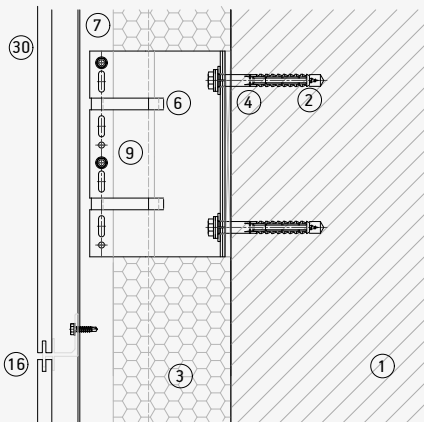

Joint between profiles

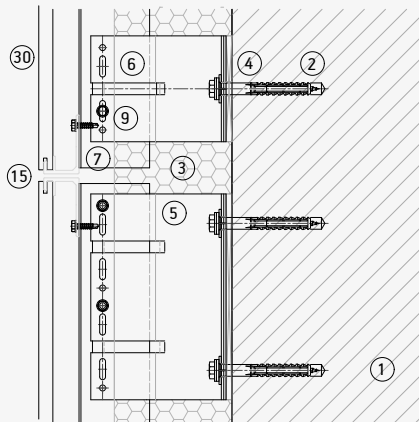

- 1. Supporting wall.
- 2. Anchor bracket.
- 3. Insulation.
- 4. Insulating layer.
- 5. Fixed bracket.
- 6. Adjustable bracket.
- 7. L profile.
- 8. T profile.
- 9. Self tapping screw.

- 10. Rivet.
- 11. Undercut anchor.
- 12. Horizontal rail.
- 13. C hanger.
- 14. Adjustable C hanger.
- 15. Bottom/top edge profile/clip.
- 16. Intermediate edge profile/clip.

- 17. Bottom/top visible clip.
- 18. Intermediate visible clip.
- 19. Interior back clip
- 20. Exterior back profile
- 21. Chemical fixing system
- 22. Security fixing
- 23. Ventilation profile
- 24. Lintel
- 25. Jamb

- 26. Window sill
- 27. Top coping
- 28. Corner profile
- 29. Bonding adhesive
- 30. Dekton

DKT3 Vertical section

Dekton jamb

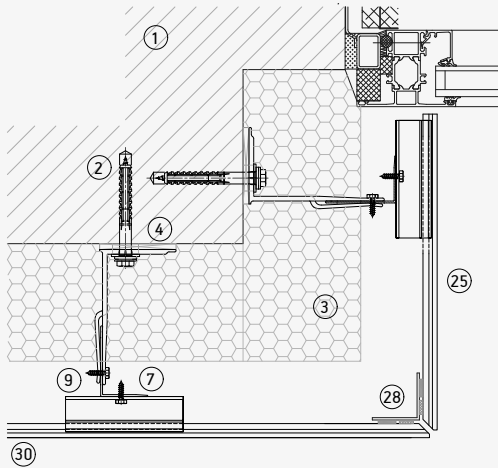

Metallic jamb

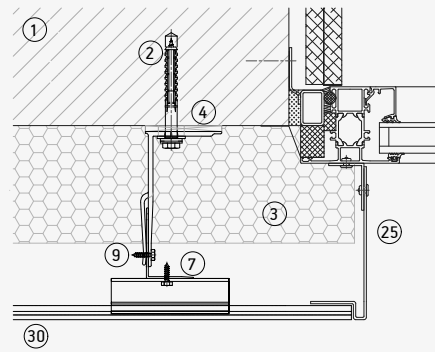

Metallic window sill

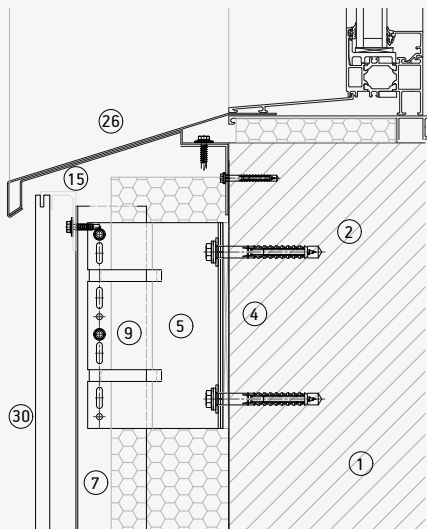

Dekton lintel

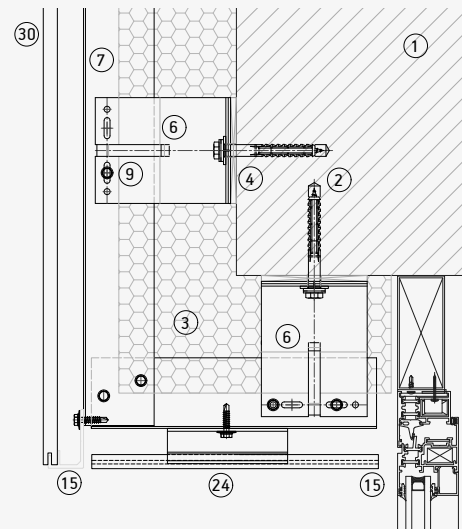

- | | | | |
|------------------------|-------------------------------------|--------------------------------|----------------------|
| 1. Supporting wall. | 10. Rivet. | 17. Bottom/top visible clip. | 26. Window sill |
| 2. Anchor bracket. | 11. Undercut anchor. | 18. Intermediate visible clip. | 27. Top coping |
| 3. Insulation. | 12. Horizontal rail. | 19. Interior back clip | 28. Corner profile |
| 4. Insulating layer. | 13. C hanger. | 20. Exterior back profile | 29. Bonding adhesive |
| 5. Fixed bracket. | 14. Adjustable C hanger. | 21. Chemical fixing system | 30. Dekton |
| 6. Adjustable bracket. | 15. Bottom/top edge profile/clip. | 22. Security fixing | |
| 7. L profile. | 16. Intermediate edge profile/clip. | 23. Ventilation profile | |
| 8. T profile. | | 24. Lintel | |
| 9. Self tapping screw. | | 25. Jamb | |

DKT3 System

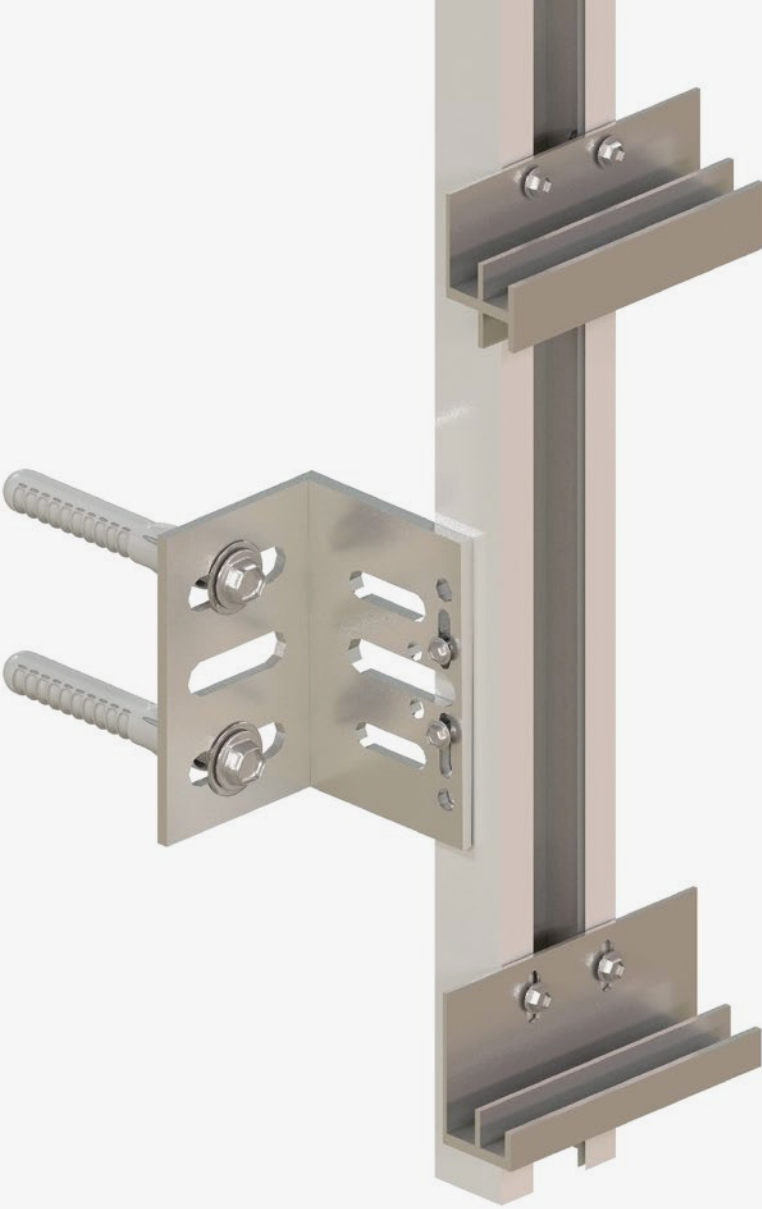

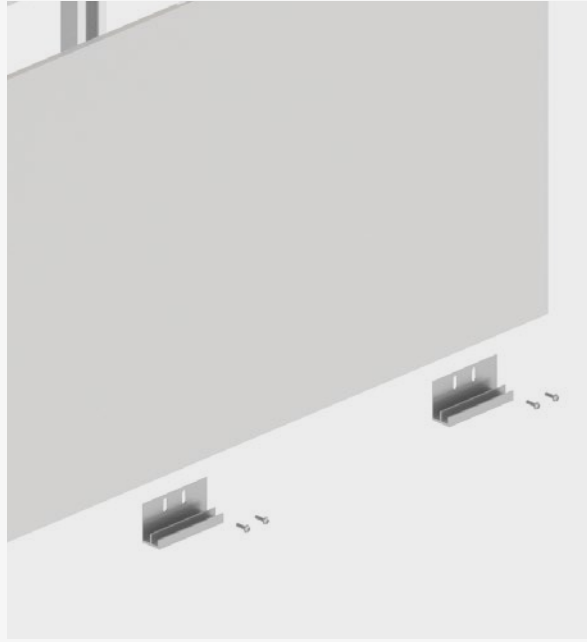
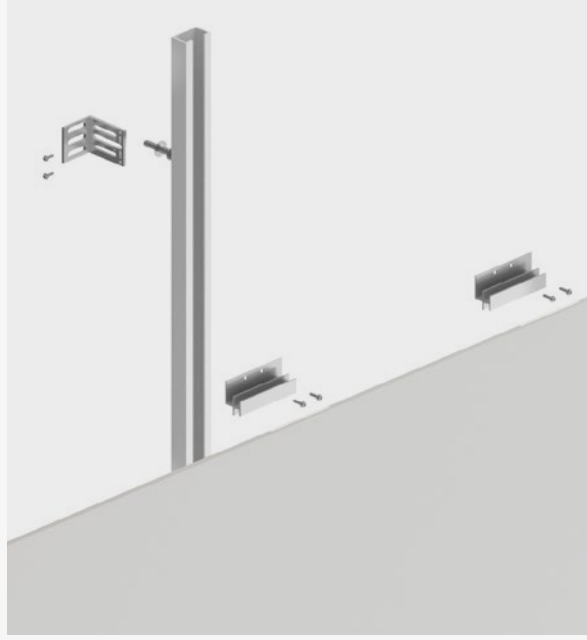
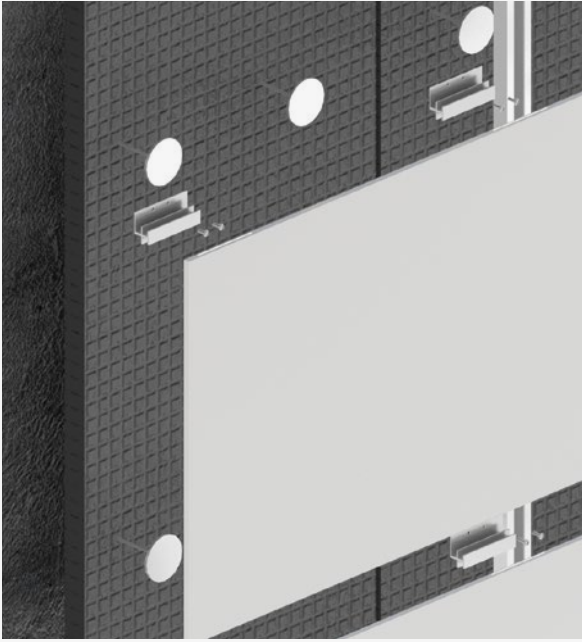
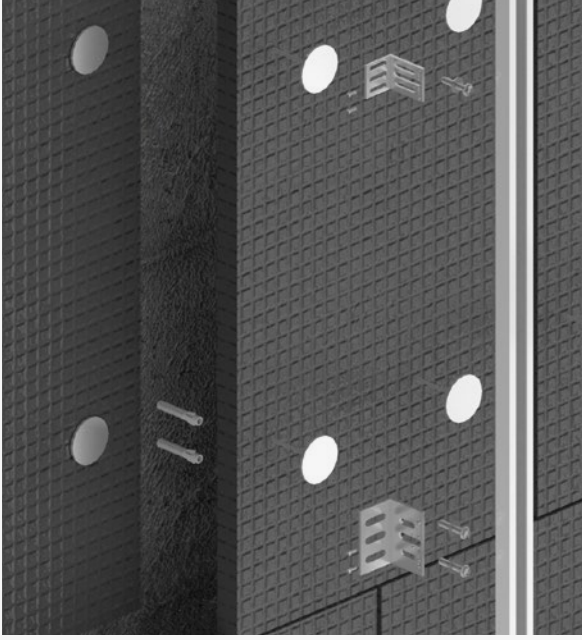

DKT3 Static Calculations

Schemes and data to be defined with SDP software

Panels in horizontal or vertical layout. Maximum wind loads shown in the following configurations depend on the grid spacing and distance from drill holes to the edges.

These configurations have been calculated considering a distance of fixing to edges of 200mm. For further distances and configurations please consult with our Technical Department.

The tables and diagrams presented are based on Dekton calculation software and refer only to Dekton. They cannot be considered as definitive data for on-site installation and it is necessary for a qualified technician

to make a specific project calculation for the entire façade system including support anchors, brackets, profiles, screws and Dekton fixing elements to the façade

How to use the reference configurations:

- Determine the design wind load kN/m^2 .
- Choose the table according to the fixing system and Dekton thickness.
- Select the closest design wind load. The wind load chosen should not be less than actual requirements.
- Select a reference configuration showing maximum spacing between fixings.

DKT3

Dekton 12mm

Complete configuration table

Design wind load kN/m^2	Horizontal	Spacing between top/ bottom clips (mm)	Spacing between clips (mm)
2	H1	1440	450

Dekton 20mm

Complete configuration table

Design wind load kN/m^2	Horizontal	Spacing between top/ bottom clips (mm)	Spacing between clips (mm)
2.8	H1	1440	450

DKT3 Layout

Design wind loads to be compared with reference design wind loads provided in this document should have applied wind load factors on characteristic values per applicable standards and regulations.

Design wind loads and fixing distances should be calculated per local standards, regulations and certificates applicable, with further testing if required.

Cosentino does not provide static calculations for projects.

Cosentino will not accept any liability whatsoever for any direct or indirect damage resulting from any errors, omissions or miscalculations of the static calculations for the project.

12mm HORIZONTAL CONFIGURATION

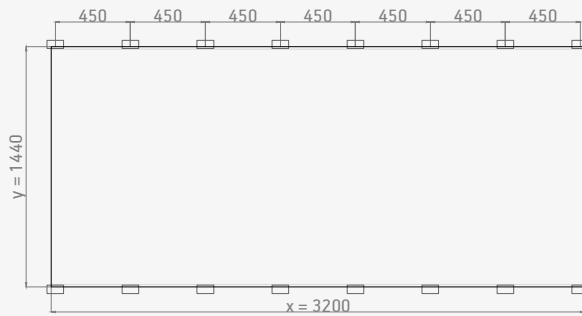

H1. Max. Design wind load: 2.0 kN/m^2

20mm HORIZONTAL CONFIGURATION

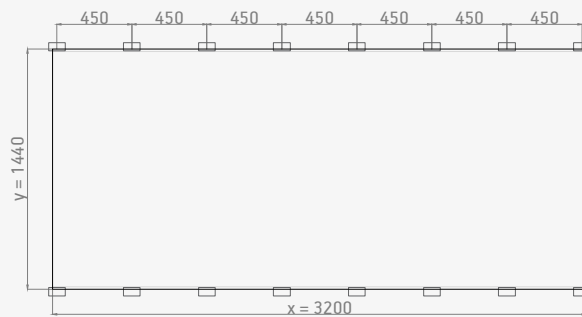

H1. Max. Design wind load: 2.8 kN/m^2

CASE STUDY

Tabacalera Apartment Building

A Coruña, Spain

Material

Dekton® Sirius

Facade system

DKT3

Thickness

12mm







DK T4

Visible Clip Fixing System

In the DKT4 system of visible fixing, the piece is shown as it is, with the fixing tabs of the upper and lower pieces visible to the eye. The clips hold both pieces and keep them in line with the plane of the façade, as well as maintaining the distances (joints) between consecutive pieces.

Although this type of fixing is fairly flexible in adapting to the thickness of the material, it is ideal for the smaller sizes, lighter weights and smaller thicknesses.



Mechanical fixing
using visible clips
that hold the pieces.

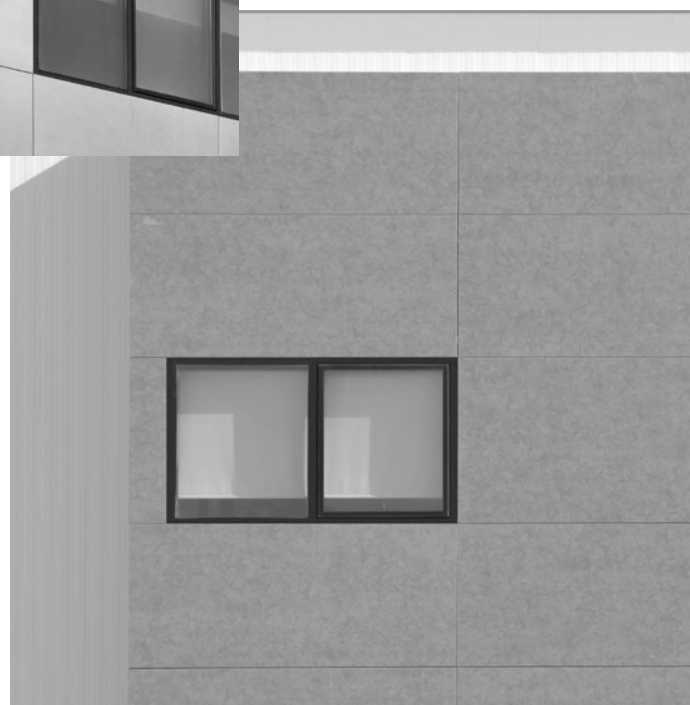

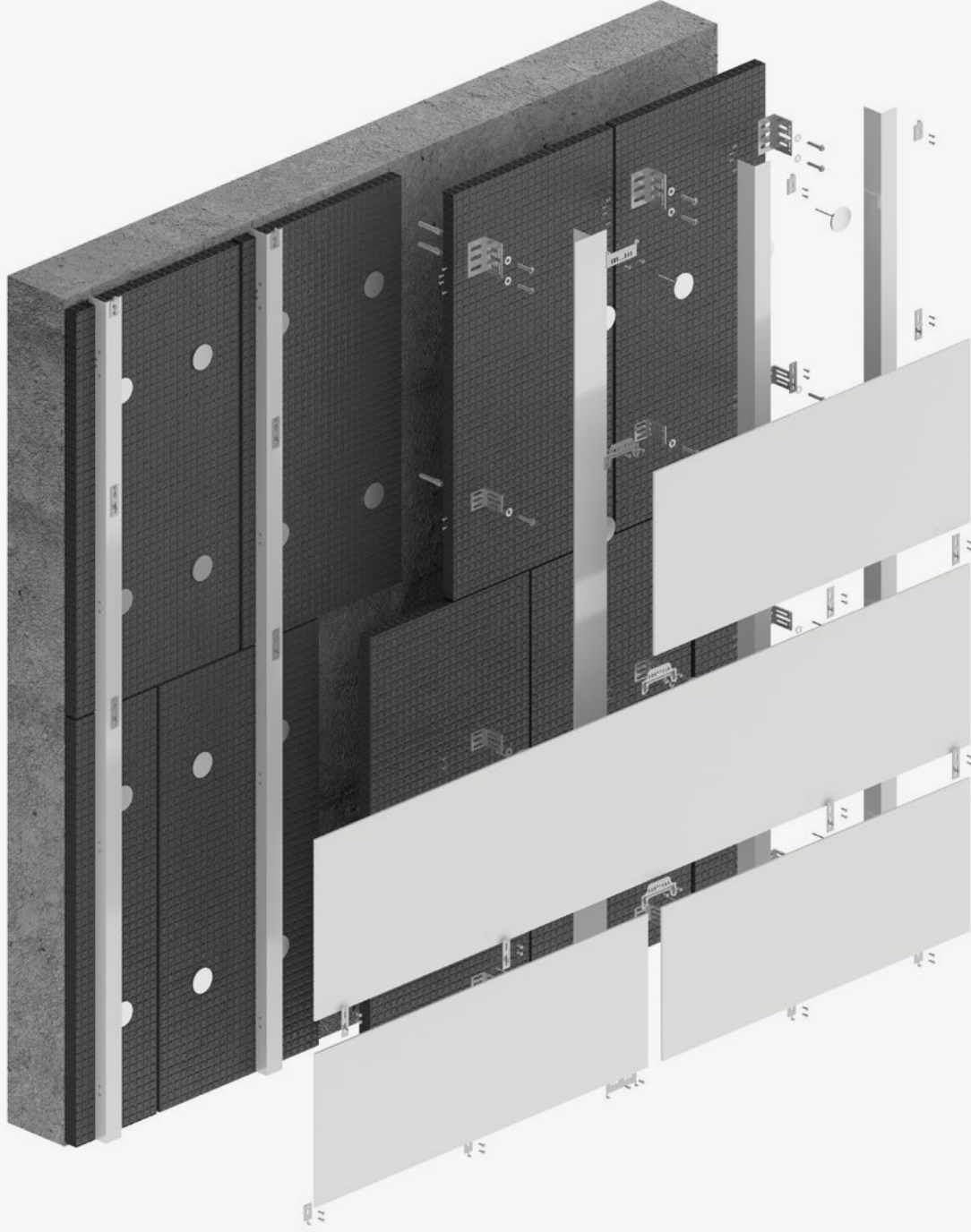

DKT4 - Diagram

Bottom and middle clips



Middle clips

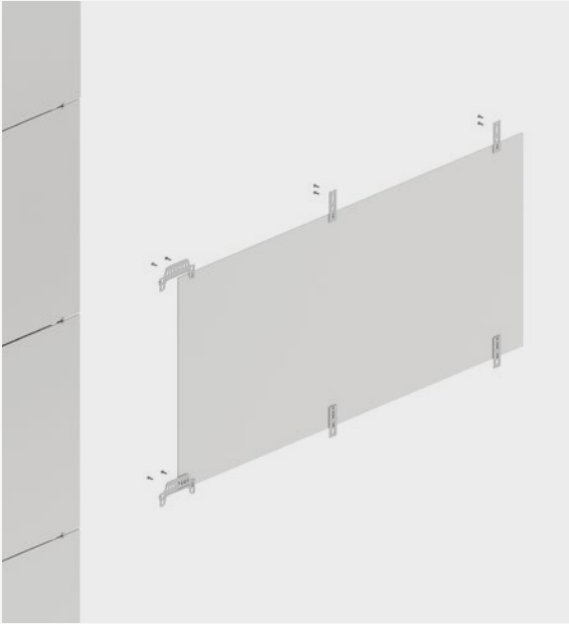

Joints

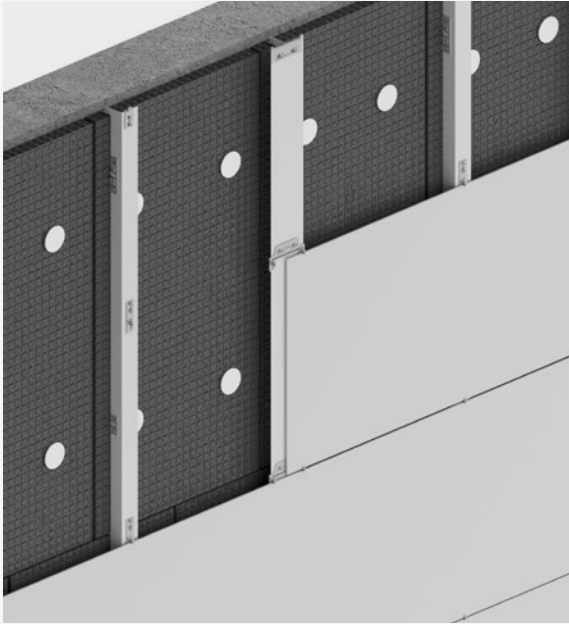

Bottom clips

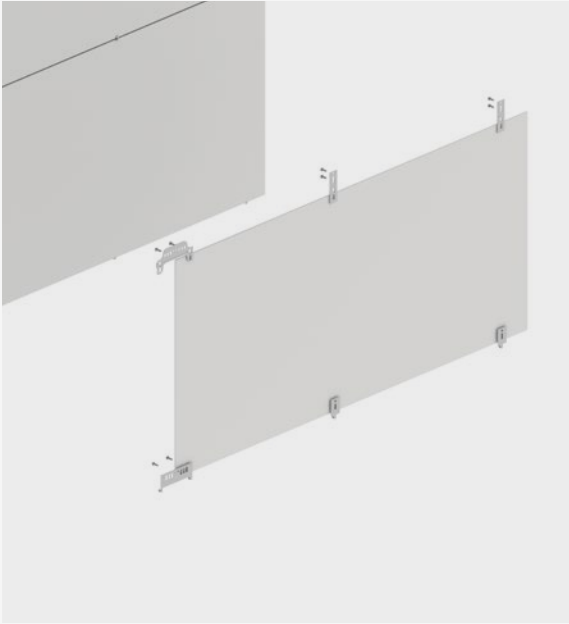

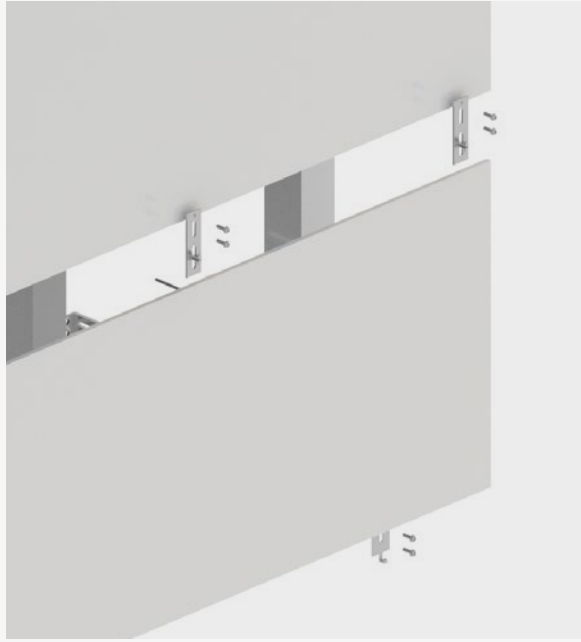
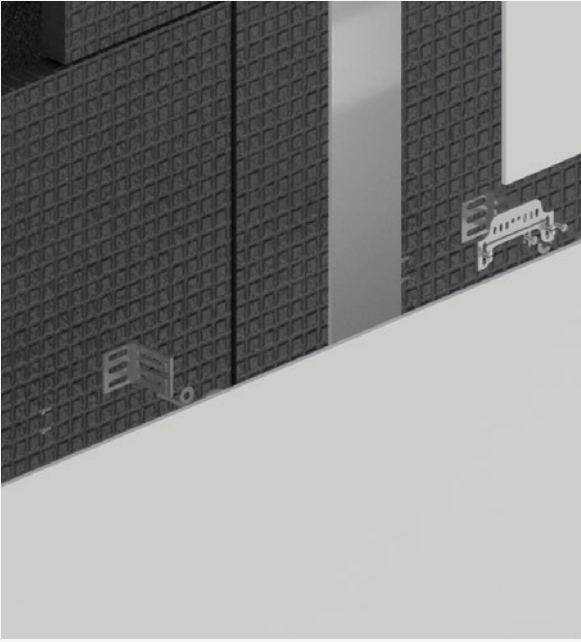
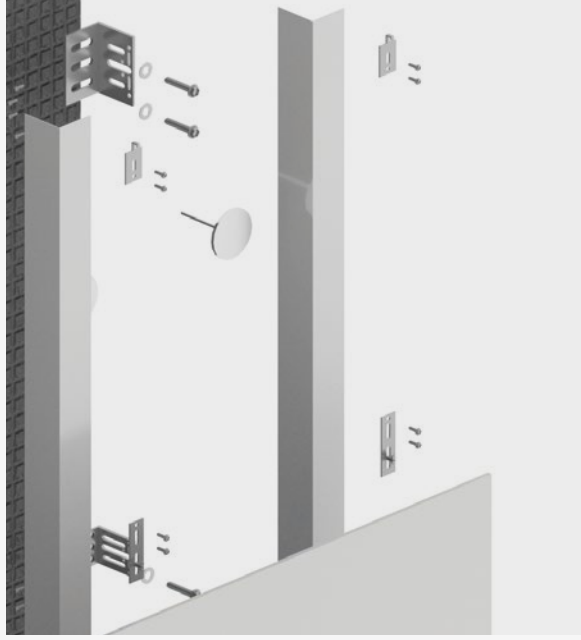
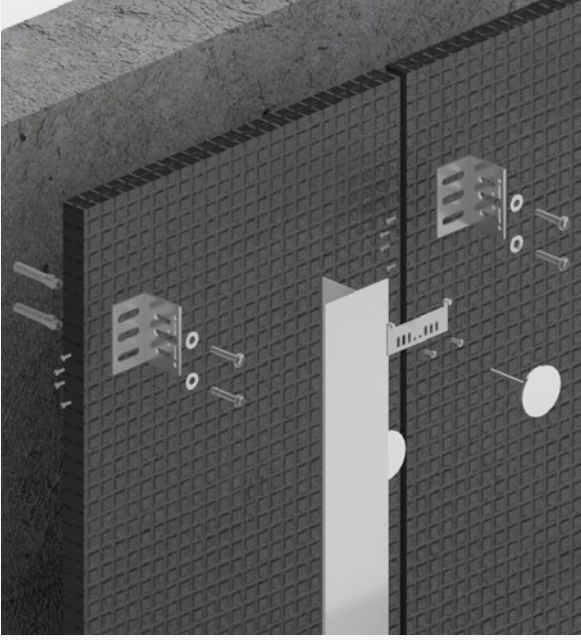

DKT4 System Description

Visible system

Supporting substructure made up of; metal brackets, adjustable to correct unevenness and compatible with different types of supports, can include thermal break insulators; vertical metal profiles of different sections according to the required application; horizontal metal profiles or H-Carrier/Rail or J-Carrier/Rail type clips; visible anchoring system by means of continuous grooving in the Dekton® panel for fixing by insertion.

Installation process

Brackets installed on the surface to be covered by means of a mechanical system or welding; vertical profiles installed on brackets with a system of regulation and fixing, by means of specific screws*; visible accessory of the H-Carrier/Rail or J-Carrier/Rail type with a system of regulation and fixing, installed by means of specific screws* on the vertical profiles; Installation of the lower edge of the Dekton® panel on a visible accessory such as the H-Carrier/Rail or J-Carrier/Rail clip; installation of the lock on the upper part, visible accessory such as the H-Carrier/Rail or J-Carrier/Rail clip.

*Specific screws according to the structural calculation of each project or indicated by the supplier of the substructure.



DKT4 Structure

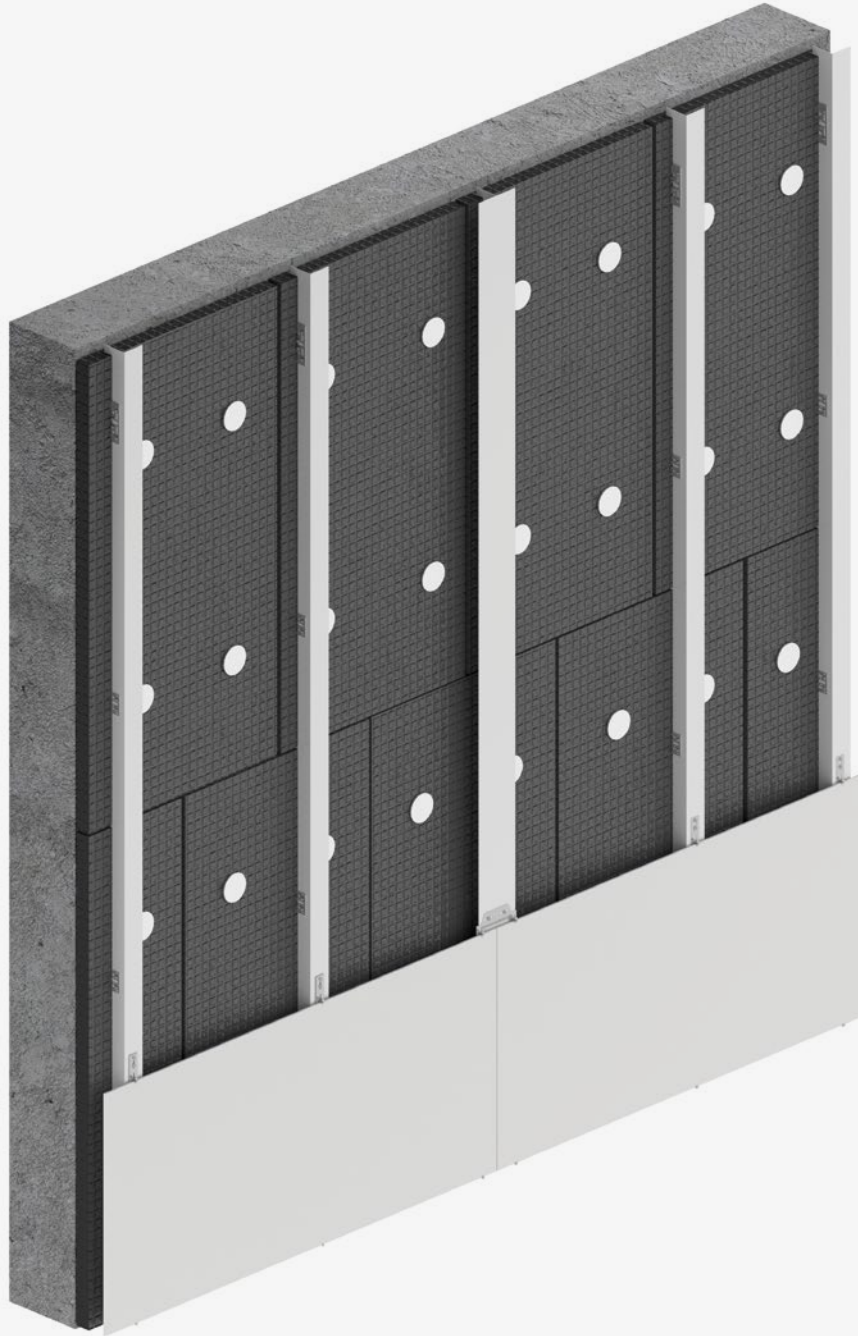

General fixing instruction

1. Define the layout and position of the clips over the vertical substructure.
2. In some clip systems, a spring is installed into the vertical profiles before fixing the clips, in order to avoid looseness between the Dekton® piece and vertical profiles.
3. Screw the bottom clips to the vertical profiles.
4. Place the Dekton® piece with grooved edges laying on the clips, that will support the piece weight.
5. Place the intermediate clips, inserting the Dekton® pieces into the clip tabs and screw the clips to the vertical profiles.
6. Repeat the process by placing another piece over the installed clips and fixing with upper clips.
7. Finish with the top pieces by installing a top-end clip with a slotted hole, by screwing them to the vertical profile, and fixing the piece into the clip tab by adjusting its position vertically.
8. Maximum cantilever distance of horizontal rails must be defined by system supplier.

Installation sequence from one side to another and from bottom to top

Fig. 1



Fig. 2

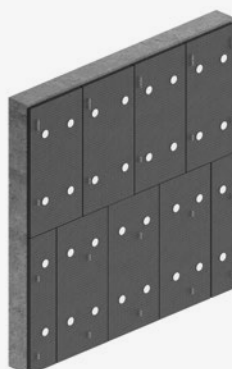

Fig. 3



Fig. 4

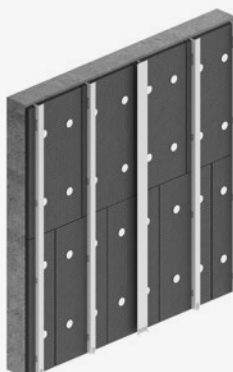

Fig. 5

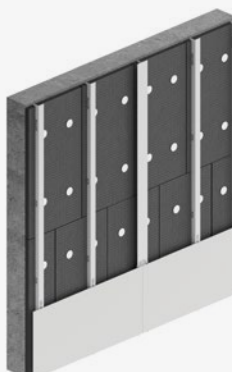
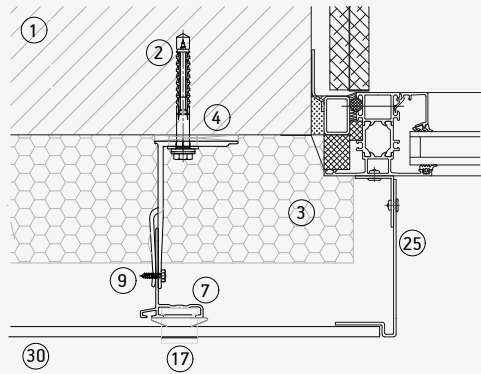

Fig. 6



DKT4 Horizontal section

Metallic jamb



Internal Corner

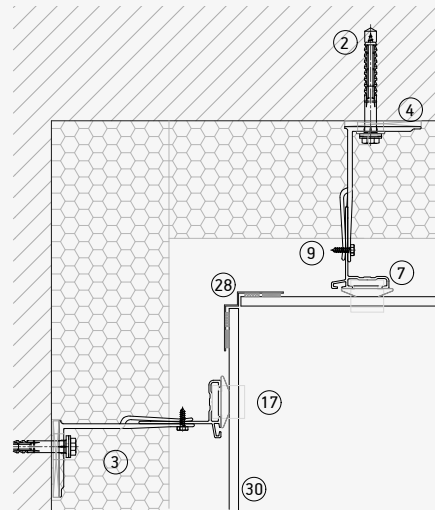

Dekton jamb

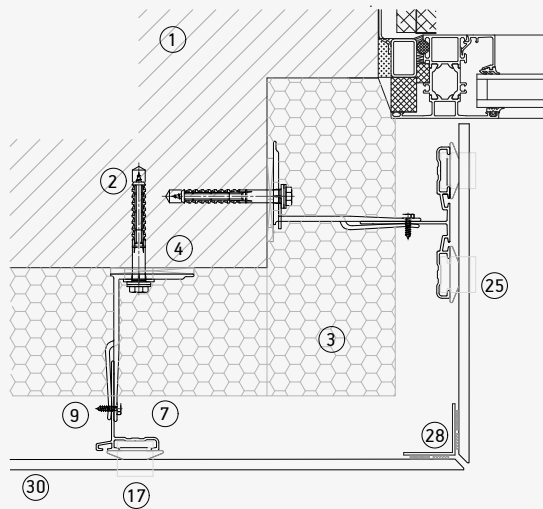

Vertical expansion joint

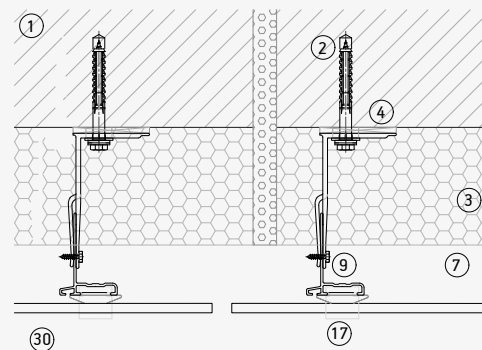

- | | | | |
|------------------------|-------------------------------------|--------------------------------|----------------------|
| 1. Supporting wall. | 10. Rivet. | 17. Bottom/top visible clip. | 26. Window sill |
| 2. Anchor bracket. | 11. Undercut anchor. | 18. Intermediate visible clip. | 27. Top coping |
| 3. Insulation. | 12. Horizontal rail. | 19. Interior back clip | 28. Corner profile |
| 4. Insulating layer. | 13. C hanger. | 20. Exterior back profile | 29. Bonding adhesive |
| 5. Fixed bracket. | 14. Adjustable C hanger. | 21. Chemical fixing system | 30. Dekton |
| 6. Adjustable bracket. | 15. Bottom/top edge profile/clip. | 22. Security fixing | |
| 7. L profile. | 16. Intermediate edge profile/clip. | 23. Ventilation profile | |
| 8. T profile. | | 24. Lintel | |
| 9. Self tapping screw. | | 25. Jamb | |

DKT4 Vertical section

Upper detail

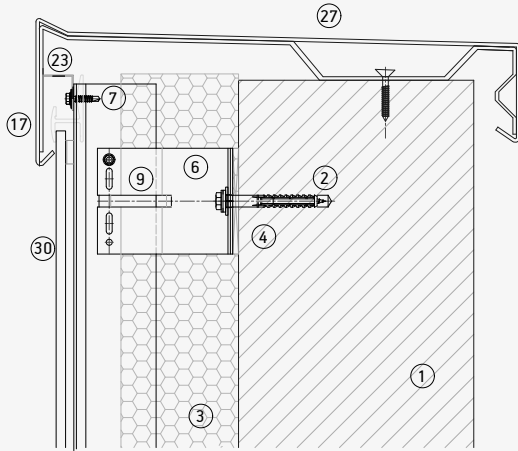

Bottom detail

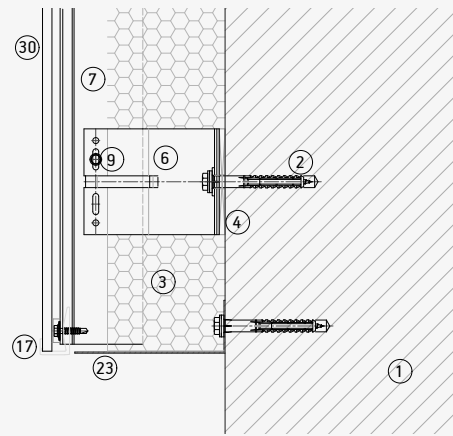

Horizontal joint

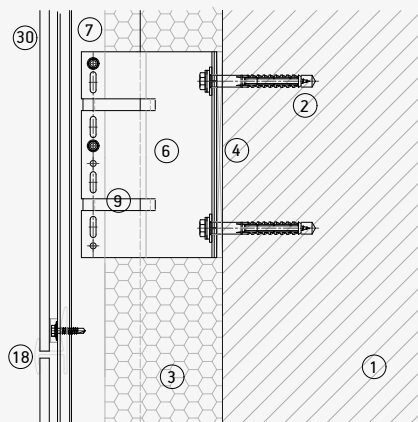

Joint between profiles

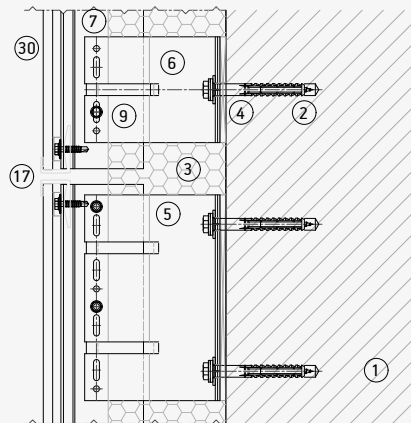

- | | | | |
|------------------------|-------------------------------------|--------------------------------|----------------------|
| 1. Supporting wall. | 10. Rivet. | 17. Bottom/top visible clip. | 26. Window sill |
| 2. Anchor bracket. | 11. Undercut anchor. | 18. Intermediate visible clip. | 27. Top coping |
| 3. Insulation. | 12. Horizontal rail. | 19. Interior back clip | 28. Corner profile |
| 4. Insulating layer. | 13. C hanger. | 20. Exterior back profile | 29. Bonding adhesive |
| 5. Fixed bracket. | 14. Adjustable C hanger. | 21. Chemical fixing system | 30. Dekton |
| 6. Adjustable bracket. | 15. Bottom/top edge profile/clip. | 22. Security fixing | |
| 7. L profile. | 16. Intermediate edge profile/clip. | 23. Ventilation profile | |
| 8. T profile. | | 24. Lintel | |
| 9. Self tapping screw. | | 25. Jamb | |



CASE STUDY

Schaffhauserstrasse

Zurich, Switzerland

Material

550m² Dekton® Sirius

Installation system

DKT4

Thickness

20mm





Mechanical or Mechanical-Chemical Systems with Double Back Grooving

DKBG is a mechanical or hybrid fixing system (mechanical with chemical reinforcement).

The type of mechanical anchorage is made up of a series of clips of variable length with two inclined flanges that are fixed to the discontinuous grooves of greater or lesser length made in

the rear face of the piece, and later they are fitted and fixed within a rail horizontal with hook function.

In this type of hybrid system, two hanger profiles (upper and lower) are chemically and mechanically anchored to the material by means of adhesive and an inclined or straight grooving with greater

or lesser travel on the rear face of the piece, forming a metal hook.

In both types of systems, the profiles with support rail function that are assembled to the uprights of the substructure ensure the stability of the fixing under heavy loads.

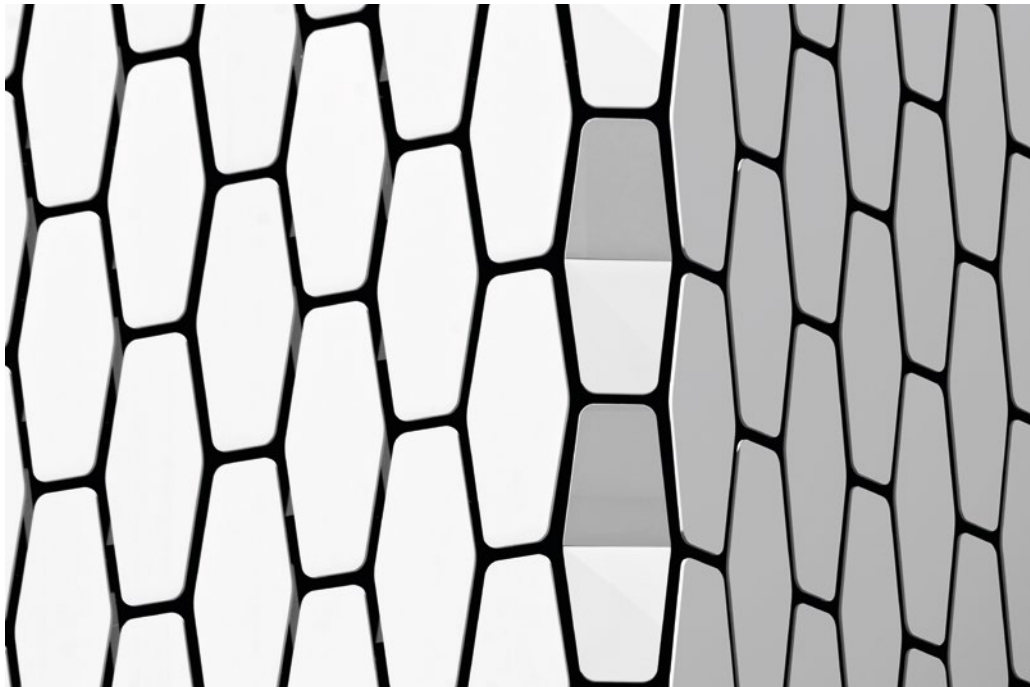

Mechanical or hybrid (mechanical + chemical) fixation with dovetail-shaped grooves on the back of the pieces.

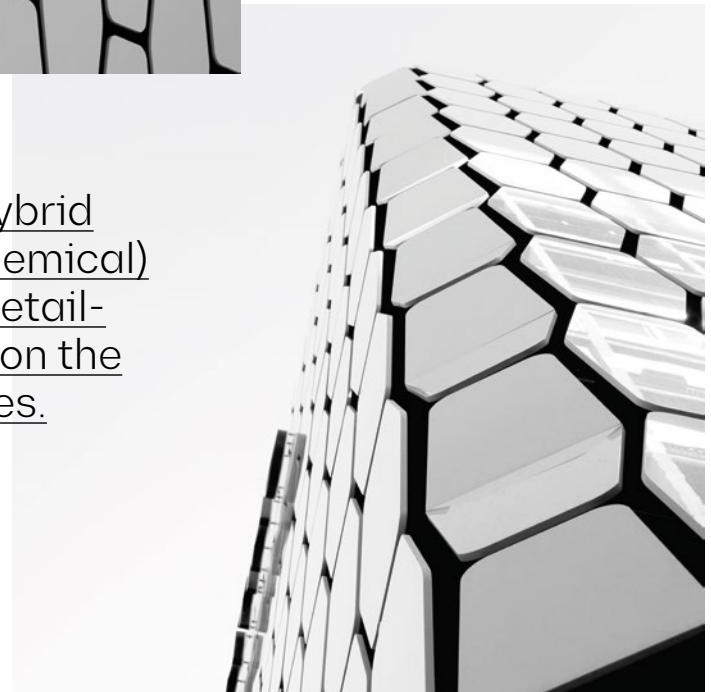

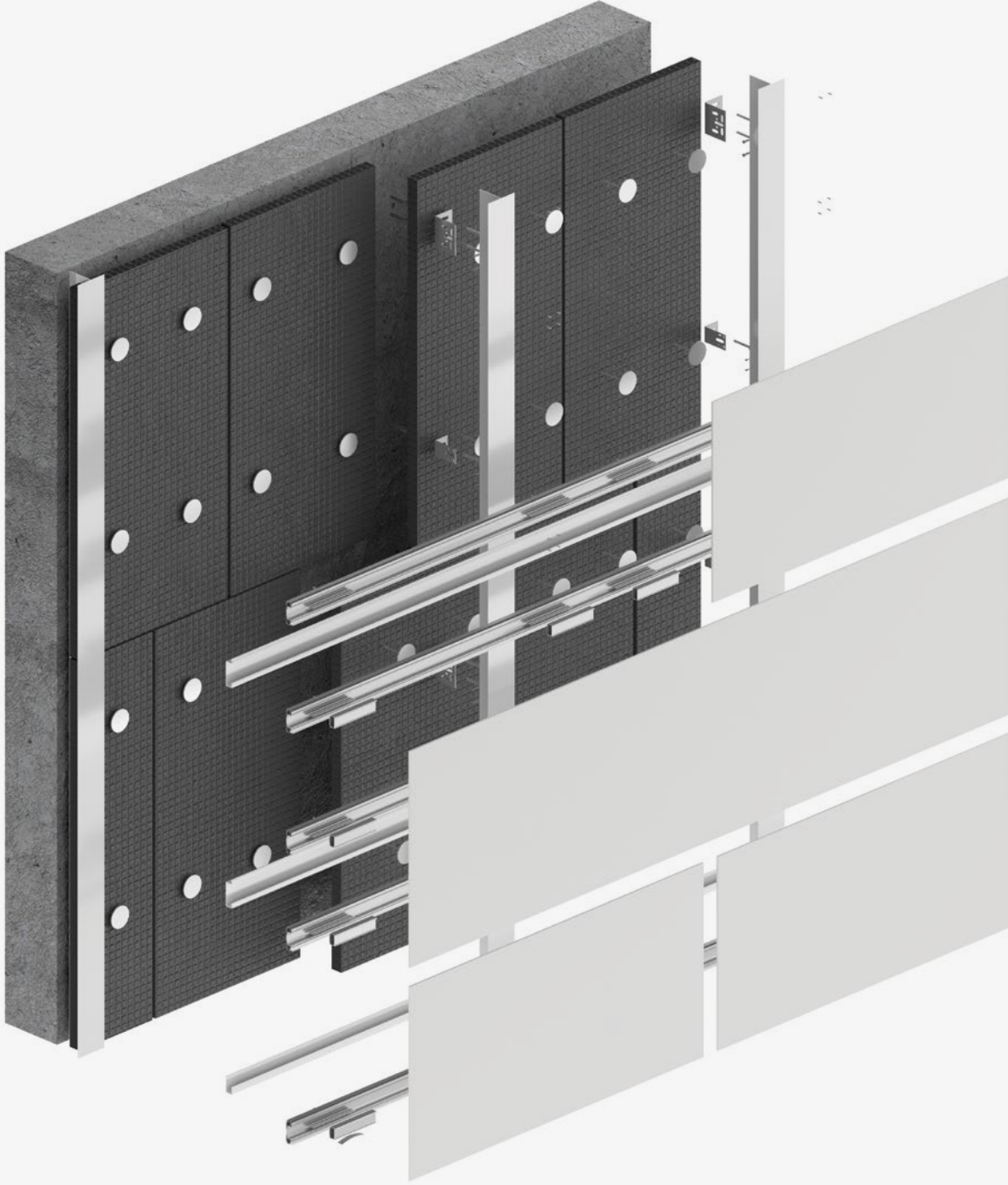

Substructure



Back view



Profiles detail

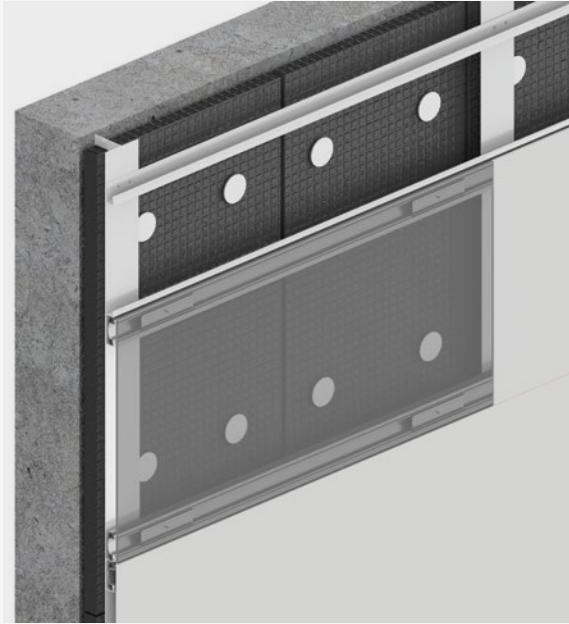

System detail

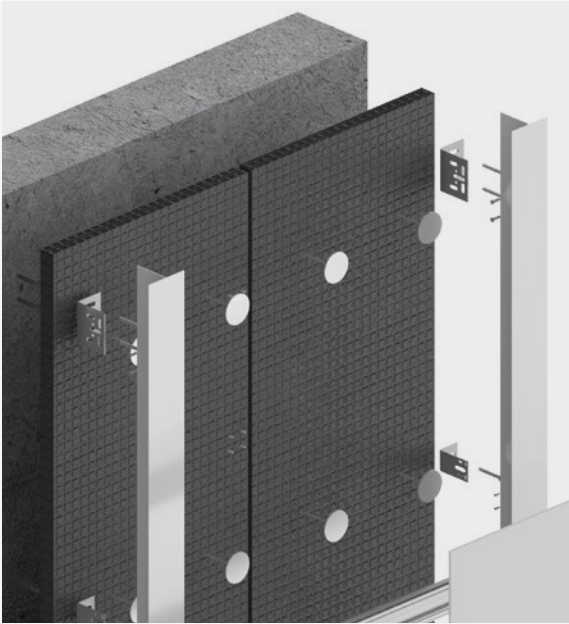

DKBG Structure



Secondary structure and fixing instructions

1. Define the layout and position of the horizontal carriers over the vertical substructure.
2. Level and fix the horizontal carrier profiles to the vertical profiles.
3. Only for mechanical systems:
 - Insert the clips into the discontinuous double grooves in dovetail shape previously machined on the back of the Dekton® pieces, by opening slightly the clip tabs and fitting them into the grooves. Once fixed, the clips should not be loose.
4. For hybrid systems: Glue the two aluminum profiles with adhesive to the continuous double back grooves in dovetail shape on the back of the Dekton® pieces, to conform the hanging system.
5. Hang the piece vertically into the horizontal carrier profiles.
6. Insert spacer clips on edges for vertical joints alignment if necessary and place the next piece; repeat the process installing from the bottom to the top of the façade.
7. Maximum cantilever distance of horizontal rails must be defined by the system supplier.

Installation sequence from one side to another and from bottom to top

Fig. 1

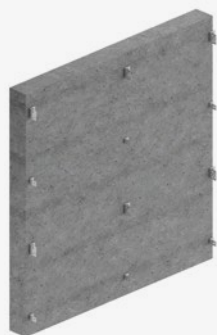

Fig. 2

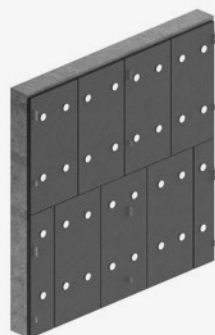

Fig. 3



Fig. 4



Fig. 5



Fig. 6



DKBG System Description

Hidden system

Supporting substructure made up of; metal brackets, adjustable to correct unevenness and compatible with different types of supports, can include thermal break insulators; vertical metal profiles of different sections according to the application required; continuous horizontal U-Carrier/Rail type metal profiles; hidden anchoring system by means of a specific compression clip inserted into a groove in the back of the Dekton panel; continuous profile to block the grip clip on the Dekton panel.

Installation process

Brackets installed on the surface to be covered by means of a mechanical or welding system; vertical profiles installed on brackets with a regulation and fixing system, by means of specific screws*; continuous horizontal U-Carrier/Rail profiles with a regulation and fixing system, installed by means of specific screws* on vertical profiles; clip-type accessory after joining with a blocker on the back of the Dekton surface, installed on U-Carrier/Rail with a regulation and fixing system.

*Specific screws according to the structural calculation of each project or indicated by the supplier of the substructure.



DKBG Horizontal section

Mitered external corner

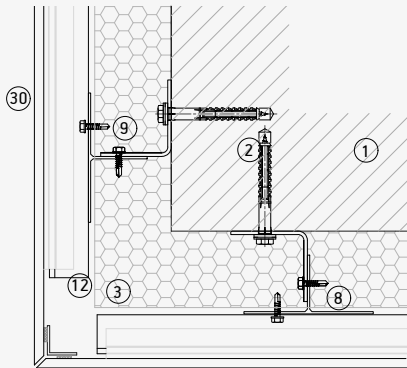

Internal Corner

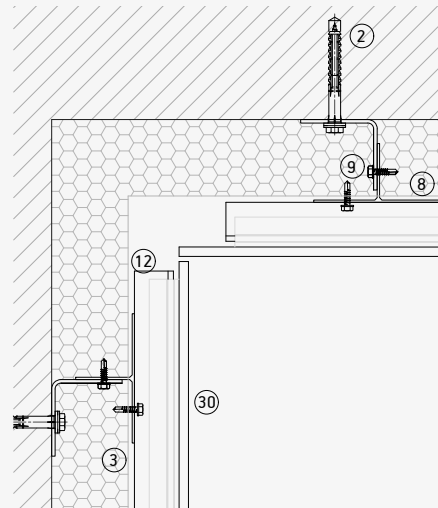

Vertical joint

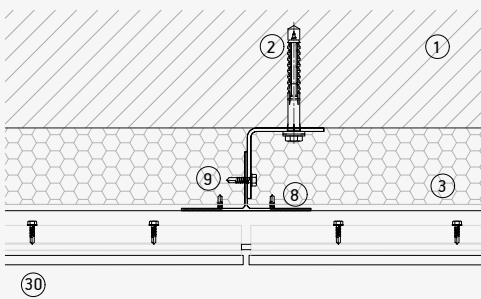

Vertical expansion joint

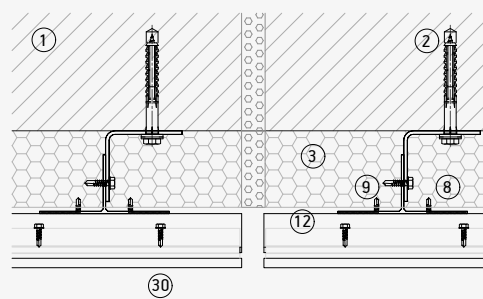

- | | | | |
|------------------------|-------------------------------------|--------------------------------|----------------------|
| 1. Supporting wall. | 10. Rivet. | 17. Bottom/top visible clip. | 26. Window sill |
| 2. Anchor bracket. | 11. Undercut anchor. | 18. Intermediate visible clip. | 27. Top coping |
| 3. Insulation. | 12. Horizontal rail. | 19. Interior back clip | 28. Corner profile |
| 4. Insulating layer. | 13. C hanger. | 20. Exterior back profile | 29. Bonding adhesive |
| 5. Fixed bracket. | 14. Adjustable C hanger. | 21. Chemical fixing system | 30. Dekton |
| 6. Adjustable bracket. | 15. Bottom/top edge profile/clip. | 22. Security fixing | |
| 7. L profile. | 16. Intermediate edge profile/clip. | 23. Ventilation profile | |
| 8. T profile. | | 24. Lintel | |
| 9. Self tapping screw. | | 25. Jamb | |

DKBG Vertical section

Upper detail

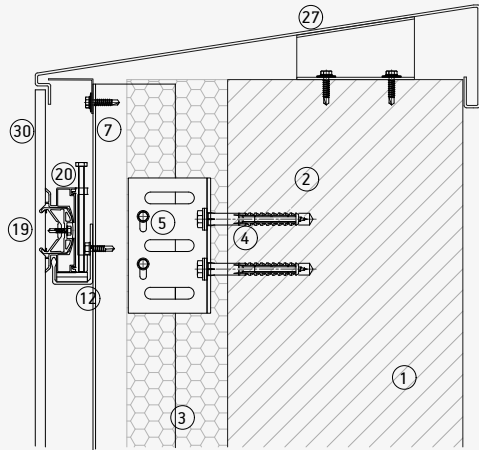

Bottom detail

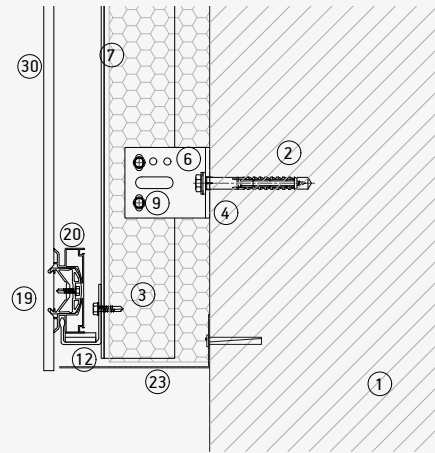

Horizontal joint

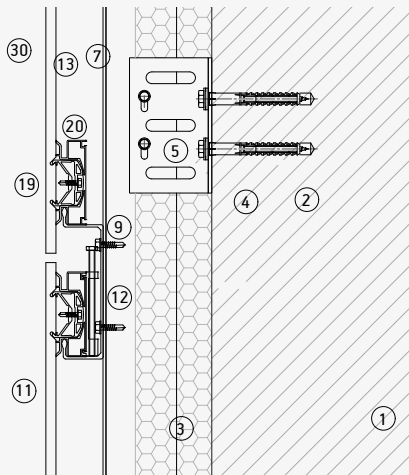

Joint between profiles

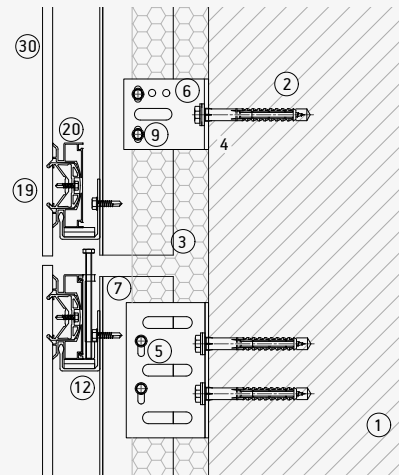

- 1. Supporting wall.
- 2. Anchor bracket.
- 3. Insulation.
- 4. Insulating layer.
- 5. Fixed bracket.
- 6. Adjustable bracket.
- 7. L profile.
- 8. T profile.
- 9. Self tapping screw.

- 10. Rivet.
- 11. Undercut anchor.
- 12. Horizontal rail.
- 13. C hanger.
- 14. Adjustable C hanger.
- 15. Bottom/top edge profile/clip.
- 16. Intermediate edge profile/clip.

- 17. Bottom/top visible clip.
- 18. Intermediate visible clip.
- 19. Interior back clip
- 20. Exterior back profile
- 21. Chemical fixing system
- 22. Security fixing
- 23. Ventilation profile
- 24. Lintel
- 25. Jamb

- 26. Window sill
- 27. Top coping
- 28. Corner profile
- 29. Bonding adhesive
- 30. Dekton

DKBG Vertical section

Dekton jamb

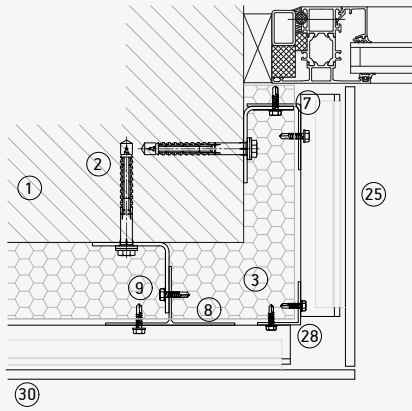

Metallic jamb

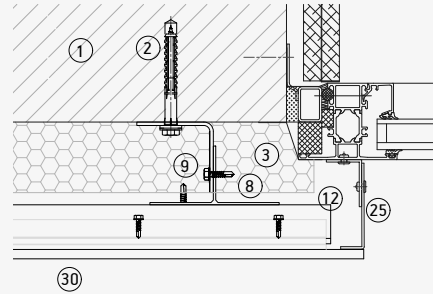

Metallic window sill

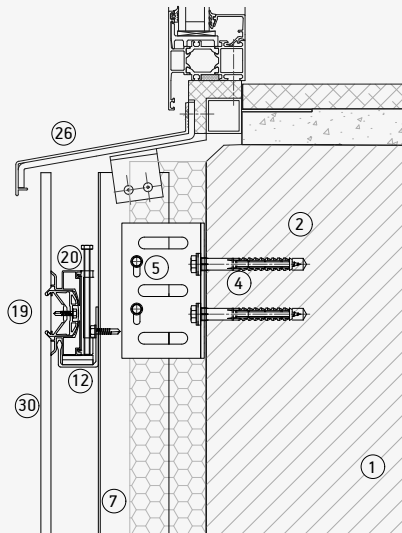

Dekton lintel

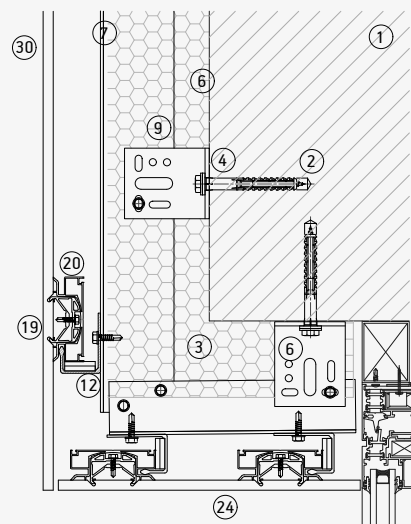

- | | | | |
|------------------------|-------------------------------------|--------------------------------|----------------------|
| 1. Supporting wall. | 10. Rivet. | 17. Bottom/top visible clip. | 26. Window sill |
| 2. Anchor bracket. | 11. Undercut anchor. | 18. Intermediate visible clip. | 27. Top coping |
| 3. Insulation. | 12. Horizontal rail. | 19. Interior back clip | 28. Corner profile |
| 4. Insulating layer. | 13. C hanger. | 20. Exterior back profile | 29. Bonding adhesive |
| 5. Fixed bracket. | 14. Adjustable C hanger. | 21. Chemical fixing system | 30. Dekton |
| 6. Adjustable bracket. | 15. Bottom/top edge profile/clip. | 22. Security fixing | |
| 7. L profile. | 16. Intermediate edge profile/clip. | 23. Ventilation profile | |
| 8. T profile. | | 24. Lintel | |
| 9. Self tapping screw. | | 25. Jamb | |

CASE STUDY

ToHa by Ron Arad and Avner Yashar

Tel Aviv, Israel

Material

28,000 m² of Strato and 6 Dekton iD colours

Facade system

DKBG

Thickness

12 and 20 mm

For the ToHa building project in Tel Aviv, Israel, over 28,000 m² of Dekton® by Cosentino has been used to clad the facade, flooring, lifts, ceilings and interior partitions.

Located in the centre of Tel Aviv at the junction of two shopping streets, the ToHa building reaches 29 storeys high. Its unique, faceted profile, inspired by the geometry of an iceberg, was designed by Ron Arad together with Avner Yashar's local team to house an office complex that includes a public garden, viewing point and restaurant.

Over 28,000 m² of Dekton® by Cosentino was used to clad the building's facade, flooring, elevators, ceilings and interior partitions. The pieces, formed by more than 10,000 different types, were manufactured and cut at Cosentino's headquarters in Cantoria (Almeria, Spain) and transported by ship to Israel.

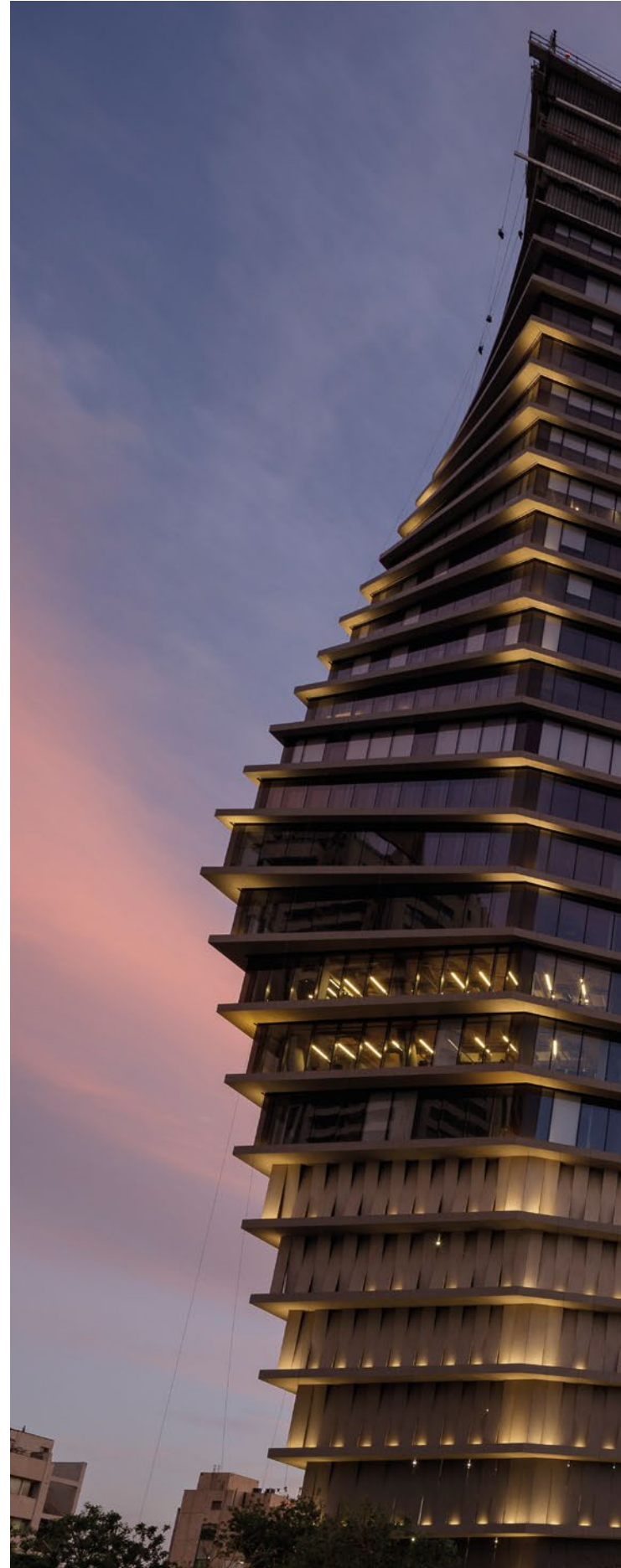



Architectural and decorative aspect of the project.

A key strategic focus of the project was to reduce the building's surface area at street level to create a large garden area, improving the quality of the surrounding area for the public. As a result, the building rises up on two huge legs that widen progressively, framing a spiralled profile. Geometrically versatile, Dekton® adapts with precision to the complexity of the building, thanks to its infinite range of formats, from minimal thickness to maximum surface areas.

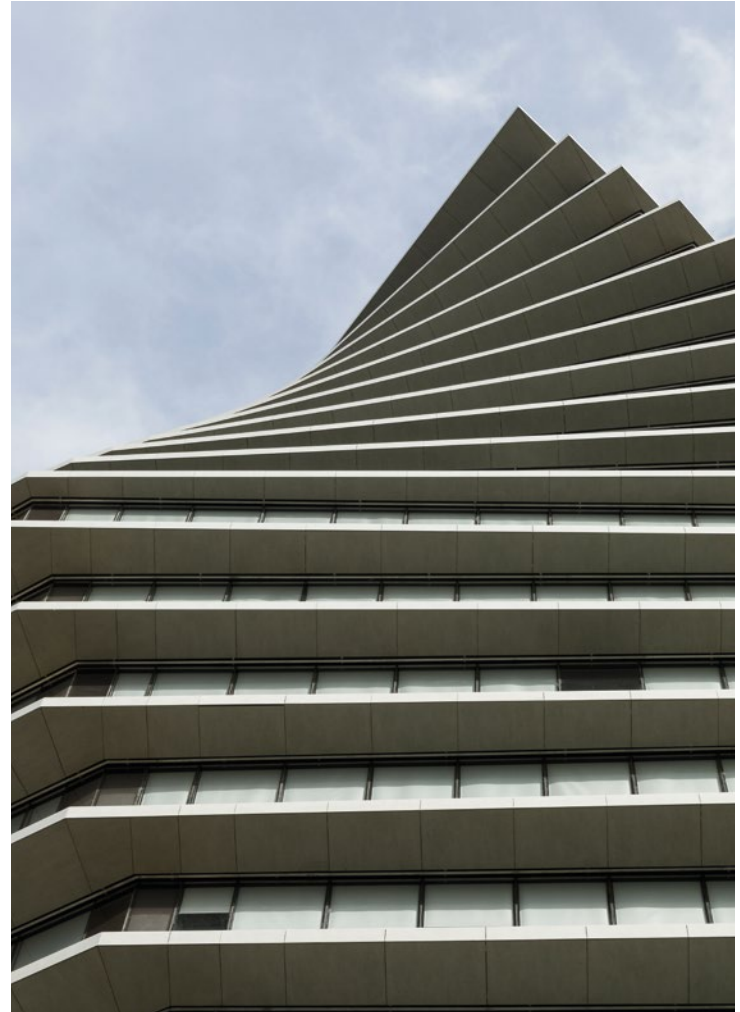

On the intermediate floors, the broken perimeter of the concrete slabs is clad with panels 12 millimetres thick and up to two metres wide which, thanks to minutely accurate cutting, define the vertexes and edges exactly to create an image of perfection.

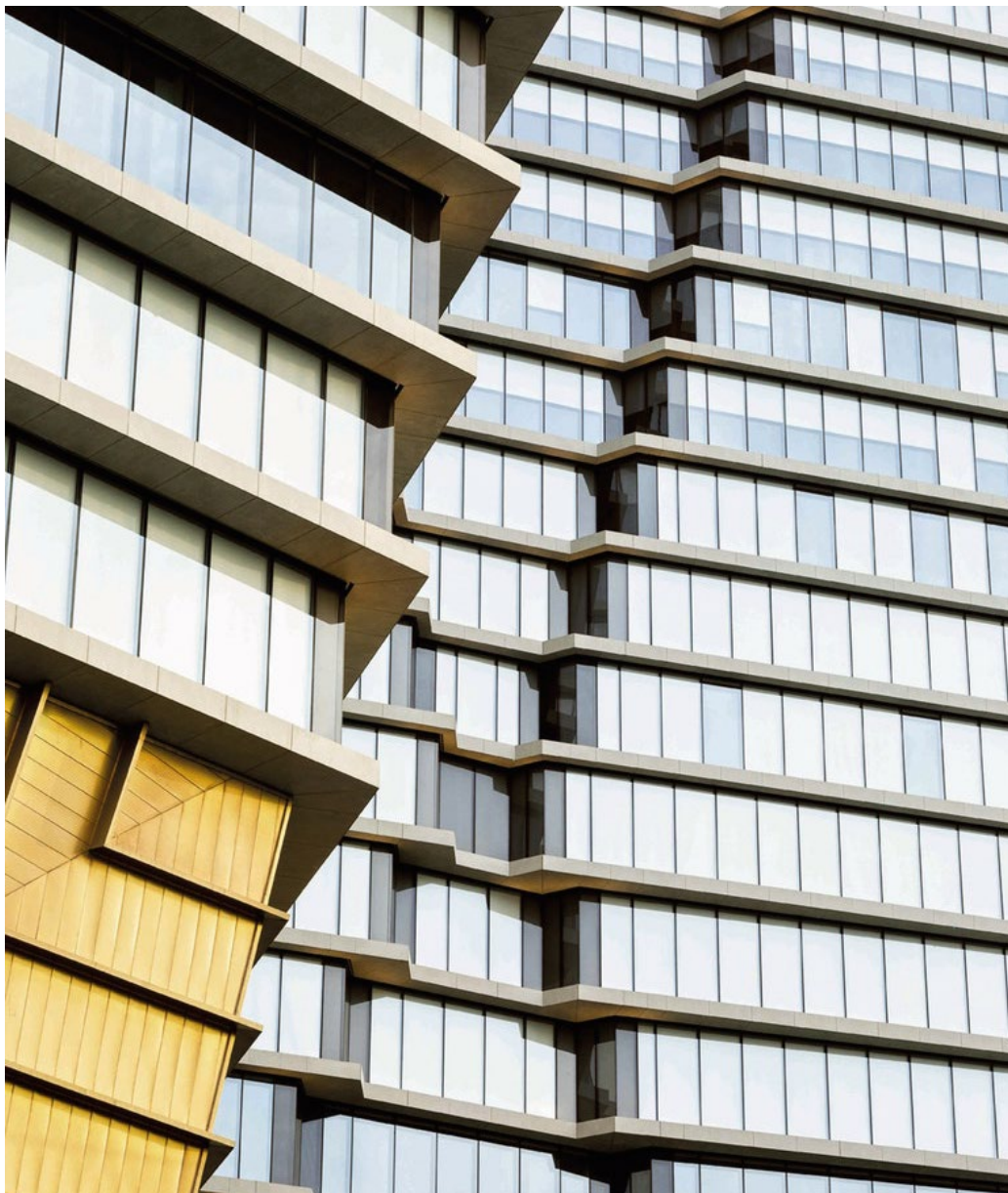

From a functional point of view, this ambitious project turns the traditional layout of an office block on its head, locating facilities on the ground floor to free up space at the top. This way, the upper levels can be dedicated to leisure use and the offices are distributed up from the seventh floor, optimising access to natural light and views.

The technical foundations are clad using a unique ventilated facade system that alternates the orientation of intersecting Dekton® panels.

This application allows for the passage of air between the large-format (320 x 70 cm) pieces and creates a uniform frontage that gives texture and depth to the elevation. Cosentino also offers the opportunity to custom-make a personalised palette of six colours, based on the Strato model, that create a progressive colour gradation from the lower part upwards.

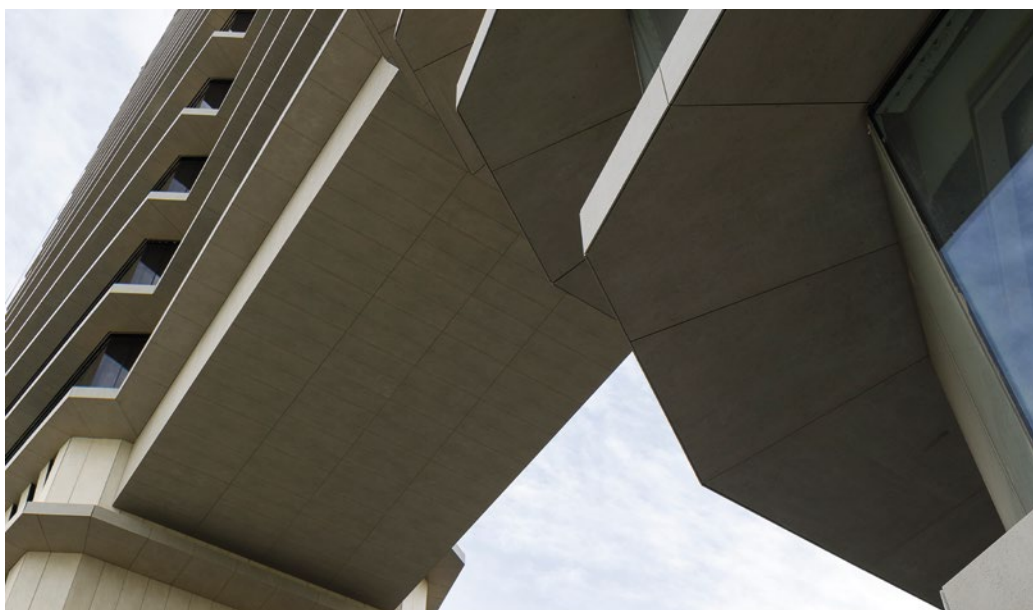



Inside, a huge 30-metre atrium acts as a vestibule and meeting point. The offices face outwards, through a glass facade, and inwards towards the central courtyard lit by a large light well.

Finishes have been carefully chosen to create a comfortable workplace and coherent corporate image. The possibility to produce large-format Dekton pieces for floors, walls and ceilings allows the number of joints to be reduced and the sense of continuity to be maximised.





Project details

Name: ToHa

Location: Tel Aviv, Israel

End date: 2019

Architecture: Arad Architects, Yashar Architects

Collaborators: Buro Happold Engineering, Israel David Engineering (Consultant structural engineer)

Client: Gav-Yam Amot Totseret Ha-Aretz

Cosentino materials

Application: Roof

Material: Dekton® by Cosentino

Colour Strato

Thickness: 4mm

Quantity: 1,800 m²

Format: 140x30

Application: Flooring

Material: Dekton® by Cosentino

Colour: Soke, Sirius, Strato

Thickness: 8 and 20 mm

Quantity: 3,500 m²

Format: Various: 320x144, 140x80, 80x170

Application: interior walls/facade

Material: Dekton® by Cosentino

Colour: Zenith, Sirius, Kadum, Spectra, Strato

Thickness: 8mm

Quantity: 2,000 m²

Format: Various: 80x270, 70x300

Application: Ventilated facade

Material: Dekton® by Cosentino

Colour: Strato, Spectra

Customised colours: Totzeret1, Totzeret2, Totzeret3, Totzeret4, Totzeret5, Totzeret6

Thickness: 12mm

Quantity: 20,000 m²

Format: various

Photography credits: Fernando Alda

CASE STUDY

Rafa Nadal Academy by Movistar

Manacor, Majorca, Spain

Material

Dekton® Strato, Ventus, Zenith, Spectra, Trilium,
Keon, Domoos and Customised Blue.

Facade system

DKBG

Thickness

8, 12 and 20 mm









CASE STUDY

Armonk Professional Center

New York City, USA

Material

126m² Dekton® Trilium

Facade system

DKBG

Thickness

12mm

CASE STUDY

Gunni & Trentino Flagship Store

Madrid, Spain

Material

600m² Dekton® Xgloss Halo
100m² Dekton® Domoos

Facade system

DKBG

Thickness

12mm







CASE STUDY

Cajamar Building

Almería, Spain

Material

2,000 m² Dekton® Sirocco

Facade system

DKBG

Thickness

12mm

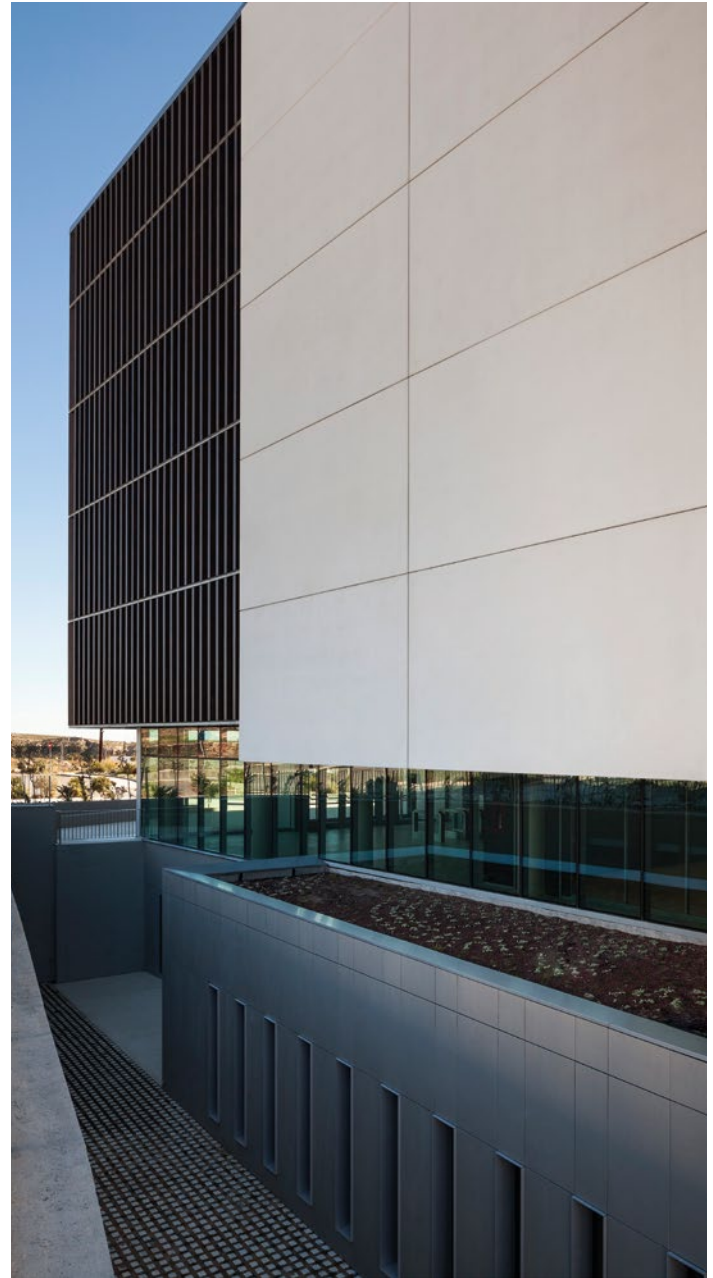

CASE STUDY

444N Orleans Building

Chicago, USA

Material

Dekton® Aura Bookmatch

Facade system

DKBG

Thickness

12mm







DK c

Chemical Anchor System

DKC is a totally chemical fixing system, which allows parts to be glued directly to the supporting substructure with structural adhesives, avoiding any machining of the part. Starting from a profile, two strips of double-sided tape are placed in the center while they are added to the perimeter of said profile.

During fixing, the double-sided tape secures the piece while the adhesive is curing. You can work with a wide range of formats and even design pre-assembled elements in the factory. This system allows a wide range of thicknesses, with 8mm pieces being the most demanded in renovation works and for changes of image.



Fixing with chemical anchoring on profiles.



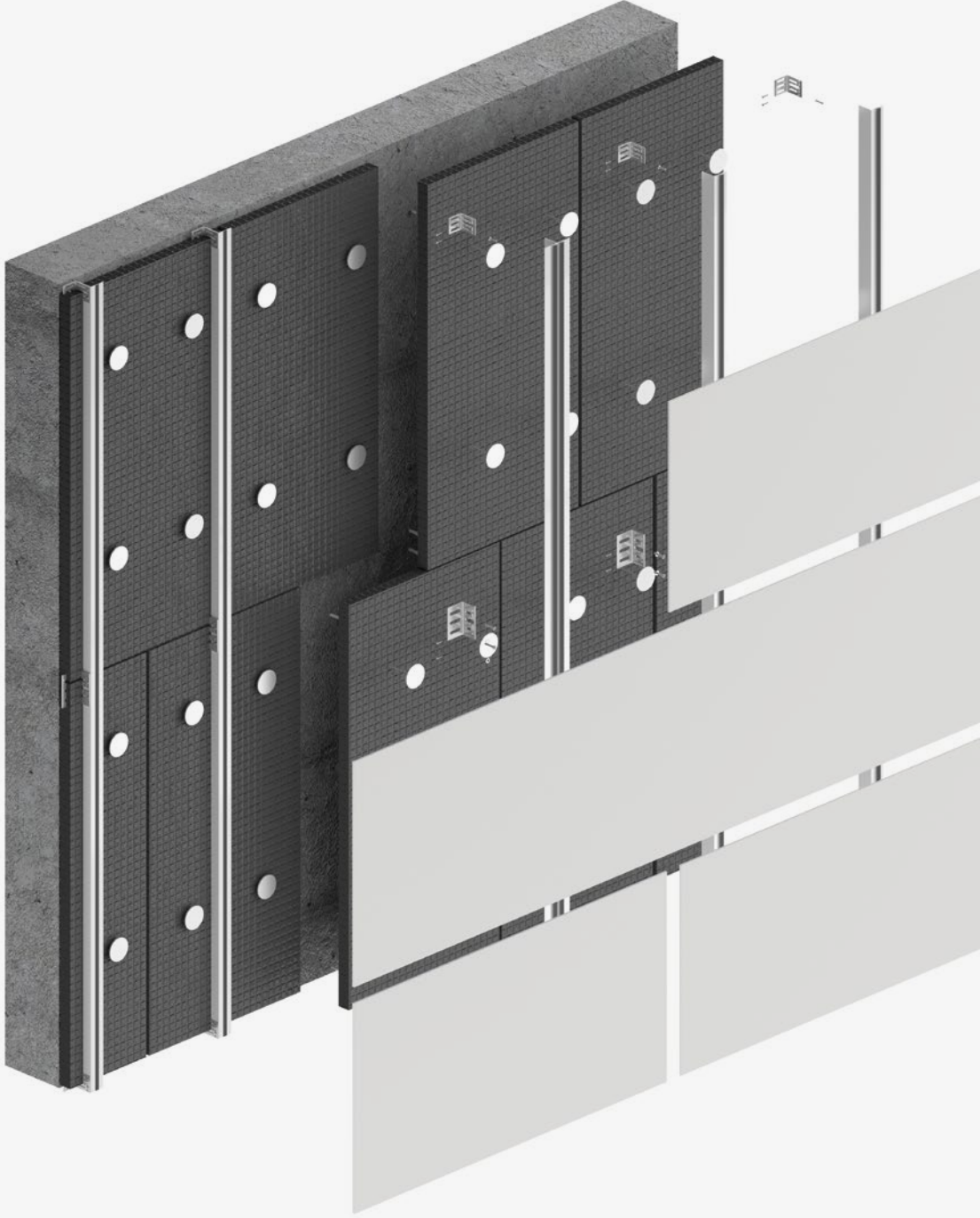

DKC - Diagram

Substructure



Chemical anchor system

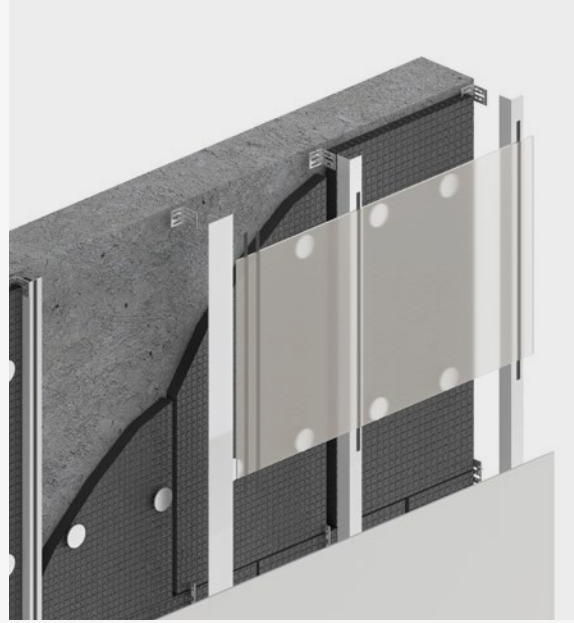

Joint

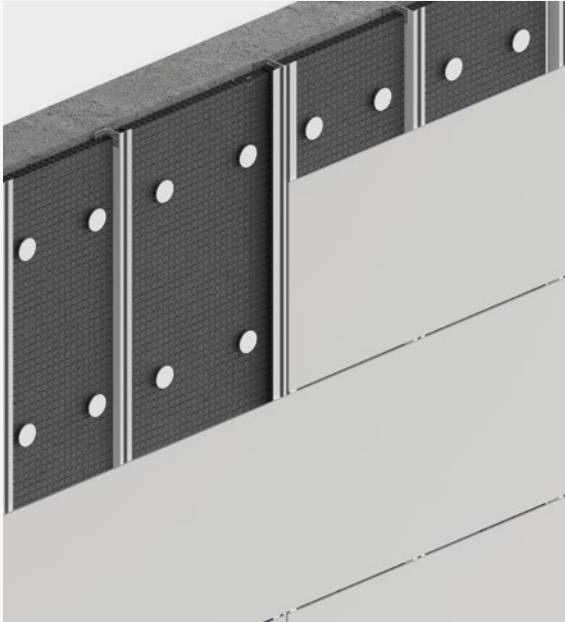

System detail

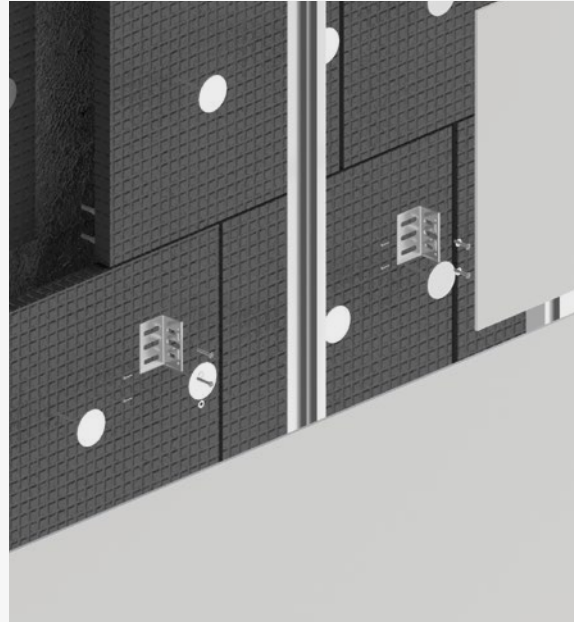

DKC Horizontal section

Mitered external corner

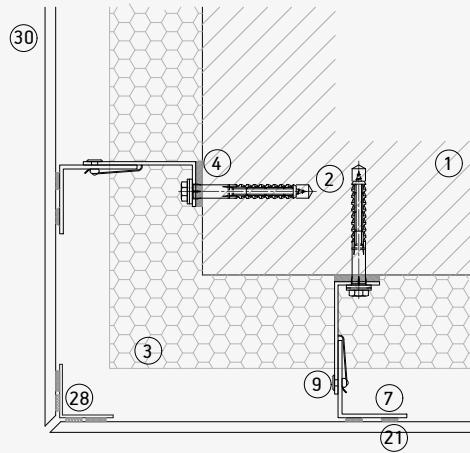

Internal Corner

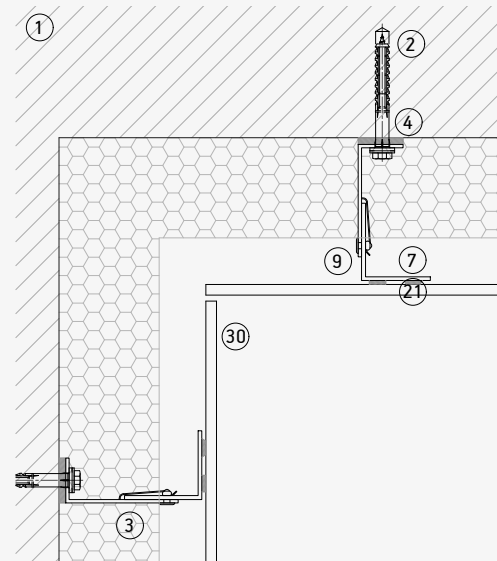

Vertical joint

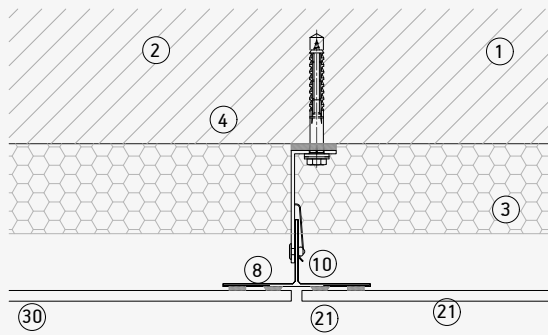

Vertical expansion joint

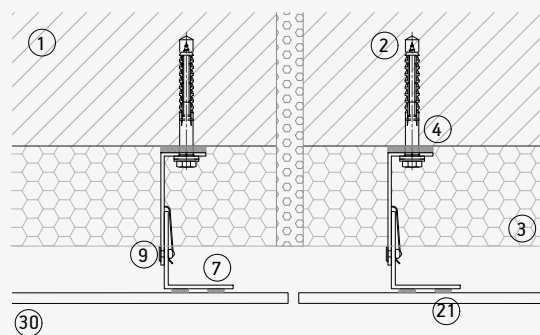

- 1. Supporting wall.
- 2. Anchor bracket.
- 3. Insulation.
- 4. Insulating layer.
- 5. Fixed bracket.
- 6. Adjustable bracket.
- 7. L profile.
- 8. T profile.
- 9. Self tapping screw.

- 10. Rivet.
- 11. Undercut anchor.
- 12. Horizontal rail.
- 13. C hanger.
- 14. Adjustable C hanger.
- 15. Bottom/top edge profile/clip.
- 16. Intermediate edge profile/clip.

- 17. Bottom/top visible clip.
- 18. Intermediate visible clip.
- 19. Interior back clip
- 20. Exterior back profile
- 21. Chemical fixing system
- 22. Security fixing
- 23. Ventilation profile
- 24. Lintel
- 25. Jamb

- 26. Window sill
- 27. Top coping
- 28. Corner profile
- 29. Bonding adhesive
- 30. Dekton

DKC Vertical section

Upper detail

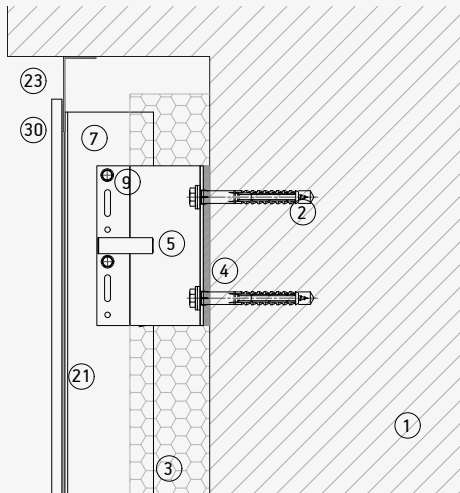

Bottom detail

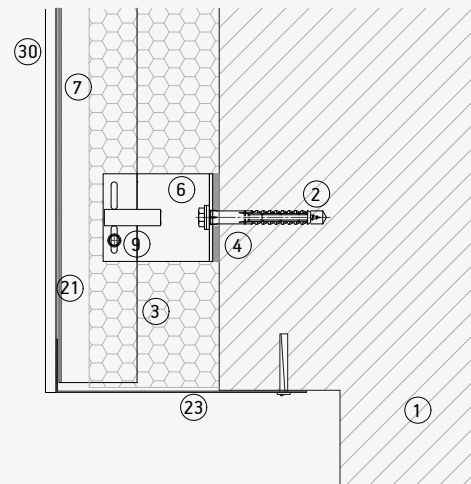

Horizontal joint

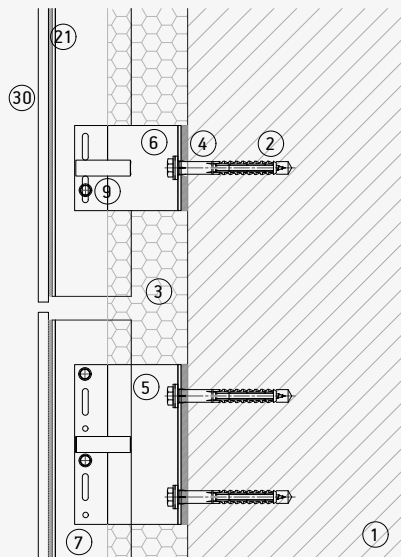

Joint between profiles

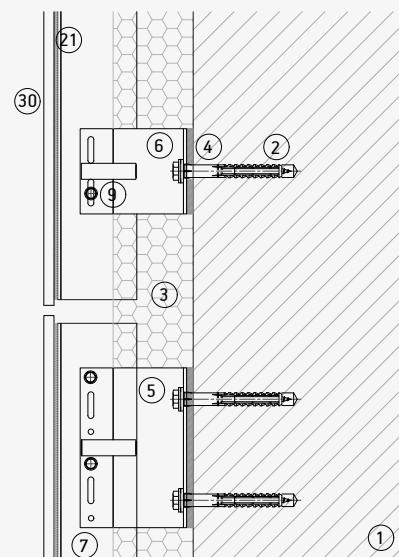

- | | | | |
|------------------------|-------------------------------------|--------------------------------|----------------------|
| 1. Supporting wall. | 10. Rivet. | 17. Bottom/top visible clip. | 26. Window sill |
| 2. Anchor bracket. | 11. Undercut anchor. | 18. Intermediate visible clip. | 27. Top coping |
| 3. Insulation. | 12. Horizontal rail. | 19. Interior back clip | 28. Corner profile |
| 4. Insulating layer. | 13. C hanger. | 20. Exterior back profile | 29. Bonding adhesive |
| 5. Fixed bracket. | 14. Adjustable C hanger. | 21. Chemical fixing system | 30. Dekton |
| 6. Adjustable bracket. | 15. Bottom/top edge profile/clip. | 22. Security fixing | |
| 7. L profile. | 16. Intermediate edge profile/clip. | 23. Ventilation profile | |
| 8. T profile. | | 24. Lintel | |
| 9. Self tapping screw. | | 25. Jamb | |

DKC Sections

Dekton jamb

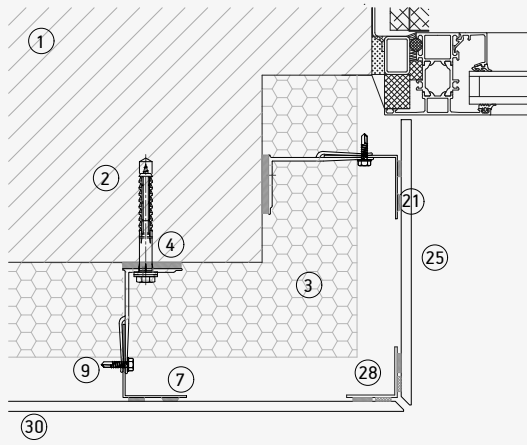

Window section without jambs

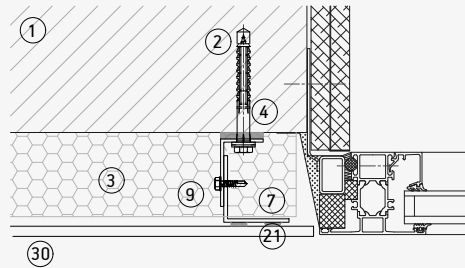

Window without sill

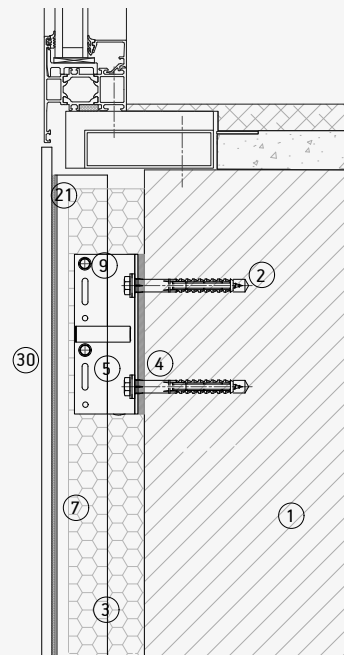

Dekton lintel

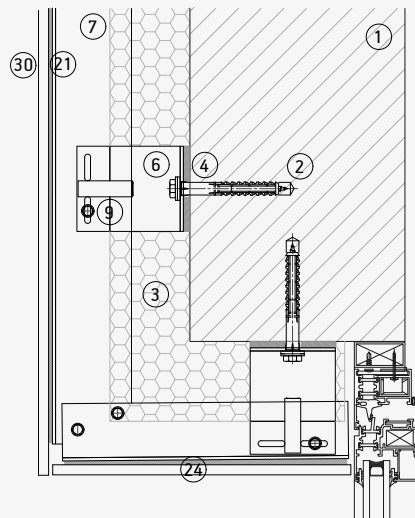

- | | | | |
|------------------------|-------------------------------------|--------------------------------|----------------------|
| 1. Supporting wall. | 10. Rivet. | 17. Bottom/top visible clip. | 26. Window sill |
| 2. Anchor bracket. | 11. Undercut anchor. | 18. Intermediate visible clip. | 27. Top coping |
| 3. Insulation. | 12. Horizontal rail. | 19. Interior back clip | 28. Corner profile |
| 4. Insulating layer. | 13. C hanger. | 20. Exterior back profile | 29. Bonding adhesive |
| 5. Fixed bracket. | 14. Adjustable C hanger. | 21. Chemical fixing system | 30. Dekton |
| 6. Adjustable bracket. | 15. Bottom/top edge profile/clip. | 22. Security fixing | |
| 7. L profile. | 16. Intermediate edge profile/clip. | 23. Ventilation profile | |
| 8. T profile. | | 24. Lintel | |
| 9. Self tapping screw. | | 25. Jamb | |

DKC System Description

Hidden system

Supporting substructure made up of; metal brackets, adjustable for the correction of unevenness compatible with different types of supports, can include thermal break insulator; vertical metal profiles of different sections; hidden system of chemical fixing by means of adhesive to the back of the Dekton Panel, according to the manufacturer's recommendations for its application.

Installation process

Brackets installed on the surface to be covered by means of a mechanical system or welding; vertical profiles installed on brackets with a regulation and fixing system, by means of specific screws*; possible installation of accessories according to the requirements of the manufacturer of the chemical system and subsequent installation of the adhesive to the vertical profile as indicated; installation of the panel to the chemical system by means of support from the back of the Dekton panel.

*Specific screws according to the structural calculation of each project or indicated by the supplier of the substructure.



DKC Structure



General fixing instructions

Vertical rails should be placed following general subframe installation, in a single vertical plane.

- A predetermined horizontal datum is marked on the support frame; the first row determines the uniformity of the gaps and panel alignment throughout the façade installation.

Carrier rail preparation:

- Treat the bonding surfaces per adhesive provider's recommendations, applying a uniform layer of adhesion promoter over the vertical profiles surface if needed and allowing it to dry per the instructions given.

Dekton Panel preparation (non-porous material):

- Clean the bonding surface ensuring it is dry and grease free.
- Apply adhesion promoter if needed per supplier's instructions.
- Apply the adhesion promoter uniformly per supplier's instructions.

Adhesive application:

- Place the double-sided adhesive tape on the vertical profiles to provide temporary support to Dekton pieces while adhesive is curing and ensure the consistency of the adhesive applied.

- Apply the continuous, uniform lines of adhesive along the vertical profiles, approximately 10mm away from the adhesive tape, panel by panel. It is recommended using a battery or compressed air powered applicator.

Panel installation:

- The initial panel is positioned on the bottom edge and aligned. Press the panel against the adhesive, and correct bedding of adhesive.
- Consecutive Dekton panels are placed in a similar way, using temporary packers to achieve uniform joints between panels. The gaps should be calculated to allow thermal movement of pieces and rails.

Installation sequence from left to right and from top to bottom

Fig. 1

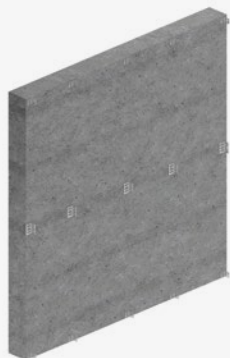

Fig. 2

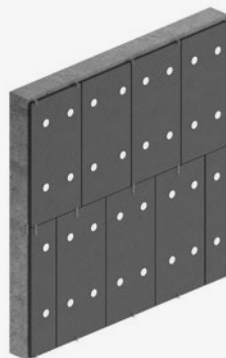

Fig. 3



Fig. 4



Fig. 5



Fig. 6



DKC Static Calculations

Panel in horizontal or vertical layout. Maximum wind loads shown in the following configurations depend on the grid spacing and distance from drill holes to the edges.

These configurations have been calculated considering a distance of fixing to edges of 200mm. For further

distances and configurations please consult our Technical Department.

These configurations are based on a Dekton calculation software® and refer only to Dekton®. They cannot be considered as definitive data for on-site installation and require a competent technician to perform a project-specific calculation for the entire front-end system including support anchors, brackets, profiling, hardware and Dekton® fixings to the front.

How to use the reference configurations:

- Determine the design wind load in kN/m².
- Choose the table according to the fixing system and Dekton thickness.
- Select the closest design wind load. The wind load chosen should not be less than actual requirements.
- Select a reference configuration showing maximum spacing between fixings.

DKC

Dekton 4mm

Full slab configuration

Design wind load kN/m ²	Horizontal	Spacing between horiz. profiles (mm)	Vertical	Spacing between vert. profiles (mm)
0.5	H2	800	V1	720
2	H3	540	-	-
2.5	H5	460	V2	480
4	-	-	V3	360

Dekton 8mm

Full slab configuration

Design wind load kN/m ²	Horizontal	Spacing between horiz. profiles (mm)	Vertical	Spacing between vert. profiles (mm)
2	H1	1070	-	
3	H2	800	-	
3.5	-		V1	720
5	H4	640	-	-
11	-		V2	480

Design wind loads to be compared with reference design wind loads provided in this document should have applied wind load factors on characteristic values per applicable standards and regulations.

Design wind loads and fixing distances should be calculated per local standards, regulations and certificates applicable, with further testing if required.

Cosentino does not provide static calculations for projects.

Cosentino will not accept any liability whatsoever for any direct or indirect damage resulting from any errors, omissions or miscalculations of the static calculations for the project.

DKC. Layout

4mm HORIZONTAL CONFIGURATION

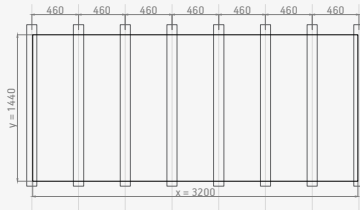

H5. Max. Design wind load: 2.5 kN/m²

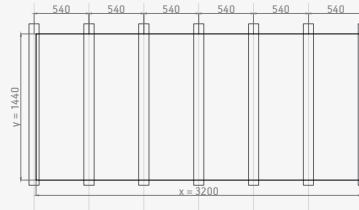

H3. Max. Design wind load: 2.0 kN/m²

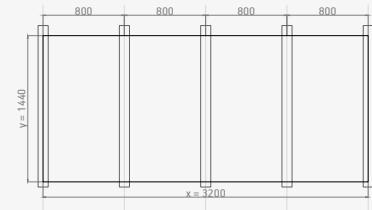

H2. Max. Design wind load: 0.5 kN/m²

VERTICAL CONFIGURATION

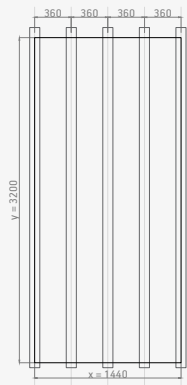

V3. Max. Design wind load: 4.0 kN/m²

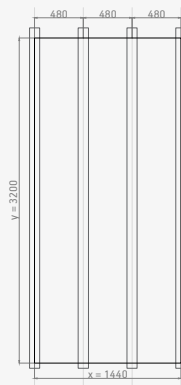

V2. Max. Design wind load: 2.5 kN/m²

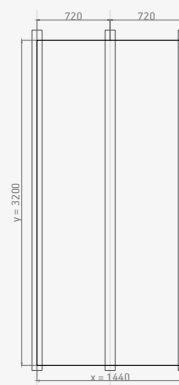

V1. Max. Design wind load: 0.5 kN/m²

8mm HORIZONTAL CONFIGURATION

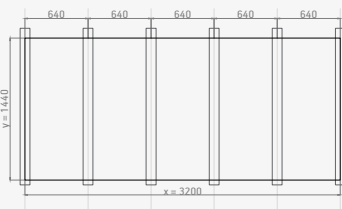

H4. Max. Design wind load: 5.0 kN/m²

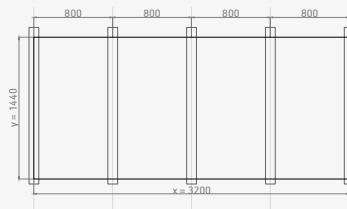

H2. Max. Design wind load: 3.0 kN/m²

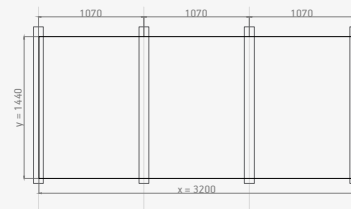

H1. Max. Design wind load: 2.0 kN/m²

VERTICAL CONFIGURATION

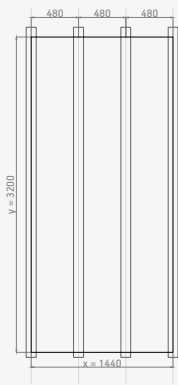

V2. Max. Design wind load: 11.0 kN/m²

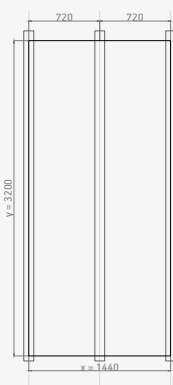

V1. Max. Design wind load: 3.5 kN/m²

CASE STUDY

Leonardo Building

Johannesburg, South Africa

Material

20,000 m² Dekton[®] Gada

Facade system

DKC

Thickness

8mm



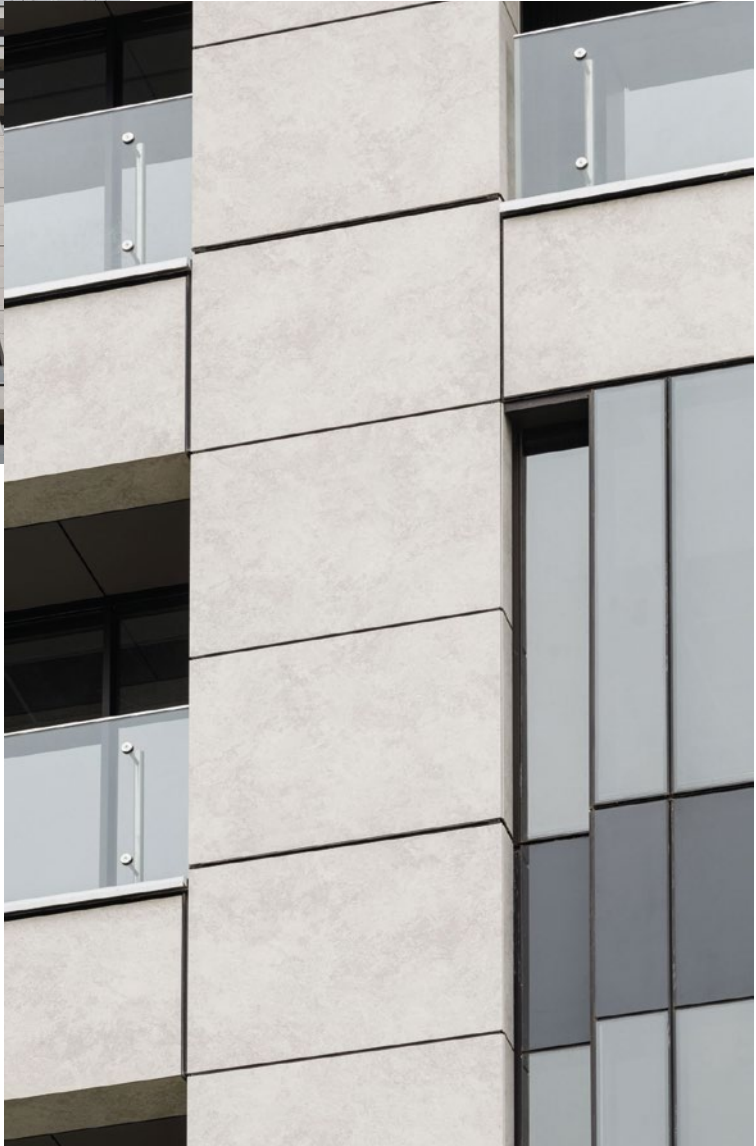

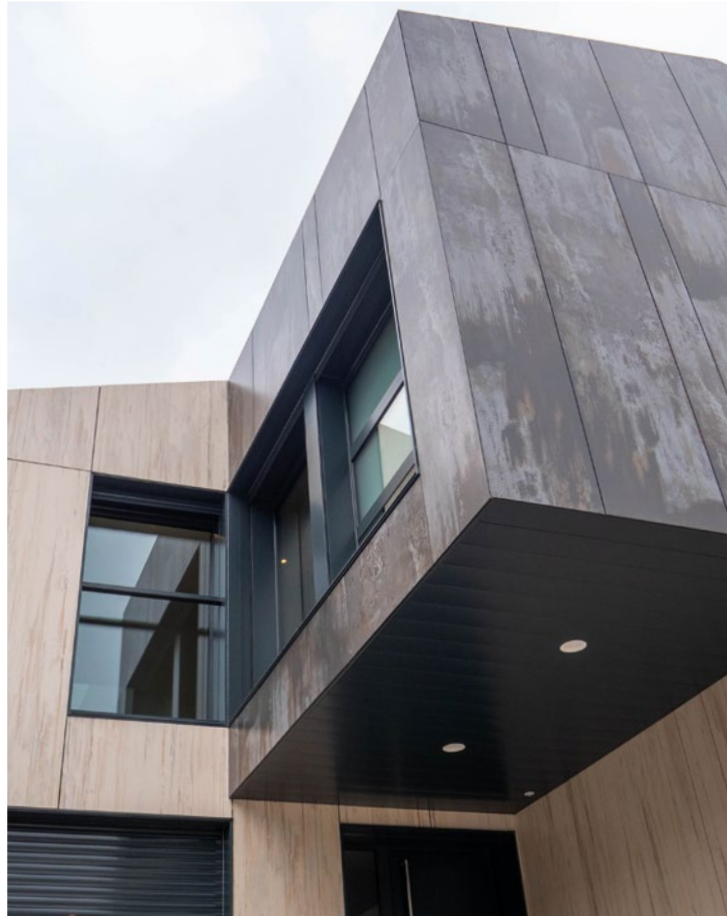

CASE STUDY

Family home in Álava

Álava, Spain

Material

600 m² Dekton® Trilium
120 m² Dekton® Makay

Facade system

DKC

Thickness

4 and 8 mm





DK B

Direct Adhesion

The DKB system is a glued facade system, without format limitations and where 8mm thickness is commonly used. Each piece is applied directly to the cladding, thanks to a layer of improved cement based adhesive applied according to the technique of double gluing on the support and back of the piece, leaving horizontal

and vertical joints of at least 3mm. Generally, the use of hidden security clips is always recommended (and is compulsory in some places according to local standards), slotting the edge of the piece or making a regular groove on the back, and always following the local regulations applicable to each project.



Chemical fixation
adhered directly
on the supporting wall.

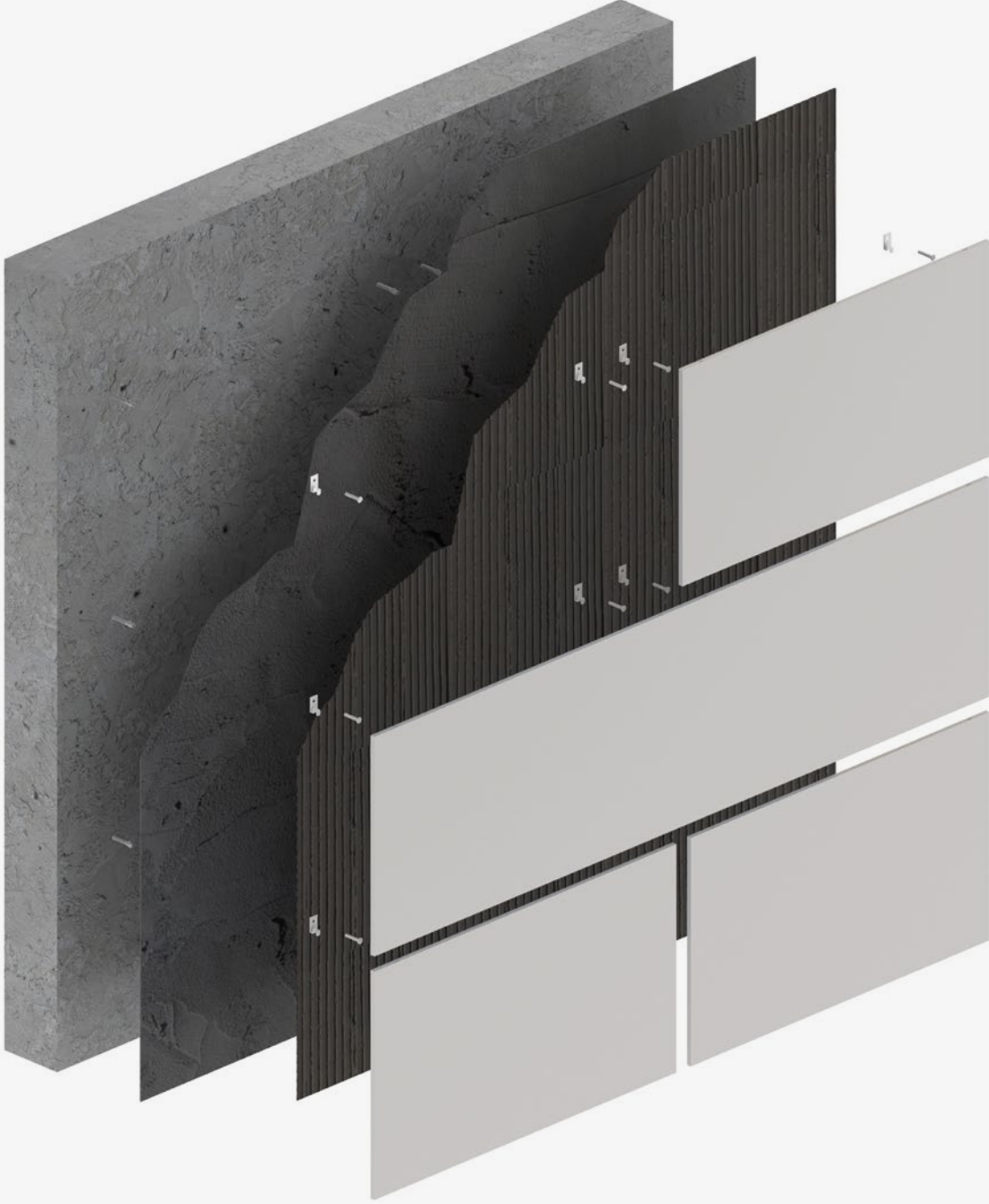

DKB - Diagram

Joint

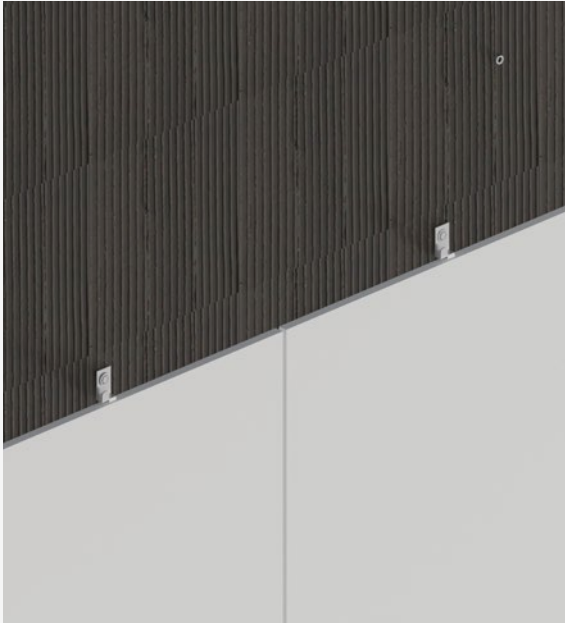

Detail of system layers



Bottom

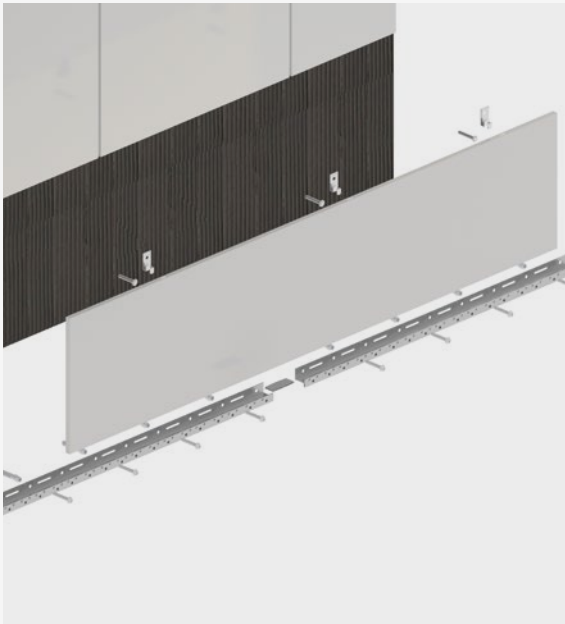

System detail

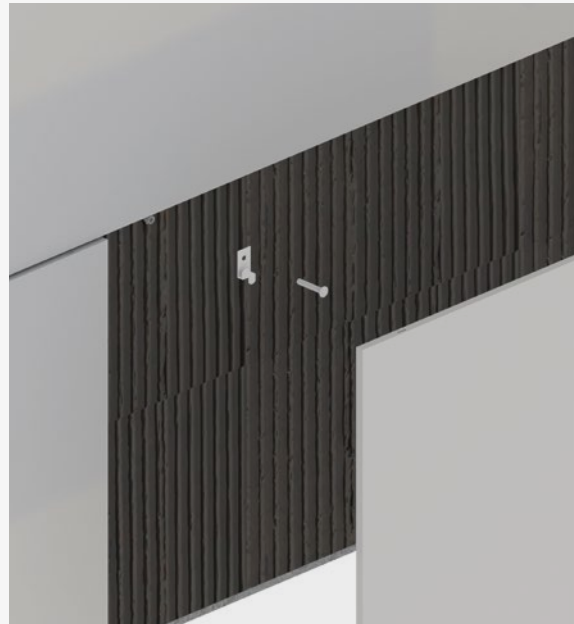

DKB Structure



General fixing instructions

1. Clean, prepare and level the supporting wall.
2. Apply the adhesive to both the supporting wall and the Dekton® pieces with toothed trowel.
3. Place the Dekton® pieces.
4. Meeting of the placement joints.
5. Fill the joints with grout.
6. Removal and cleaning of excess material.
7. Final cleaning of the facade.

Fig. 1



Fig. 2



Fig. 3



Fig. 4



Fig. 5



Fig. 6



Fig. 7



Fig. 8



DKB System Description

Dekton® ultra-compact surface by COSENTINO, colour to be defined by the Project Management*, mineral composition, thickness 4, 8 or 12 mm. The surface is made up of 25,000 tons of pressed material (>450 kg/cm) and sintered at a temperature of around 1,200 °C, with a useful size of 3200 x 1440 mm and a smooth back (slightly textured, without ribs). Reaction to fire Class A1 [according to EN 13501], unaffected by UV radiation [$\Delta E < 1$ tested in a Xenon chamber at 5000h], with thermal conductivity < 0.5 W/m- °C [according to EN12664], specific heat < 700 J/Kg- °C [measured with DSC], surface resistivity < 65 TΩ/m [at 1000

V] and must have these mechanical-functional characteristics according to EN 10545: Bending strength > 45 N/mm. Density > 2,500 Kg/m³. Porosity < 0.05 %. Linear expansion < 10-6 °C-1. Can be used in outdoor environments, even aggressive ones (petrol, diesel, various solvents) and cleaned with water or other pressurised products, using commercial cleaning products or specific chemical agents (e.g. sulphuric acid, bleach, hydrogen peroxide, acetone, caustic soda) in the case of persistent stains. Applied as a cladding for facades, mixed with cement based adhesive in a thin layer with double gluing and mechanical safety fixings to the substrate. Type

C2TES2 adhesive for Dekton® without mesh and type R2 adhesive (according to UNE EN 12004) for Dekton® with mesh, with improved adhesion, reduced slip, extended open time and very formable. 3-5 mm wide placement joints, grouted with cement mortar with high resistance to abrasion and reduced absorption type CG2AW (according to UNE EN 13888). Expansion joints every 16 m² or 4 linear metres, perimeter joints and expansion joints following structural expansion joints of the building. Upper end of the façade with a special piece for water drips, with the façade meeting resolved with a perimeter joint.

Size, thickness and finishes

Full slab format	320 x 144 cm
Thickness (cm)	0.4 ⁽¹⁾ – 0.8 – 1.2
Finishes	Smooth, Textured or Polished

(1) The 4mm. thickness incorporates 300 g/m² glass fibre mesh with epoxy resin and is called Dekton® Protek.

Recommended size of slabs in this system to minimize waste

Formats (cm)	Formats (inches)	N° of pieces
71 x 71	28" x 28"	8
71 x 106	28" x 42"	6
71 x 142	28" x 56"	4
71 x 159	28" x 63"	4
71 x 320	28" x 126"	2
106 x 142	42" x 56"	3
142 x 142	56" x 56"	2
142 x 159	56" x 63"	2

DKB Horizontal section

External corner bevelled

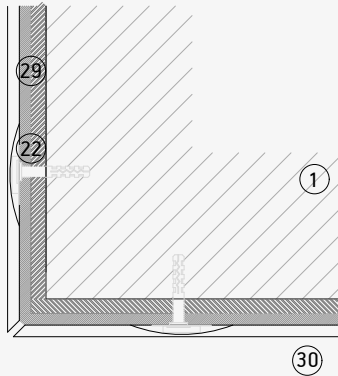

Internal Corner

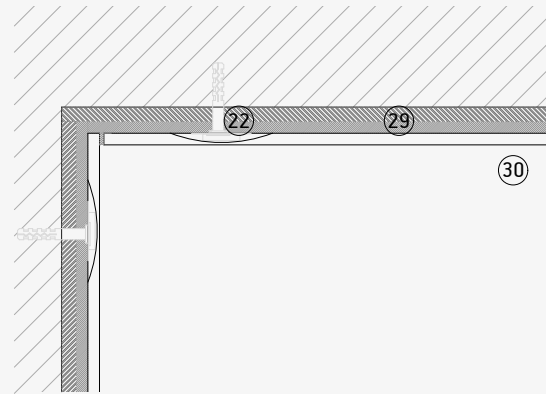

Vertical joint

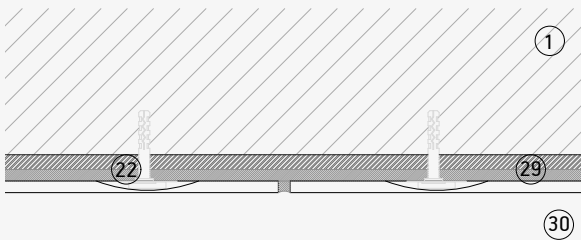

Vertical expansion joint

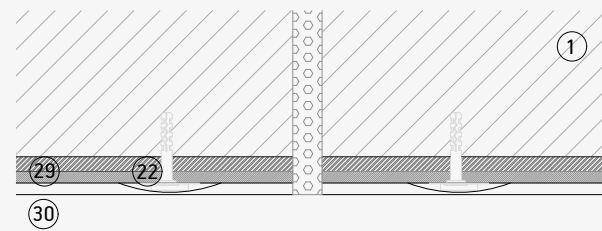

- | | | | |
|------------------------|-------------------------------------|--------------------------------|----------------------|
| 1. Supporting wall. | 10. Rivet. | 17. Bottom/top visible clip. | 26. Window sill |
| 2. Anchor bracket. | 11. Undercut anchor. | 18. Intermediate visible clip. | 27. Top coping |
| 3. Insulation. | 12. Horizontal rail. | 19. Interior back clip | 28. Corner profile |
| 4. Insulating layer. | 13. C hanger. | 20. Exterior back profile | 29. Bonding adhesive |
| 5. Fixed bracket. | 14. Adjustable C hanger. | 21. Chemical fixing system | 30. Dekton |
| 6. Adjustable bracket. | 15. Bottom/top edge profile/clip. | 22. Security fixing | |
| 7. L profile. | 16. Intermediate edge profile/clip. | 23. Ventilation profile | |
| 8. T profile. | | 24. Lintel | |
| 9. Self tapping screw. | | 25. Jamb | |

DKB Vertical section

Upper detail

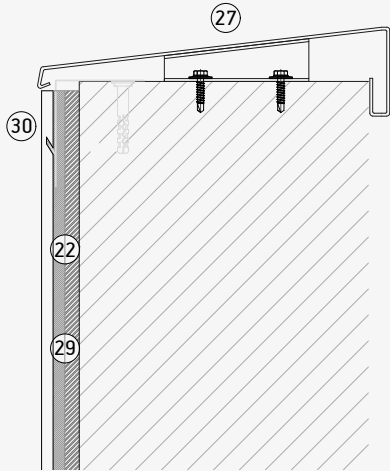

Bottom detail

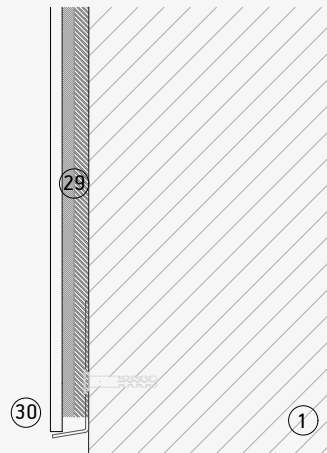

Horizontal joint

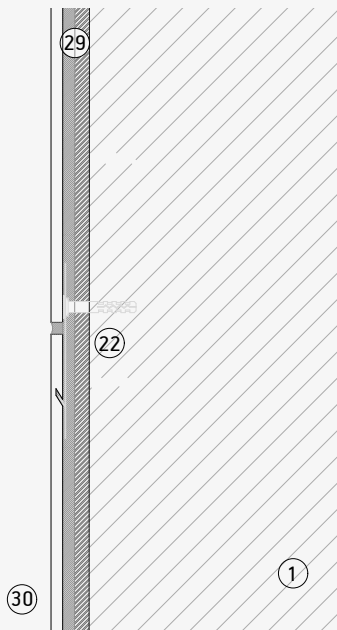

Horizontal profiles joint

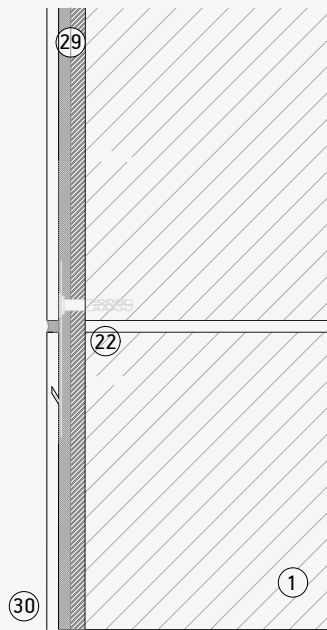

- | | | | |
|------------------------|-------------------------------------|--------------------------------|----------------------|
| 1. Supporting wall. | 10. Rivet. | 17. Bottom/top visible clip. | 26. Window sill |
| 2. Anchor bracket. | 11. Undercut anchor. | 18. Intermediate visible clip. | 27. Top coping |
| 3. Insulation. | 12. Horizontal rail. | 19. Interior back clip | 28. Corner profile |
| 4. Insulating layer. | 13. C hanger. | 20. Exterior back profile | 29. Bonding adhesive |
| 5. Fixed bracket. | 14. Adjustable C hanger. | 21. Chemical fixing system | 30. Dekton |
| 6. Adjustable bracket. | 15. Bottom/top edge profile/clip. | 22. Security fixing | |
| 7. L profile. | 16. Intermediate edge profile/clip. | 23. Ventilation profile | |
| 8. T profile. | | 24. Lintel | |
| 9. Self tapping screw. | | 25. Jamb | |

DKB Vertical section

Dekton jamb

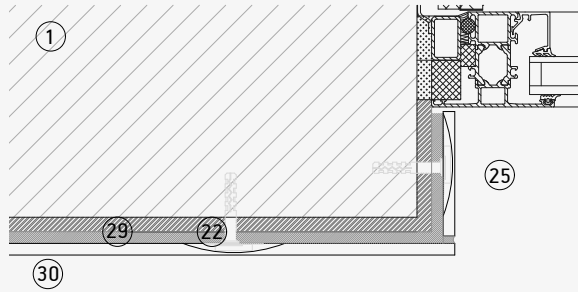

Metallic jamb



Dekton window sill

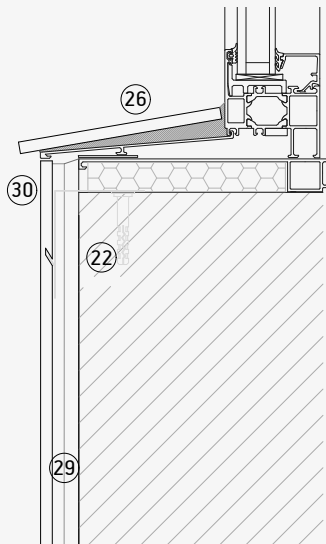

Dekton lintel

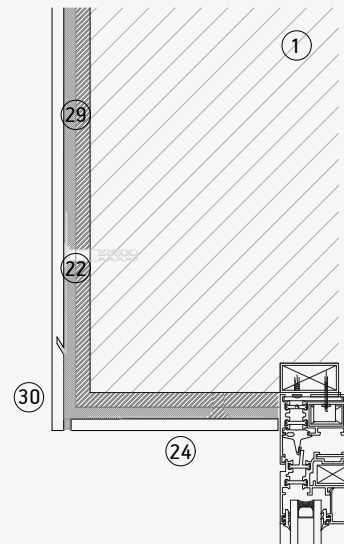

- | | | | |
|------------------------|-------------------------------------|--------------------------------|----------------------|
| 1. Supporting wall. | 10. Rivet. | 17. Bottom/top visible clip. | 26. Window sill |
| 2. Anchor bracket. | 11. Undercut anchor. | 18. Intermediate visible clip. | 27. Top coping |
| 3. Insulation. | 12. Horizontal rail. | 19. Interior back clip | 28. Corner profile |
| 4. Insulating layer. | 13. C hanger. | 20. Exterior back profile | 29. Bonding adhesive |
| 5. Fixed bracket. | 14. Adjustable C hanger. | 21. Chemical fixing system | 30. Dekton |
| 6. Adjustable bracket. | 15. Bottom/top edge profile/clip. | 22. Security fixing | |
| 7. L profile. | 16. Intermediate edge profile/clip. | 23. Ventilation profile | |
| 8. T profile. | | 24. Lintel | |
| 9. Self tapping screw. | | 25. Jamb | |



DK S

ETICS/EIFS System

In our fast-moving world, homes undergo multiple refurbishments for aesthetic and decorative reasons as well as to create warmer indoor environments. The DKS system is an ETICS (External Thermal Insulation Composite System) finishing solution.

On an ETICS that is ready to be finished with cladding, Dekton is applied using a suitable cement based adhesive. Because the pieces are adhered to the finished reinforced layer of the insulation system, there is a limit to the weight and format, which must be indicated

by the ETICS supplier. The product and application instructions of the ETICS supplier must be followed to fully guarantee the application.



Fixing pieces of an external thermal insulation (ETICS) project of high energy-efficiency.

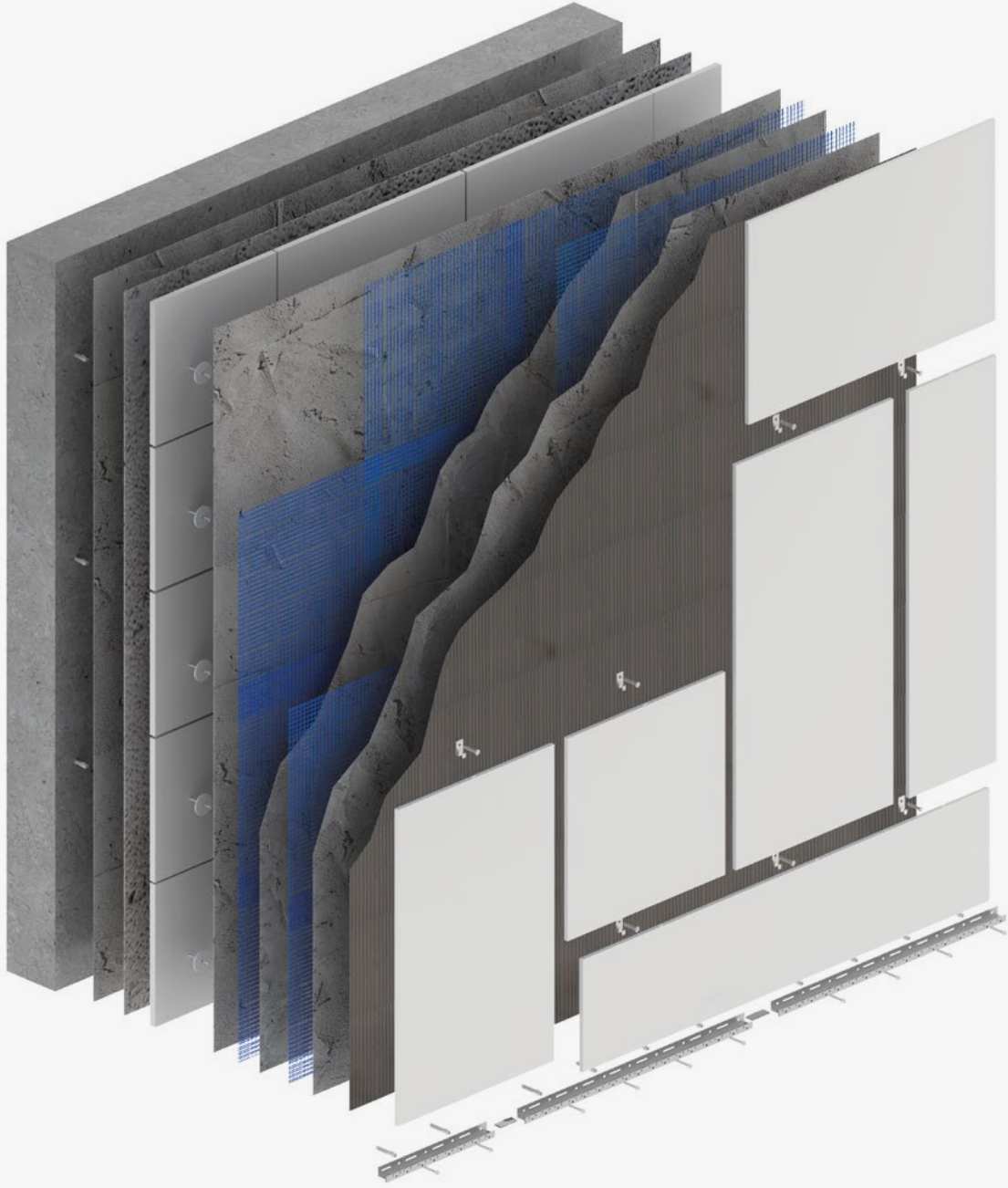

DKS - Diagram

Starting profile

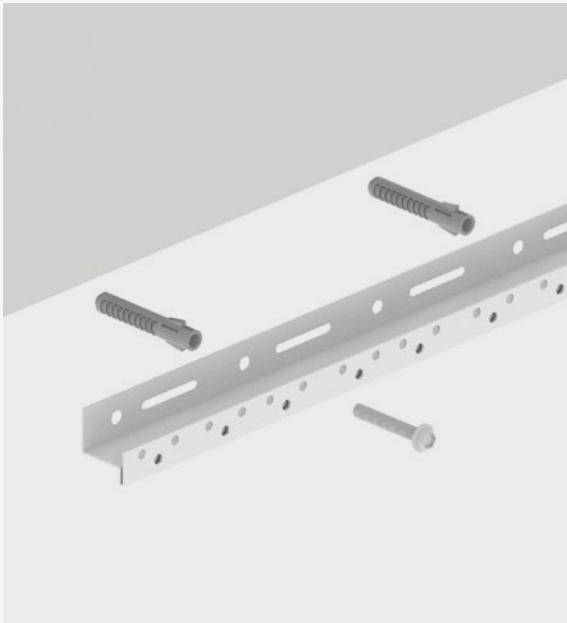

System Detail

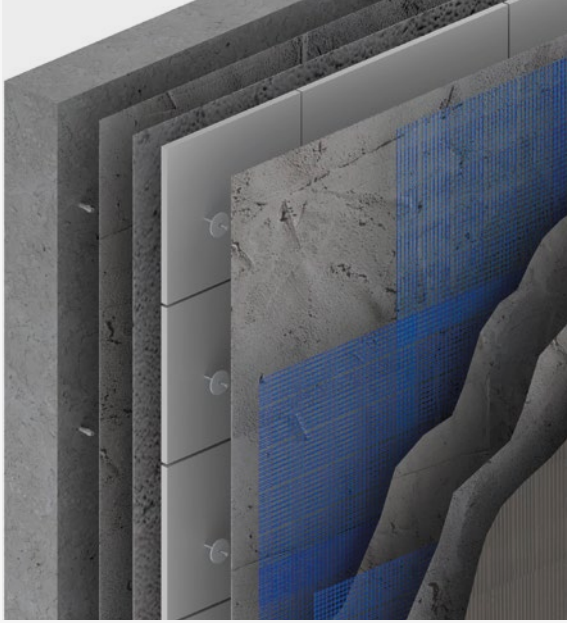

Bottom Slab

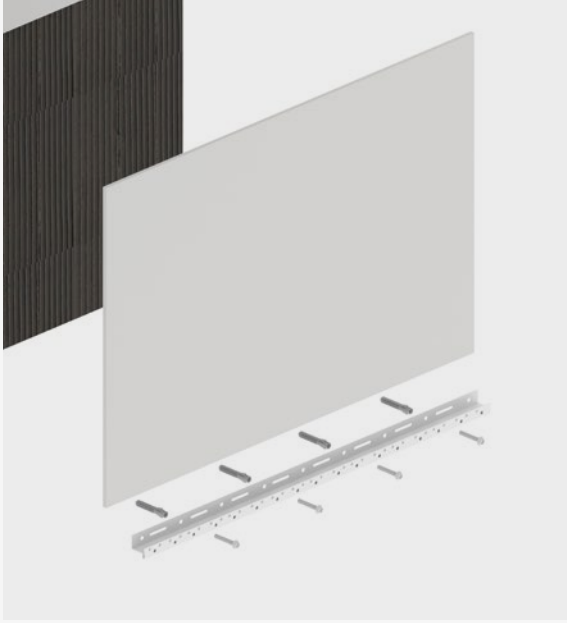

System detail



DKS Horizontal section

External corner

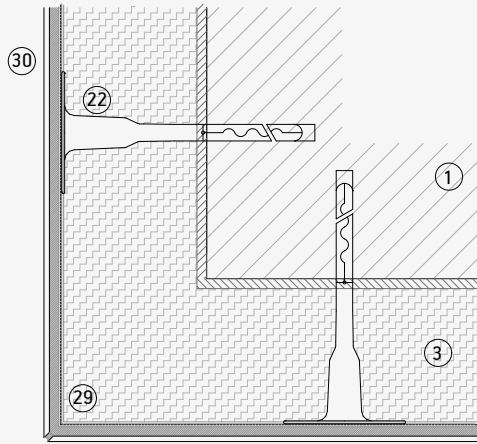

Internal Corner

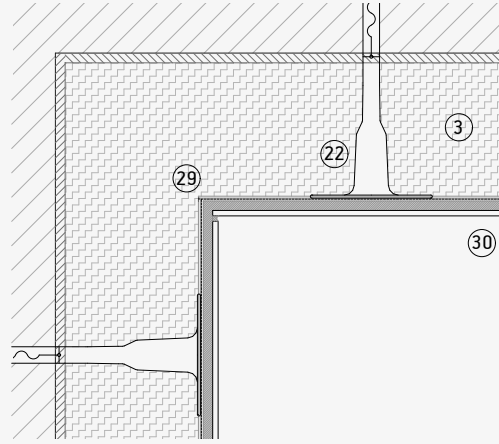

Vertical joint

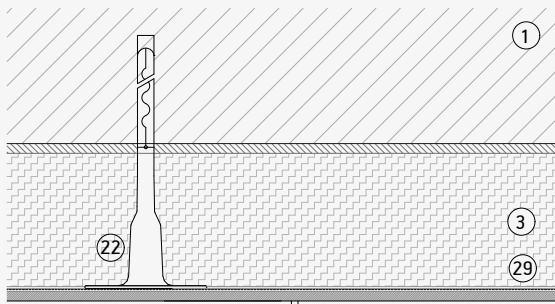

Vertical expansion joint

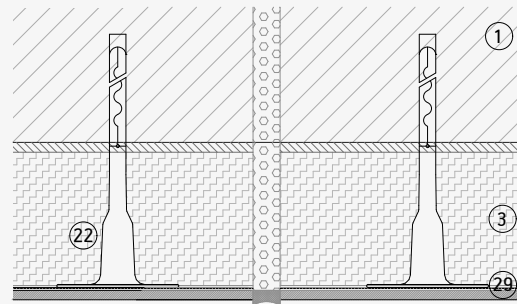

- 1. Supporting wall.
- 2. Anchor bracket.
- 3. Insulation.
- 4. Insulating layer.
- 5. Fixed bracket.
- 6. Adjustable bracket.
- 7. L profile.
- 8. T profile.
- 9. Self tapping screw.

- 10. Rivet.
- 11. Undercut anchor.
- 12. Horizontal rail.
- 13. C hanger.
- 14. Adjustable C hanger.
- 15. Bottom/top edge profile/clip.
- 16. Intermediate edge profile/clip.

- 17. Bottom/top visible clip.
- 18. Intermediate visible clip.
- 19. Interior back clip
- 20. Exterior back profile
- 21. Chemical fixing system
- 22. Security fixing
- 23. Ventilation profile
- 24. Lintel
- 25. Jamb

- 26. Window sill
- 27. Top coping
- 28. Corner profile
- 29. Bonding adhesive
- 30. Dekton

DKS Vertical section

Upper detail

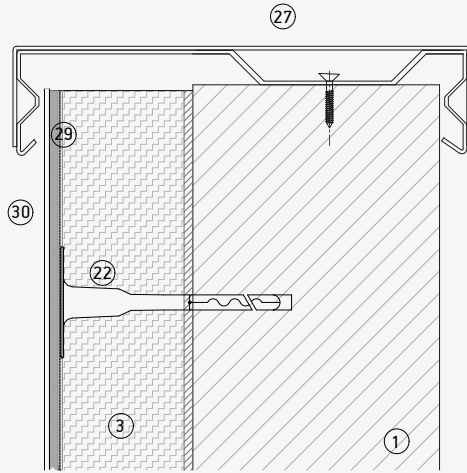

Bottom detail

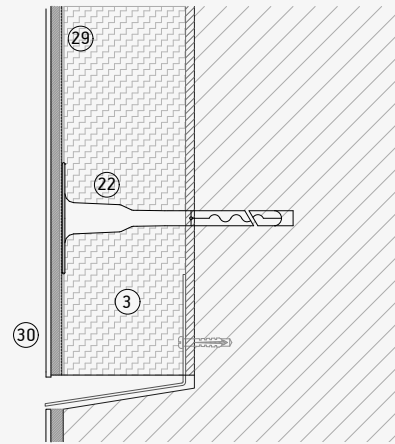

Horizontal joint

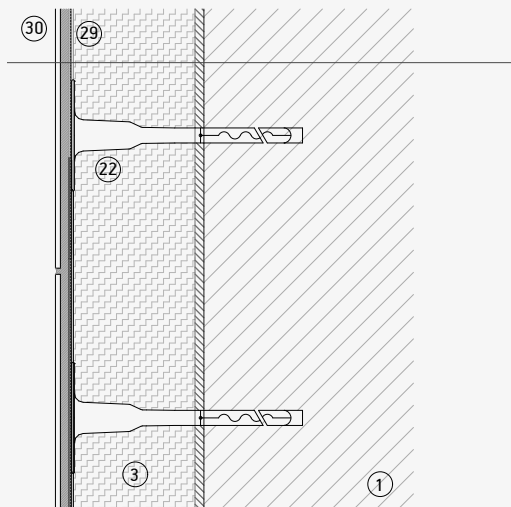

Horizontal profiles joint

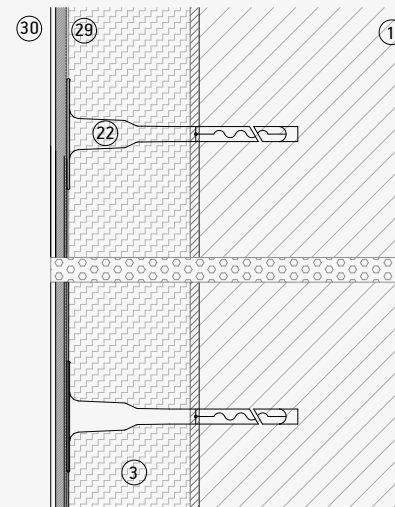

- | | | | |
|------------------------|-------------------------------------|--------------------------------|----------------------|
| 1. Supporting wall. | 10. Rivet. | 17. Bottom/top visible clip. | 26. Window sill |
| 2. Anchor bracket. | 11. Undercut anchor. | 18. Intermediate visible clip. | 27. Top coping |
| 3. Insulation. | 12. Horizontal rail. | 19. Interior back clip | 28. Corner profile |
| 4. Insulating layer. | 13. C hanger. | 20. Exterior back profile | 29. Bonding adhesive |
| 5. Fixed bracket. | 14. Adjustable C hanger. | 21. Chemical fixing system | 30. Dekton |
| 6. Adjustable bracket. | 15. Bottom/top edge profile/clip. | 22. Security fixing | |
| 7. L profile. | 16. Intermediate edge profile/clip. | 23. Ventilation profile | |
| 8. T profile. | | 24. Lintel | |
| 9. Self tapping screw. | | 25. Jamb | |

DKS Vertical section

Dekton jamb

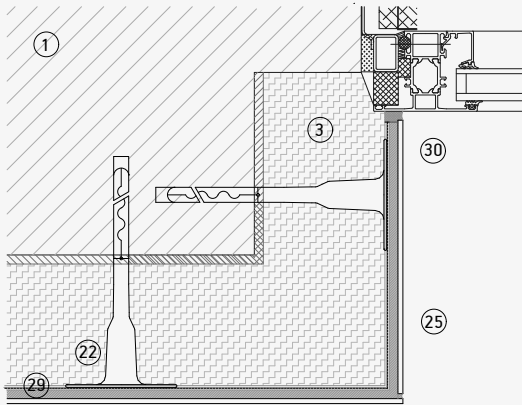

Metallic jamb

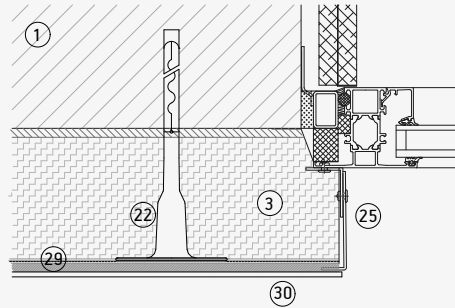

Dekton window sill

Dekton lintel

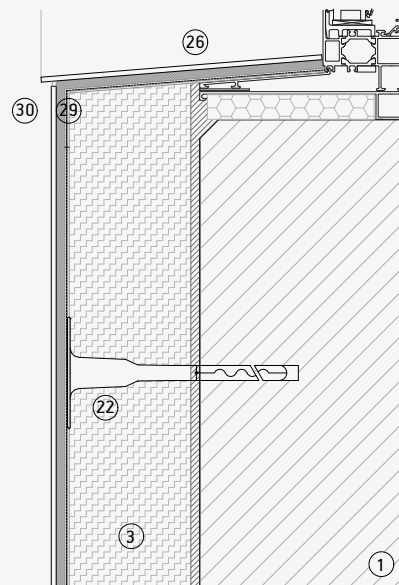
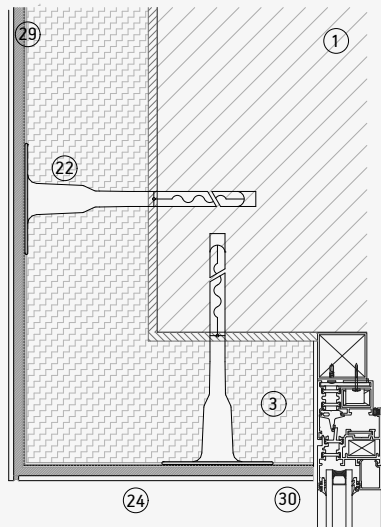

1. Supporting wall.
2. Anchor bracket.

3. Insulation.
4. Insulating layer.
5. Fixed bracket.
6. Adjustable bracket.
7. L profile.
8. T profile.

9. Self tapping screw.
10. Rivet.
11. Undercut anchor.
12. Horizontal rail.
13. C hanger.
14. Adjustable C hanger.
15. Bottom/top edge profile/clip.
16. Intermediate

edge profile/clip.
17. Bottom/top visible clip.
18. Intermediate visible clip.
19. Interior back clip
20. Exterior back profile
21. Chemical fixing system
22. Security fixing
23. Ventilation profile
24. Lintel

25. Jamb
26. Window sill
27. Top coping
28. Corner profile
29. Bonding adhesive
30. Dekton

DKS System Description

Dekton® ultra-compact surface by Cosentino, Colour to be defined by the Project Management*. Mineral composition formed by pressing 25,000 Tons (>450 kg/cm) and subsequent sintering at temperatures around 1,200 °C, with useful dimension 3.20x1.44 m, thickness 4 mm without mesh or 8 mm with mesh, incorporating fibreglass mesh 300 g/m² with epoxy resin; reaction to fire Class A1 or A2 s1 d0 [according to EN 13501], unaffected by UV radiation [$\Delta E < 1$ tested in a Xenon chamber at 5000h], with thermal conductivity $< 0.5 \text{ W/m} \cdot ^\circ\text{C}$ [according to EN12664], specific heat $< 700 \text{ J/Kg} \cdot ^\circ\text{C}$ [measured with DSC], surface resistivity $< 65 \text{ T}\Omega/\text{m}$ [at 1000 V] and must have these mechanical-functional characteristics according to EN 10545: Bending strength $> 55 \text{ N/mm}$. Density $> 2,500 \text{ Kg/m}^3$. Porosity $< 0.05 \%$. Linear expansion $< 10^{-6} \text{ } ^\circ\text{C}^{-1}$. Can be used in outdoor environments, even aggressive ones (petrol, diesel, various solvents) and cleaned with

water or other pressurised products, using commercial cleaning products or specific chemical agents (e.g. sulphuric acid, bleach, hydrogen peroxide, acetone, caustic soda) in the case of persistent stains.

Applied as an external thermal insulation system (ETICS) coating, fire classification according to EN:13501 B-S1-d0, consisting of Aluminium Starter Profile. Gluing of EPS/XPS. The sheets will be bonded with adhesive mortar, guaranteeing at all times 100% contact with the surface of the sheet. The pieces are mechanically anchored by nylon plugs with a steel screw and thermally insulated head. The layout and number of fixings will depend on the exposure of the building and its height, with a minimum of 4-5 pcs/m². Placement of corner profiles on edges as reinforcement, as well as in openings, fixed with mortar. Placement of water drip protection in areas of window openings. Installation of the frame

profile at the point where the insulation system meets the metalwork. Fitting of a proportional part of the reinforcing mesh in the corner of windows and doors.

The surface of the panels will be covered with a structural gluing reinforced with glass fibre mesh and anti-alkaline treatment and coated with mortar highly malleable and mechanical strength, mixed with glass fibre and rated R2 according to EN 1503-3. Application of Dekton® in a maximum format, to be defined according to the supplier of the ETICS/EIFS system, with resin based adhesive type R2 for Dekton® with mesh and cement based adhesive type C2S2 for Dekton without mesh.

Including, if indicated by the project's Operational Director, visible mechanical safety fixings screwed to the reinforced structural plaster.

Application Limits

Application limits of Dekton® on ETICS/EIFS System:

- Insulation type: EPS, XPS or mineral wool
- Maximum Dekton Slim Protek: 50x150 cm.
- Rendering System:
 1. Rendering Mortar: type R2 En 1503-3.
 2. Glass fibre net: 125 gr/m²
 3. Mechanical metal fixing anchors.
 4. Adhesive mortar (C2 E S2 or R2T EN 12004)
 5. Joint Mortar: CG2 EN 13888.
- Maximum building height: 20 m (6-7 floors)
- Reflection index of tiles: >20%.
- Maximum weight: Dekton + adhesive $< 25 \text{ kg/m}^2$

DKS Structure

DKS - Structure



General fixing instructions

1. Preparation of supporting wall.
2. Positioning of the starting profile.
3. Cutting and preparation of the insulation.
4. Placing the insulation on the wall.
5. Sanding of the entire surface.
6. Positioning of the fixings on the insulation panels.
7. Positioning of the rest of the profiles.
8. Resolution of the singular points.
9. Application of the mortar base and placement of the fibreglass mesh in the regularisation layer.
10. Positioning of the fixings on the fibreglass mesh.
11. Planning of the placement and expansion joints.
12. Placement of the Dekton® pieces.
13. Meeting of the placement joints.
14. Filling the expansion joints.
15. Removal and cleaning of excess material.
16. Final cleaning of the facade.

Fig. 1

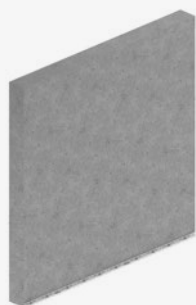

Fig. 2



Fig. 3



Fig. 4



Fig. 5



Fig. 6



Fig. 7



Fig. 8



Fig. 9



Processing & Installation

05

- 218 Shape Alterations
- 226 Cutting and Machining
- 228 Movement of Materials on Site
- 233 Adhesion
- 235 Processing
- 236 Cleaning and Maintenance
- 238 Contact Details



Shape Alterations

Although Cosentino can supply pieces to bespoke measurements, it is possible to cut them on site to deal with design changes, corners, pillars, etc.
 For pieces with internal corners a radius of at least 10mm should be used.
 Pieces will always include a minimal bevel.

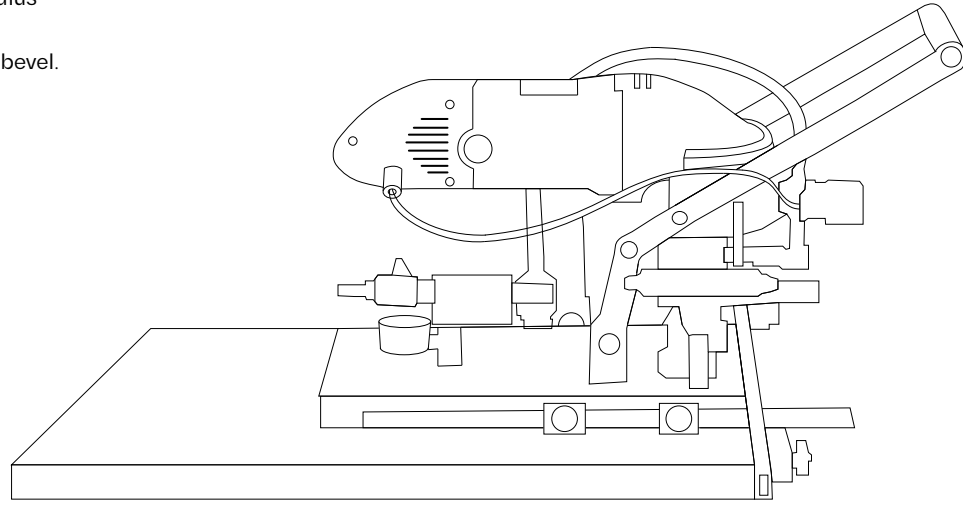

Generic Tools

Measuring tools

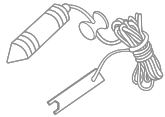

M01 Leveling system



M02 Tape measure

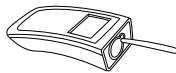

M04 Digital tape measure



M05 Laser measuring tool

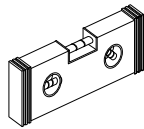

M06 Spirit level

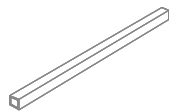

M07 Metal ruler



M03 Tape measure

Disc cutter

Ceramic blade 115mm & 125mm Rubi, Italdiamant, ADW, KGS

ADW Epic
Available in 115, 125 & 180 mm

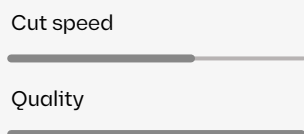
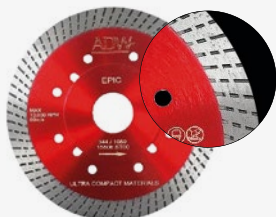

Italdiamant Continous RIM
Available in 125mm

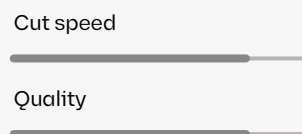
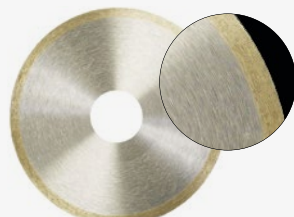

KGS Red K835
Available in 115 & 125 mm

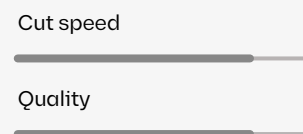

Recommended parameters

Diameter of the blade (mm)	115	125	180
Rotation speed* (rpm)	11,000-12,000	11,000-12,000	11,000-12,000

* The cut speed should be adjusted according to the type of machine and the thickness of the material.
A thicker piece will require a reduced speed.

Requirements my machine should meet



Cooling water flow focused on the cutting area



Well-leveled support base



Support for the larger part of the slab



Sharpen the diamond before every job



Blade depth 3 to 5 mm on the cutting bed

Cutting bits

Italdiamand EVOGRES
Available in one size



Cut speed

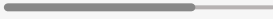

Quality

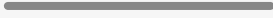

ADW
Available in one size



Cut speed

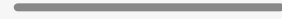

Quality

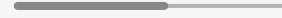

Dongsin M1
Available in one size



Cut speed

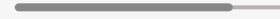

Quality

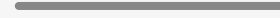

ADI Milling tool
Available in one size



Cut speed

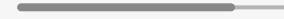

Quality

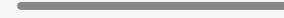

Recommended parameters

Thickness of the slab	8mm	12mm	20mm
Cut speed (mm)	200	190	180
Speed at the exit (mm/min)	70	70	70
Rotation speed (rpm)	4,500	4,500	4,500
Rotation speed milling tool (rpm)	60,000-75,000	60,000-75,000	60,000-75,000

Requirements my machine should meet



Cooling water flow focused on the cutting area



Well-leveled support base



Sharpen the diamond before every job



Support for the larger part of the slab

Specific Tools

Circular saw for wet or dry blade cutting

Rubi TC-125

- Precise cutting guide.
- Double dust reduction system: suction or wet system.
- Height-adjustable cutting head (plunge effect), hinged from 90° to 45°.



Raimondi Power Raizor

- Precise cutting guide.
- Double dust reduction system: suction or wet system.
- Adjustable cutting head for diverse cutting angles (45°, 90°, 180°).



Montolit Moto Flash Line dry cutter

- Precise cutting guide.
- Single dust reduction system: suction.



Makita SP6000

- Precise cutting guide.
- Single dust reduction system: suction.
- Height-adjustable cutting head (plunge effect), hinged from 90° to 45°.



Score and snap cutting technology

Rubi Slim cutter

- Guided straight cut.
- Progressive separation of the material, reducing the risk of breakage.



Montolit system for cutting

- Guided straight cut.
- Progressive separation of the material, reducing the risk of breakage.



Raimondi Raizor

- Guided straight cut.
- Progressive separation of the material, reducing the risk of breakage.



Drilling

Rubi DRYGRES diamond drill bits kit



DRYGRES 4DRILL diamond drill bits



Fixings Alterations

Portable machinery

Fischer Mobile Drilling Equipment BSN 100. DKT1



Fischer Mobile Drilling Equipment BSN 100. DKT1



Keil portable drill. DKT1



Maincer HFV ventilated façades tool. DKT2 & DKT3



Raimondi Rai-Cut. DKB



Handling Tools

RUBI - Slab Trans Heavy Duty

- 6 vacuum suction cups Ø20 cm
- Maximum piece size 320x180 cm
- Maximum load up to 140 kg



RAIMONDI - Easy move MK III with vacuum suction cups

- 6 vacuum suction cups Ø15 cm
- Maximum piece size 320x180 cm
- Maximum weight 260 kg



Cutting and Machining

At the Cosentino Factory all slabs can be cut and machined following project drawings and delivered to site in the desired order.

Please consult with the Project Service Unit department for special project requirements.

Undercut drill holes can be machined in the pieces following strict quality control according to the anchor manufacturer. The holes will be drilled according to the design of the façade, cut plane, and static calculations provided, or the calculations recommended by the Technical department.

Holes and grooves can be made following the project data and static calculations provided.

Please consult with our Technical Department for Cut to Size tolerances.

Anchors and hangers also can be installed to panels if ordered.

Undercut anchors (DKT1 System), screws, hooks and other materials can be provided by Cosentino if required. These anchors are supplied by a third party, so lead times and pricing may vary.

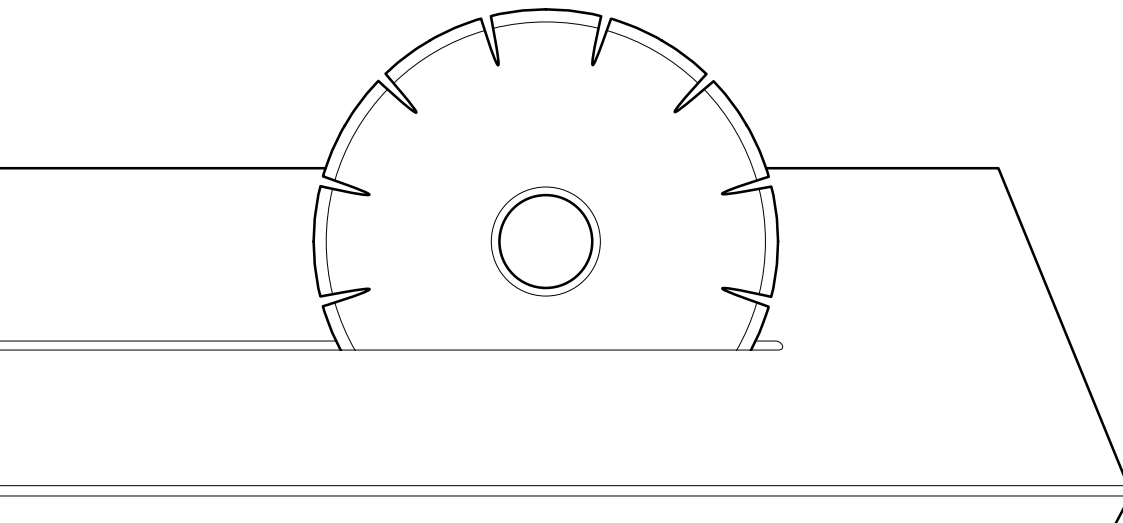

Quick guide to correct elaboration

Cutting tools

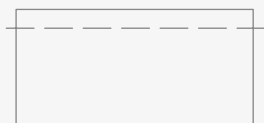

On-site correction
of measurements

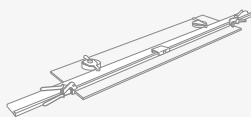

Dry cutting

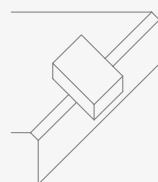

Microbevel 1mm

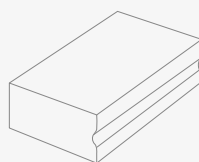

Polishing wedge

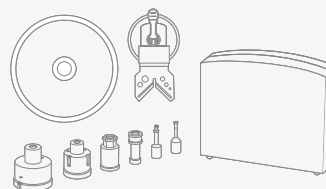

Certified blades and drill bits

Cutting on site

On-site cutting is possible using dry cutting machines.
We recommend the use of polishing
blocks to micro-bevel the pieces.

1st Holes

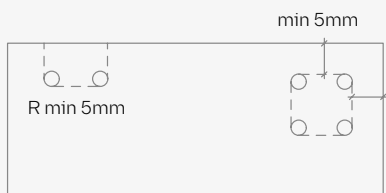

2nd Cuts



Movement of Materials on Site

Recommendations to be considered when moving Cosentino pieces:

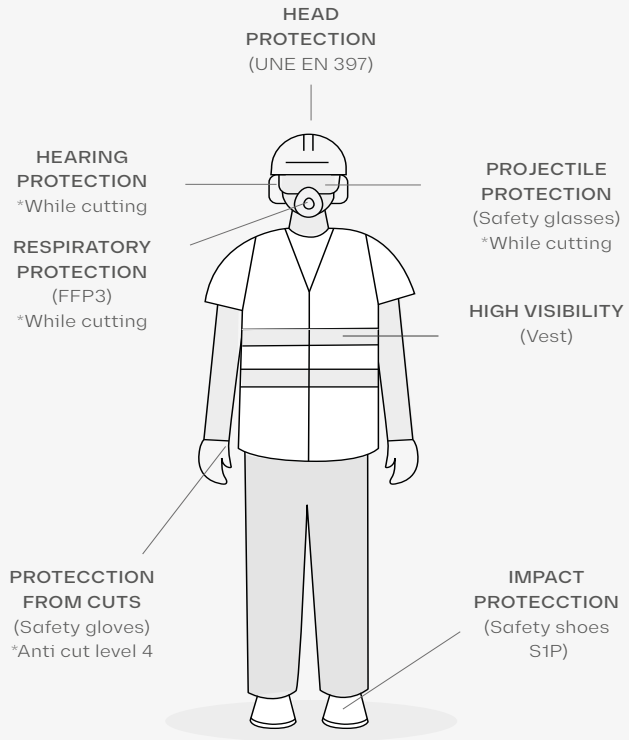

Additional PPE

Use of gloves and sleeves to ensure arm protection.



Receipt of material

- A good communication flow is recommended regarding incoming material logistics. There must be proper coordination between supplier, carrier and recipient of the goods. It is imperative to obtain delivery information showing the quantity, the date of arrival and the specifics of the material to be received in order to optimise the time on site of the different work teams.
- Always pay attention to the loading and unloading instructions found on the pallet wrapping. Unloading the pallet from the wrong position can significantly affect the integrity of the product.
- The incoming goods must be checked on site immediately after unloading. The points to be checked are the condition of the pallet, the number of packages and pieces, and the integrity of the pieces or slabs. In the case of an incident during the receipt of the material, a photographic report will be drawn up and Cosentino's project manager will be contacted immediately. Furthermore, whenever possible, the incident should be recorded on the delivery note.
- Knowing how and when the material will be received will facilitate the correct management of the unloading at the workplace, allowing the necessary auxiliary equipment to be prepared, storage location to be reserved and delivery notes to be correctly kept.
- It is recommended to check the packing list included in each package.

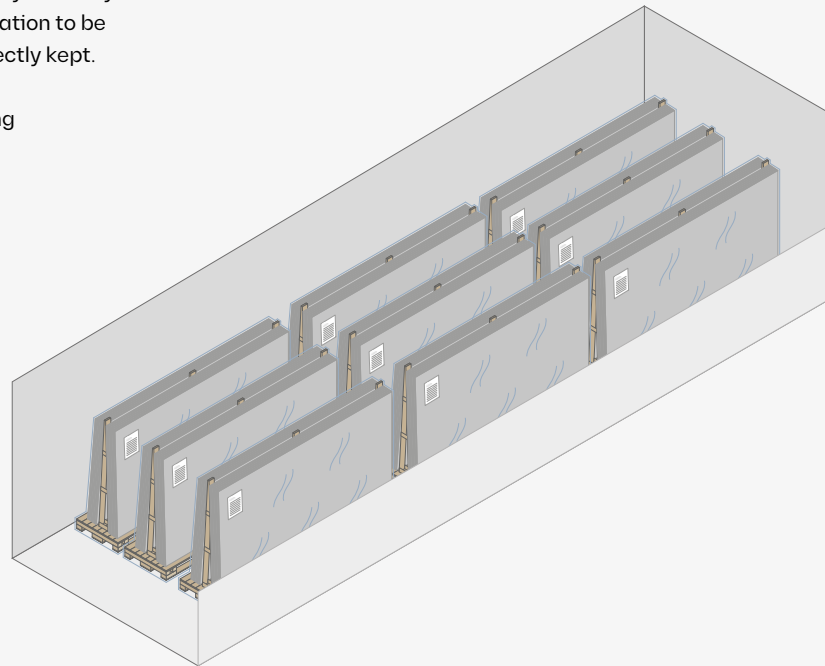
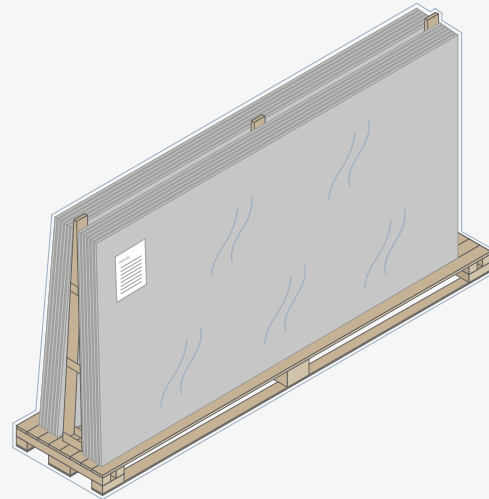

Storage

Assignment of the storage area arranged for the unloading and storage of Cosentino material. The area must be clean, level and delimited in a way that allows an efficient organization of the material. The area must be situated away from the transit area on site, in order to ensure the integrity of the product.

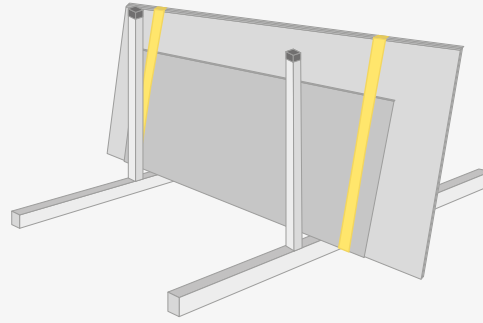

Different kinds of packaging according to project.

Recommended storage of the panels:
in a dry place, protected from rain.

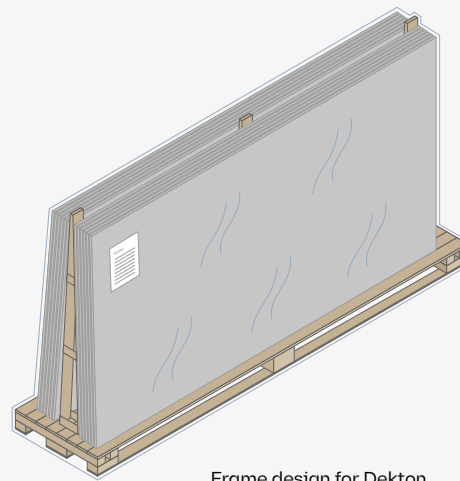

Frame design for Dekton

Package handling

The transport from the storage location to the installation site must be carried out by mechanical means (fork-lift truck, manitou, etc.). The package must be handled according to the instructions on the package.

It is essential that the staff operating cranes, auto cranes or fork-lifts are fully qualified and have received specific training for the task. It must be ensured that the staff in charge of these activities receive the guidelines provided by Cosentino regarding the handling of materials.



Movement of individual pieces

- Carefully open the pallets on site.
Procedure for opening pallets:
Remove the plastic wrap, then secure the pieces with clips and finally cut the plastic straps.
- It is recommended to have a jigsaw.
- Plan and arrange resting places at strategic points on the way between the material collection area and the installation area. It is recommended that these resting places be equipped with an element that ensures cushioning, such as a piece of wood or compressed foam, and a vertical support so that both the piece and the workers can rest before the next section or movement.
- Manual handling is limited to 25kg per person. At least two people are required to handle pieces over 25 kg, with four being the recommended number for handling standard, large-format pieces. If the dimensions of the pieces do not allow for easy handling by four people, it is recommended to use manual suction cups or a carrying frame with multi suction cups in order to facilitate the grip and distribution of weights along the slab.
- It is recommended to use mechanical means for the transport of pieces, avoiding as much as possible moving the pieces manually. Some examples of mechanical means are tackles, glass lifting tools, etc.
- For individual movement of pieces, and depending on the size of the piece, we can recommend 2 types of tools:
 1. A glass lifting tool for individual movement. It is characterized by a cushioned, grip surface greater than 80cm. This type of tool can usually be found in the glass sector. For example: TECNOCAT P21 – load 800kg – for pieces longer than 250cm.
 2. Double-lip vacuum suction cups, which provide a grip for the roughest surfaces, can also be used. At least 2 suction cups must be used when moving the piece in teams of two people, and up to 4 suction cups in order to facilitate vertical transport.
- The movement of the slabs will be carried out vertically to avoid the bending and twisting of the material, and therefore guarantee its integrity.

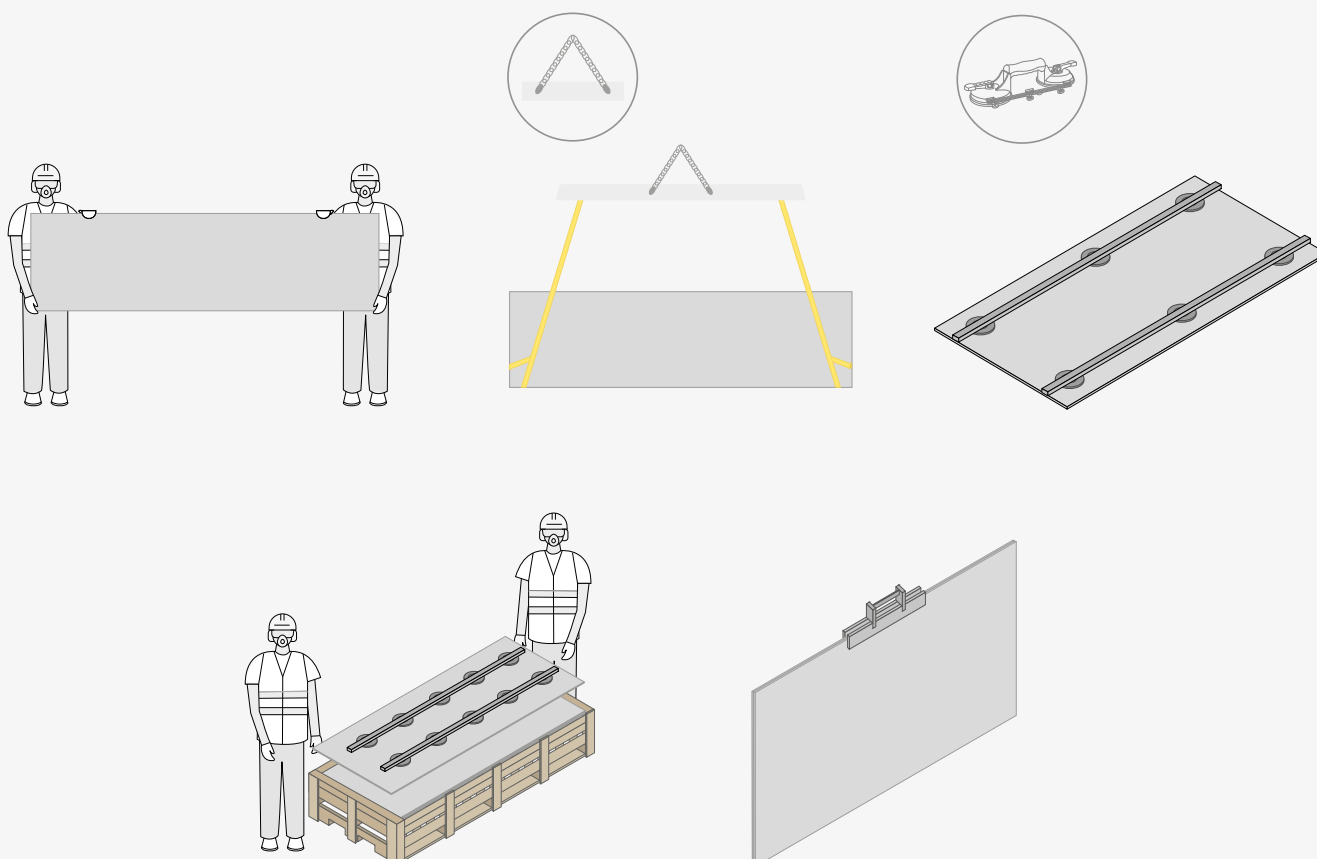

Scaffolding

There are different types of scaffolding on the market and any can be used depending on the project size, the work to be done and the size of the parts to be fitted:

- Mast climbing work platforms: ideal for large-format pieces and where loading is carried out on the same platform, always in compliance with the loading limitations according to the manufacturer's specific instructions. The length of the platforms can be up to 30 metres. It is the scaffolding system most used by Cosentino's customers due to its versatility and speed of assembly.
- Supported scaffolding with platforms for unloading material. This type of scaffolding is ideal for façades with small cuts.
- Suspended scaffolding. They are used for small jobs, such as replacement or maintenance work, as the maximum load they can carry is very small and restrictive. This type of scaffolding is mainly used in small renovations or on replacements.

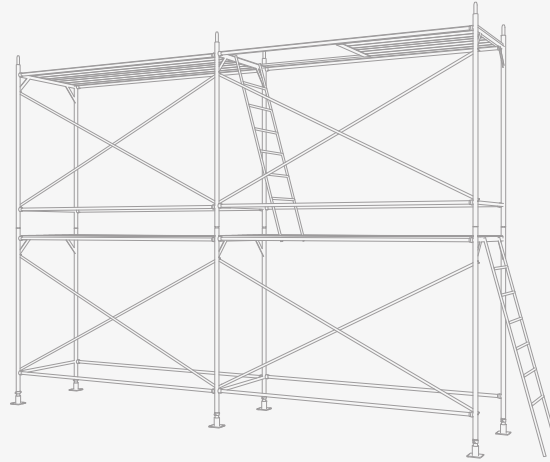

Scissor lift

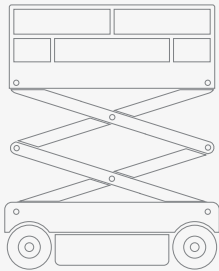

Crane arm with platform

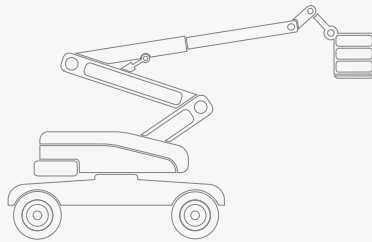

Adhesion

Chemical anchoring

When installing Dekton on a ventilated facade, it is important to follow a series of instructions:

- The profile on which it is to be glued must always be in a vertical position, suitably plumbed and free of tension.
- A panel must be fixed to at least two vertical profiles. Depending on the size of the panel and the conditions of the project, the number of profiles needed to fix the panel will be defined.
- Precise positioning of the panel on the vertical profile of the facade is important.
- The application temperature of the adhesive system must be respected (it is usually between +5°C/+35°C (40-95°F)).
- Adhesive systems must be complete and supplied by a single manufacturer in accordance with his technical application instructions.

They are usually applied, in a general way, in the following steps:

1. Profile Treatment and Dekton Treatment.

Both the profile and the Dekton surface must be clean, dry and free of dust, grease and oil. Primers, adhesion promoters and cleaners specified by the adhesive system supplier should be used.

2. Application of double-sided tape.

The tape must be applied along the entire length of the profile in a parallel manner, always vertically and without removing the protective film once it has been attached to the profile.

3. Application of the adhesive.

The adhesive is applied in the form of a vertical triangular line using the pre-cut nozzle indicated by the supplier. The height, width and distance from the adhesive to the tape is indicated by the supplier. The width of the profile must be sufficient to respect all distances to the edge and between components.

4. Placement of the panel.

The protective film is removed from the double-sided tape. Position the panel as indicated by the design, without touching the tape and then press it until it touches the tape. The panel should be set within the maximum time indicated by the adhesive supplier (e.g. 10 minutes). Spacers may be required to mark the joint between panels.

General observations on application, execution and control of work

- Do not prime or bond in when there is rain or high moisture content (e.g. heavy fog).
- Avoid risk of condensation on profiles and panels. Profile temperature should be above dew point.
- Follow the recommended application temperatures, drying times and application of each component.
- We recommend having a daily control of the work with information about the installed panels, weather conditions, construction solutions, system used (components).
- It is recommended that the installation be completed by companies that have had proper training on this type of system. For a list of these companies, please contact Cosentino.

Manufacturers of chemical anchorings tested with Dekton:

- Sika. Sika Tack Panel 50.
- Innotec. Innotec bonding system (Adheseal adhesive)
- Bostik. Panel Tack HM
- Soltec. Soltec Panel Fix.
- Louvelia. Louvelia Fix

Each manufacturer has its own technical documentation, including component data sheets, safety data sheets, adapted fixing instructions, system certifications and/or tests... etc.

Safety recommendations for chemical anchoring

There is the possibility, if indicated in the project, of incorporating mechanical safety fasteners for 8 mm parts.

These elements are fixed to the profile system and their arrangement and fixing must follow the supplier's instructions.

Processing

Normally, slabs are delivered cut and drilled from the factory following the project design.

Available mechanical operations for facades

DKT1. Undercut drill

TK (thickness = 8/12 and 20 mm)

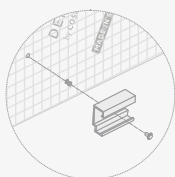

DKT2. Continuous grooved edge

Width 3/4 mm. (thickness = 12 and 20 mm.)

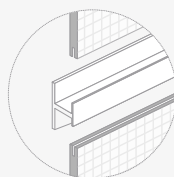

CR2. 1. (thick. 12mm, width 3mm, depth 10mm.)
 CR2. 2. (thick. 20mm, width 3mm, depth 10mm.)
 CR2. 3. (thick. 12mm, width 4mm, depth 10mm.)
 CR2. 4. (thick. 20mm, width 4mm, depth 10mm.)

DKT3. Intermittent grooved edge

Width 3/4 mm. (thickness = 12 and 20 mm.)

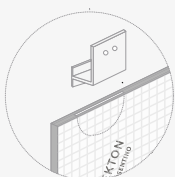

DKBG. Rear groove continuous or spot

CR4 (thickness = 8 and 12 mm)

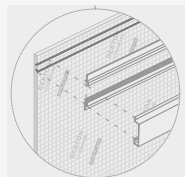

Continuous groove

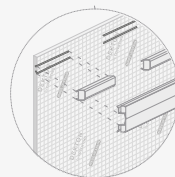

Spot groove

DKB. Intermittent groove on the reverse

CR5 (thickness = 8 and 12 mm)



Intermittent hole on the edge

T1 (thickness = 12 and 20 mm)

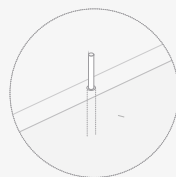

- Dekton® machining dimensions may vary depending on the specific conditions of each project.
- The thickness of the material will depend on the systems used and the requirements of the project.
- Cosentino is not responsible for mechanical calculations, nor does it indicate the necessary holes and grooves per m².
- The pieces intended for a ventilated façade will incorporate a mesh on the back of it.
- This mesh is available on request (minimum order to set up a complete slab).
- In some references, both the orientation of the texture/decoration and the background movement must be taken into account.

The following items are included in the quotation for facade projects at no additional cost:

1. NON-RETURNABLE PACKAGING
2. TRANSPORT TO DELIVERY POINT.
3. SAFETY MESHING (for Dekton® 4 mm and Dekton® ventilated facade).
4. REFERENCED PALLETIZING (following project plans).
5. CUTTING OPTIMISATION (Project Modulation)

Cleaning and Maintenance

Dekton® has practically zero porosity, so is easy to clean. Rainfall is effective to remove any accumulated dirt and to keep the external cladding clean.

But the dirt and soil depends largely on the local atmospheric conditions depending on the location of the project. In heavily industrialized areas, coastal areas and the areas where construction works are being carried out, it might be necessary to clean the product occasionally or on a periodic basis, solely for the purpose of aesthetic appearance.

If Dekton® cleaning is required, the schedule might be adjusted with other cleaning operations of the external facade for example, glass and painted aluminium components.

If an automatic wall cleaning machine is to be used, a pre-test should be done in the early stage of equipment design to confirm that there is no detrimental effect on the panel as well as to clarify the cleaning effect and frequency.

Final Cleaning On Site

After the installation of Dekton®, the surface usually shows remains of work, in the form of film or small accumulations of cement, lime, epoxy, etc. Therefore, it is necessary to do a final cleaning job to ensure total cleanliness of the Dekton.

Cleaning protocol:

A) Prepare the cleaning products and tools

- Descaling detergent. (Acid-based buffer)
- Epoxy remover cleaning product
- High-pressure washer
- Brush or scourer and sponge can be used if a high-pressure washer is not available

B) Procedure

- Mix the acid product and water (according to the manufacturer's instructions)
- Spread the mix on the facade and leave it for few minutes (according to the manufacturer's instructions)
- Clean with a high-pressure washer; if you do not have a high-pressure washer, it is recommended to scrub with a brush and rinse with a damp sponge.

Cleaning and Maintenance

Maintenance has the important purpose of removing dirt superficially embedded. Correct maintenance guarantees a natural appearance of the facade.

The site should be inspected on a six monthly or yearly basis, depending upon the atmospheric conditions where the project is located as defined above.

For cleaning, it is recommended to use a neutral detergent with high cleaning power, avoiding products with too much soap or presence of wax.

The simplest procedure for cleaning is to spread the solution, following the manufacturer's instructions, wait a few minutes and clear out with a high pressure washer; without the high-pressure washer, it is recommended to scrub with a brush and rinse with a damp sponge.

Stubborn Stains

For stubborn stains, those which have been there for a while, or of a special composition, that are stuck to the surface and cannot be removed with daily cleaning, we recommend following the table below.

STAIN	CLEANING PRODUCT
Liquids and organic residues	Conventional detergent, grease remover
Grease and oil	Degreaser
Rubber	Degreaser
Resins, putties, silicone, dyes	Solvent, Acetone
Traces of cement adhesives	Acid
Plaster	Plaster remover, Acid detergent
Tar	Degreaser
Nicotine	Abrasive cleaning product, Solvent, Acetone
Metal Rust	Metal cleaner, hydrochloric acid

* Avoid contact of Dekton® with hydrofluoric acid.

Contact Details

We have a presence
all over the world in
order to be close
to our clients and
their projects

Our Cosentino CITIES, located in some of the world's most iconic cities, create spaces where everyone can discover Dekton® and the latest market trends with all five senses. As well as being used as an office, these spaces can be set up for meetings, classes, exhibitions, and much more. We see them as dynamic, social spaces and the ideal setting for exchanging ideas.

Wherever they are in the world, our Cosentino CENTERS are the epicentre of our company. Anyone with a curiosity or passion for design is welcome to visit our warehouses to experience our life-size products close-up and to see them in use. We know all there is to know about Dekton®'s rich colour variety and what it brings to the world of design.

• COSENTINO CITY

UNITED STATES

Cosentino ANAHEIM
Cosentino ATLANTA
Cosentino AUSTIN
Cosentino BOSTON
Cosentino CHARLOTTE
Cosentino CHICAGO
Cosentino CINCINNATI
Cosentino DALLAS
Cosentino DENVER
Cosentino DETROIT
Cosentino FORT LAUDERDALE
Cosentino HAWAII
Cosentino HOUSTON
Cosentino KANSAS CITY
Cosentino LONG ISLAND
Cosentino LOS ANGELES
Cosentino MILWAUKEE
Cosentino MINNEAPOLIS
Cosentino NASHVILLE
Cosentino NEW JERSEY
Cosentino NEW ORLEANS
Cosentino ORLANDO
Cosentino PHILADELPHIA
Cosentino PHOENIX
Cosentino PITTSBURG
Cosentino PORTLAND
Cosentino RALEIGH
Cosentino ROCHESTER
Cosentino SACRAMENTO
Cosentino ST. LOUIS
Cosentino SALT LAKE CITY
Cosentino SAN DIEGO

Cosentino SAN FRANCISCO
Cosentino SEATTLE
Cosentino SPOKANE
Cosentino TAMPA
Cosentino VIRGINIA
Cosentino WASHINGTON DC
[Cosentino CITY LOS ANGELES](#)
[Cosentino CITY MANHATTAN](#)
[Cosentino CITY MIAMI](#)
[Cosentino CITY SAN FRANCISCO](#)
Cosentino HUB HOUSTON
Cosentino HUB NORFOLK

CANADA

Cosentino CALGARY
Cosentino QUEBEC
Cosentino TORONTO
Cosentino VANCOUVER
[Cosentino CITY MONTREAL](#)
[Cosentino CITY TORONTO](#)

MEXICO

Cosentino MEXICO DF

PUERTO RICO

Cosentino LO PUERTO RICO

SPAIN

Cosentino A CORUÑA
Cosentino ALMERÍA
Cosentino BARCELONA
Cosentino BILBAO
Cosentino CASTELLÓN

Cosentino GIRONA
Cosentino GRANADA
Cosentino MADRID
Cosentino MÉRIDA
Cosentino MURCIA
Cosentino SAN SEBASTIAN
Cosentino SANTANDER
Cosentino SEVILLA
Cosentino TOLEDO
Cosentino VALENCIA
Cosentino VALLADOLID
Cosentino VIGO
[Cosentino CITY MADRID](#)

PORTUGAL

Cosentino LISBOA
Cosentino PORTO

BRAZIL

Cosentino FORTALEZA
Cosentino GOIÂNIA
Cosentino LATINA VITORIA
Cosentino RECIFE
Cosentino SANTA CATARINA
Cosentino SAO PAULO IRELAND
Cosentino DUBLIN

UNITED KINGDOM

Cosentino BELFAST
Cosentino DARLINGTON
Cosentino EAST LONDON
Cosentino GLOUCESTER
Cosentino HOOK



Cosentino MANCHESTER
 Cosentino NEWMARKET
 Cosentino SCOTLAND
 Cosentino CITY LONDON

DENMARK
 Cosentino DENMARK

FINLAND
 Cosentino HELSINKI

GERMANY
 Cosentino BERLIN
 Cosentino DÜSSELDORF
 Cosentino MÜNCHEN
 Cosentino STUTTGART

ITALY
 Cosentino CATTOLICA
 Cosentino LAZIO
 Cosentino MILANO
 Cosentino TORINO
 Cosentino TURIN
 Cosentino VENEZIA
 Cosentino CITY MILAN

FRANCE
 Cosentino LYON
 Cosentino MARSEILLE
 Cosentino PARIS
 Cosentino RENNES
 Cosentino STRASBOURG
 Cosentino TOULOUSE

AUSTRIA
 Cosentino WIEN

BELGIUM
 Cosentino BELGIUM

NORWAY
 Cosentino OSLO

SWEDEN
 Cosentino GÖTEBORG
 Cosentino STOCKHOLM

SWITZERLAND
 Cosentino ZÜRICH

NETHERLANDS
 Cosentino THE NETHERLANDS

ISRAEL
 Cosentino CAESAREA
 Cosentino TEL AVIV

TURKEY
 Cosentino ANKARA
 Cosentino ISTANBUL
 Cosentino IZMIR

SINGAPORE
 Cosentino SINGAPORE
 Cosentino CITY SINGAPORE

AUSTRALIA
 Cosentino ADELAIDE
 Cosentino BRISBANE
 Cosentino MELBOURNE NORTH
 Cosentino MELBOURNE SOUTH
 Cosentino PERTH
 Cosentino SYDNEY
 Cosentino CITY SYDNEY
 Cosentino HUB SYDNEY

NEW ZEALAND
 Cosentino AUCKLAND
 Cosentino LO CHRISTCHURCH
JAPAN
 Cosentino LO TOKYO

SOUTH AFRICA
 Cosentino JOHANNESBURG
 Cosentino LO CAPE TOWN

UAE
 Cosentino LO DUBAI
 Cosentino CITY DUBAI

POLAND
 Cosentino WARSAW

MALAYSIA
 Cosentino CITY KUALA LUMPUR

Project Quotation

06

- 242 PSU Technical Services
- 245 Integral Services for International Projects
- 250 Dekton® Warranty



PSU Technical Services

Services offered from the PSU (Project Service Unit) to facade projects are grouped in four different categories.

Basic project/technical advice

- Network of associated installers
- Specific test for for each project
- Providers of associated systems

Project implementation/Technical proposal

- Study of customised projects
- Quotation
- Technical drawings
- Project rendering
- Project delivery customisation

Project support on site

- Installation support on site
- Final visit on site
- After sales quality service
- Training at the factory. Theoretical and Practical
- Virtual visit to Facades Showroom (Facades Lab)

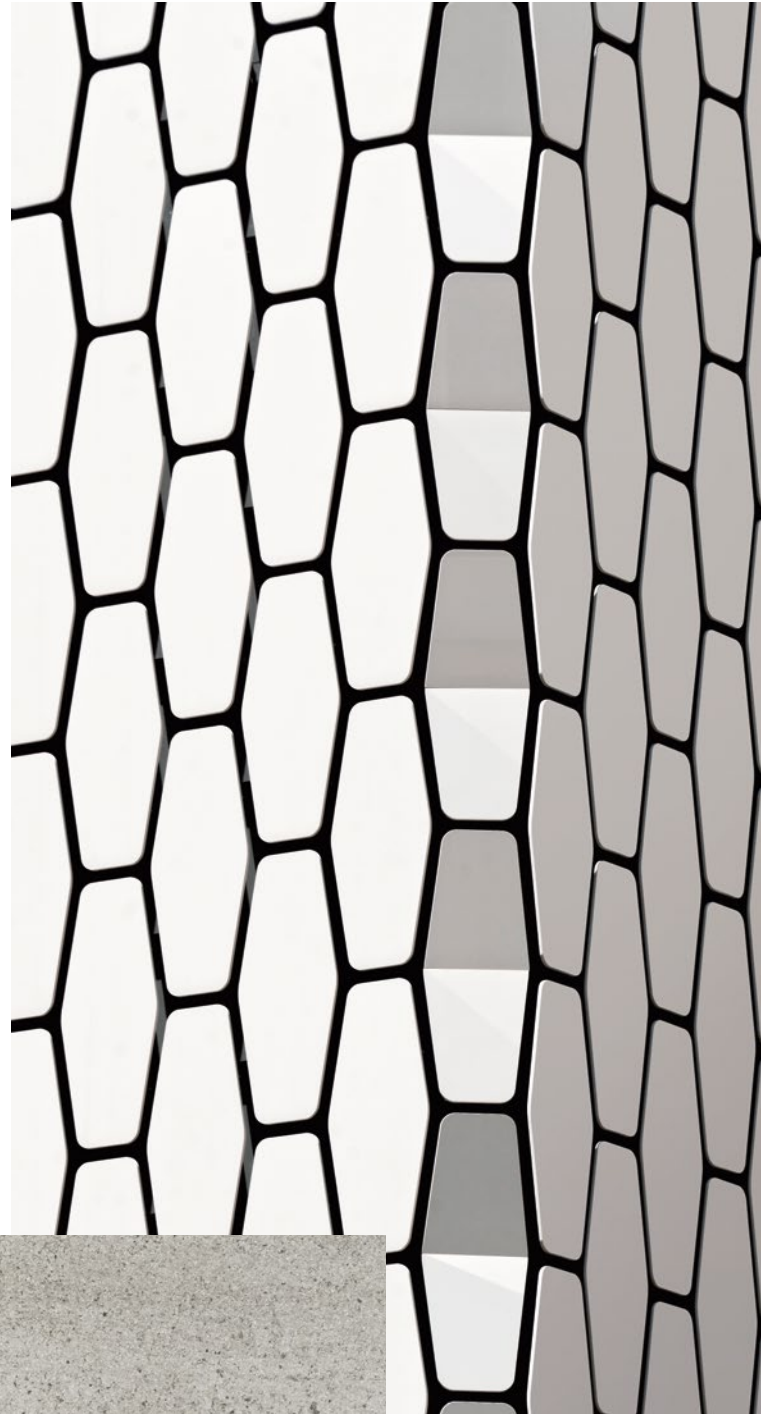

Project definition

Basic project/technical advice

- Initial meeting with facade specialist from salesforce
- Material definition: Colour, Thickness (Dekton iD services)
- Recommended optional systems
- Standards and certifications applied
- Performance and design optimisation
- Initial quotation
- References from previous facades (Case Studies)
- Cosentino City visit
- Virtual visits to the factory.
- Facade models in Augmented Reality
- Facade videos
- Factory visit (depending on the project)

Customised Projects

Project implementation/Technical proposal.

- Tender quotation and project description
- Constructive Solutions support
- Fixing distances for Dekton (software including Dekton FEM)
- Technical support for tests and testing
- 3D Rendering Model (depending on project)
- Collaboration with system suppliers (together with suppliers, facade consultants and technical installation office)
- Static calculation
- Workshop plans
- Final Quotation (including installation)

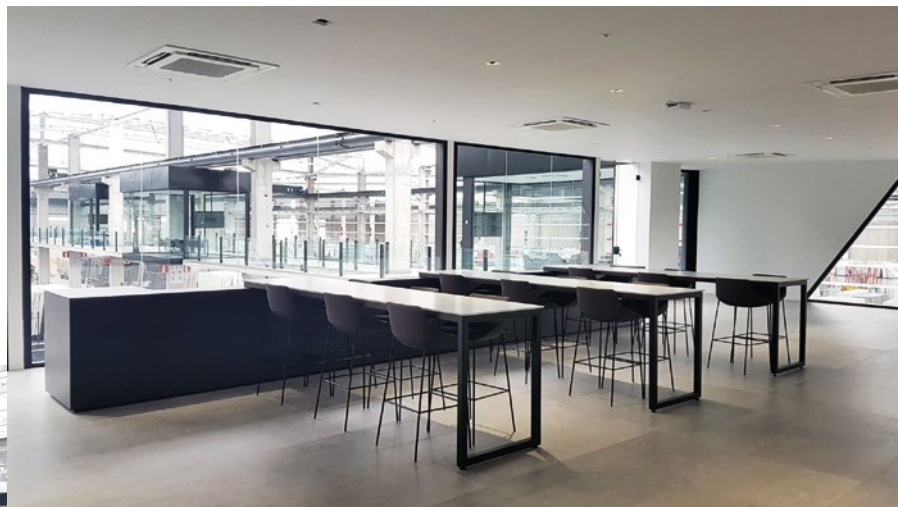

Integral installation support service

Project support on site.

CONTRACTOR

- Associated installer program
- Mock-up service on site
- Technical Support at on site meetings

INSTALLER

- Cut to size panels
- Panel machining
- Special 3D elements (U & L shapes)
- Personalised supply
- Closed service time
- On site support visits



Aftersales service

- Final on site visit
- Warranty delivery
- Project Case Study if needed e.g. Professional photos, videos, social media presentation....

Integral Services for International Projects

At Cosentino Group, we meet the demands of architects and designers who seek inspiration and information to execute construction and renovation projects. Every project entrusted to us through our sales and service network goes through several stages that guarantee efficiency and safety:



Initial Consultation

A Project Manager takes care of managing more than 15 analysis and implementation experts.



Production

We create turnkey projects and offer solutions for each of the phases in a personalised manner.



Logistics

A team of more than 170 people send the material via an automated platform.



Quotes and Technical Proposal

Detailed study of each element of your project.



Mock-ups and Layouts

Upon request, customers can be sent life-size samples of their project.



Quality Control



Implementation and Support

We advise customers in the project implementation as well as technical support.



Dekton Warranty

Transportation insurance to guarantee the perfect condition of our shipment.

Initial Consultation

We assess project requirements in detail and we advise on the use of one or various brands (Silestone, Dekton, Sensa or Scalea), depending on its characteristics and the application type: worktops, facades, cladding or flooring.

A Project Manager takes care of managing more than 15 analysis and implementation experts. Legal consultations are carried out on construction permits, certificates are arranged and software is used to prepare and manage plans.



Initial advice, analysis and technical proposal

DETAILED STUDY OF ALL PARTS OF YOUR PROJECT

- Assignment of a project manager
- A team of more than 15 experts (experienced architects, engineers, etc.) involved in the analysis and execution of the project
- Software for management and interpretation of blueprints
- A team of designers
- Different teams look at the study
- Advice on construction regulations
- A chance to obtain certificates
- Advice and solutions for LEED certification

QUOTATION AND TECHNICAL PROPOSAL

- A study of customer proposals and input of new ideas by our team of experts
- Design recalculations: Less Waste = Higher savings/Improved aesthetic finish
- A detailed budget for items
- Speedy budget implementation <48h
- Completion of specific certificates or tests for the project
- Coordination in security documentation

Production

At Cosentino, we can adapt to satisfy the needs and preferences of each architectural, decoration or design professional, thereby creating turnkey projects and providing solutions for each of the phases in a personalised manner.

More than 140 employees work in the production factory, using next-generation cutting and polishing technology. In the factory, they operate one automatic production line for worktops and another for sinks, an automatic stone washing machine, and a texturing machine.

Over 187 employees work in the flooring and cladding factory, with one automatic line that creates large slabs measuring from 600 x 600 mm up to 3,200 x 1,500 mm, and another automatic line for pieces measuring from 300 x 150 mm up to a maximum of the size of the slab itself (3,200 x 1,500 mm). Furthermore, more than 140 people work in quality control with raw materials.



Logistics

The material produced is packaged with the aim of limiting the weight and dimensions per package and taking into account the agreed design for the piece placement order.

Every day, a team of more than 170 people send the material via an automated platform that is adapted to the customer's requirements in terms of time and volume.

At Cosentino, we have signed delivery contracts with the main shipping companies and can accommodate more than 150 containers at our own facilities.

Quotes and technical proposal

A budget is drawn up for each part of the project based on the initial proposal, any changes suggested by the experts, any new designs and the inclusion of customised colours.

Design and development

An R&D + Innovation team together with our internal designers, work in direct contact with the customer through our CustomColour Product Manager.

Mock-ups and Layouts

We create 3D digital models to present the final image of the project, as well as mock-ups or physical prototypes. Upon request, customers can be sent life-size samples of the brands to be used in the construction process.

We offer the possibility of preparing a mock-up to be able to validate structures and modulated systems in advance.



Possibility of the final project aspect in 3D Digital

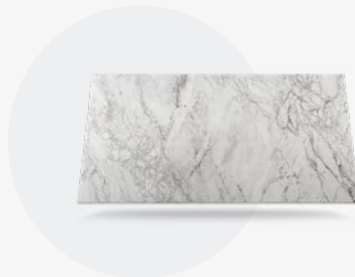

We ship actual size samples

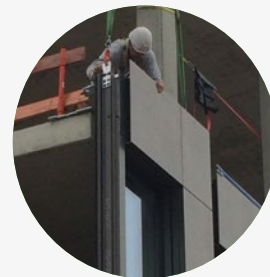

Possibility of on-site mock-up

Implementation and Support

A budget is drawn up for each part of the project based on the initial proposal, any changes suggested by the experts, any new designs and the inclusion of customised colours.

Project management and execution.

1

Production

Guaranteed deadlines thanks to the link between the Project and Factory through our Project Manager.

Daily review of production date plans adjusting to work setbacks.

Production factory: More than 140 workers.
Max capacity of 240,000 m² CTS a month.

Project Factory. Facades, flooring and cladding.
Max. capacity of 150,000 m² month.

3

Packing

Customised packaging. We pack all our materials treating each piece as an individual unit, adding specific protection in each case.

Vertical or horizontal design possibilities.

Choice of other specific materials
- ECO Packaging.

Organisation by lots, items and size.

Information sheets (safety, material, use, maintenance, etc.)

5

Post-sales

Incident management and resolution.
Cosentino's specialised staff can travel for 'on-site' assessment and resolution.

Transportation insurance to guarantee the perfect condition of our shipment.

Monitoring and traceability of all shipments to their destination.

Training in the use and maintenance of the material in each application.

2

Quality control

Validation of production plans by the customer as well as the final product before loading and shipping.

Each piece of the finished product is individually checked by our quality team.

Support when receiving the material/piece from our Technicians, according to the project

4

Logistics

We manage the goods efficiently from point to point for the customer thanks to a Logistics and Planning team of more than 170 people.

More than 40 Containers and 20 trucks per day.

Preferential agreements with the world's leading shipping companies.

Dry port in our facilities with capacity for more than 150 containers.

Agility in customs and ports.

Dekton® Warranty

Cosentino has a specific team from the Quality Department, trained to provide on-site support. In addition, we have our Dekton® Trainers. Their mission is to provide training and the certification of workshops for the proper preparation of materials.

Cosentino offers a 10-year material guarantee on its Dekton® façades executed anywhere in the world and offers its clients, if necessary, all its support and project monitoring services so that they are executed according to the highest quality standards.



WARRANTY
FACADES



COSENTINO®

Ctra. Baza a Huércal-Overa, km 59 / 04850
Cantoria - Almería (Spain) / Tel.: +34 950 444 175
info@cosentino.com / www.cosentino.com



* To obtain more information about colours with an NSF certificate please visit www.nsf.org

Rev: 02 06/2021