



INTERIOR DOORS

BROCHURE



(2) 15 Lite True Divided
Primed French Door
Finished in Field

DOOR TYPES

Flush Doors

Common, inexpensive and easy to paint or stain, flush doors are stocked in Primed Hardboard, Red Oak, Birch, and Imperial Oak. They are available in hollow or solid core, unfinished or prefinished, and have optional lites and louvers. Special order species are also available

Molded Doors

Molded door skins are made by combining fine wood fibers and resins and then "stamped" into a variety of raised panel designs. Their popularity is due to their value – you get a great looking door for a great price. Molded doors are available in smooth or woodgrain, hollow or solid core and represent one of the best "bang for your buck value" in the industry.

Did I Choose the Right Door?

It really comes down to your taste and budget.

Fortunately, MMI DOOR inventories a huge selection for any budget that is available to you within 7-10 days!

If you have more time, our extensive special order options are available to you within 3-6 weeks.

MDF Doors Medium Density Fiberboard

MDF doors are an affordable step up from solid molded doors. They offer a smoother, denser skin (MDF) that results in a higher quality finished product when painted. Most MDF doors are solid core. Design and sizing possibilities are endless in this category which adds to its popularity.

Panel Doors Raised Panel, Flat Panel & French

Multiple designs, species and glass options define the top end of the interior door category. Though some wood species can be painted, the majority are stained to showcase their attractive wood grains.

Available in-stock species include Pine and Oak

TABLE OF CONTENTS

CHOOSE YOUR DOOR	1-2
HOLLOW & SOLID CORE MOLDED DOORS	3-6
FRENCH DOORS	7-8
PRIMED SHAKER FLAT PANEL DOORS	9
PANEL AND LOUVER DOORS	10
FLUSH & PREFINISHED DOORS	11
LITES & LOUVERS	12
7/0 BARN DOORS	13
WALL-MOUNTED BARN DOOR HARDWARE KITS	14
THE MILLENNIUM COLLECTION	15-16
FIRE-RATED DOORS	17-18
COMMERCIAL DOORS & HARDWARE	19
SLIDING DOOR POCKETS & HARDWARE	20
OPTIONS	21
SPECIAL ORDER GLASS	22
SPECIFICATIONS	23
CARE, FINISHING & WARRANTIES	24



Impressions Mirror
Molded Door
Finished in Field

THOUSANDS OF DOOR OPTIONS
RIGHT AT YOUR FINGERTIPS!

DOWNLOAD • SNAP • SHARE



GET THE **FREE**
MOBILE APP
TODAY!

Available for all Apple and Android devices.



CHOOSE YOUR DOOR

7 EASY STEPS TO CHOOSE YOUR NEW INTERIOR DOOR

Interior doors have become an intricate part of home design and adding or upgrading the doors in your home can increase your home's value. This has raised the interest for more options, functionality and an improved quality of life. With all the options on the market today, choosing an interior door can be an intimidating process.

MMI DOOR has developed a step-by-step system below to help guide you in the right direction.

1 Functionality

This is a critical planning stage, use it wisely. Every opening doesn't require the same door.

- Examples:
- A) French doors (single or double) can provide light to an adjoining room while maintaining privacy
 - B) Solid core doors look the same on the outside but contain sound reducing material on the inside. Great for bathrooms, game rooms, music rooms, bedrooms, offices, etc.
 - C) Mirrored doors on a bedroom closet or bathroom door saves space, enlarges the room and creates additional reflective light
 - D) Doors with frosted glass provide extra light without sacrificing privacy
 - E) Barn doors combine style and practicality while transforming your space to complement the modern home

2 Choose a Door Design

Flush contemporary, traditional colonial or something totally unique? The choices are immense. This is your home - Make it your own!



CHOOSE YOUR DOOR

3

Are You Painting or Staining?

This decision will narrow your choices:

Consumer Tips:

- A. Painting is quicker, less expensive and easy to change. Staining is the opposite but will produce dramatic results.
- B. If painting – Primed Panel, Molded and MDF doors are your choice. If staining – Wood Panel or Flush doors are your choice.
- C. Don't be afraid to paint the door and stain the trim or vice versa. It's happening everyday!

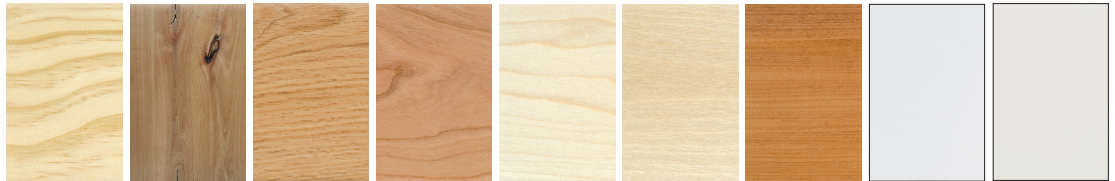

Pine Knotty Alder Red Oak Cherry Maple Birch Mahogany MDF Primed

4

Choose Your Door Jamb

Consumer Tips:

- A. If painting – choose primed.
- B. If staining – select the same species with a grain that either matches or most closely matches your door as related on page 21. We have a variety of jamb species to accentuate your door. Get the wow factor going. Don't be afraid to finish the door and trim differently. See examples throughout this brochure.

5

Choose Your Hinges

Hinges are a decorative item too! Match the hinge finish with the overall hardware theme of your home. This includes locks, light fixtures and decorative accents. Upgrade to Ball Bearing Hinges for added durability. These hinges are engineered for the smoothest and quietest door operation. Available on solid core doors only.

Round Ball Bearing Hinges



US-3/4 Lite Brass US-5 Antique Brass US-3 Bright Brass US-26 Bright Chrome US-26D Dull Chrome LUS-15 Dull Nickel US-15A Antique Nickel US-10BD Colonial Bronze - Dark US-19 Flat Black US-P White Primed

Square Ball Bearing Hinges



US-3 Bright Brass US-10BD Colonial Bronze - Dark

Self-Closing Hinges



US-15 Satin Nickel

6

Sizing

Confirm the size of every opening – width and height. This includes the door as well as the “wall width” of the jamb.

7

Place Your Order!

Please Note: Availability varies by location.



6 Panel
Pine Panel Door
Finished in Field

HOLLOW & SOLID CORE MOLDED DOORS

MOLDED DOORS

When you want plenty of options, select interior molded wood fiber doors. These doors are created in several styles, panel designs and sizes.

Single and double doors can be ordered as ready-to-install prehung units in a wide variety of sizes, jamb species and decorative hinge finishes.

AVAILABLE 6/8, 7/0, & 8/0 MOLDED DOOR SIZES																
DOOR MODEL	1'0"	1'2"	1'3"	1'4"	1'6"	1'8"	1'10"	2'0"	2'2"	2'4"	2'6"	2'8"	2'10"	3'0"	STICKING PROFILE	BI-FOLDS
BIRKDALE																
6'8" Hollow Core				•	•	•		•		•	•	•	•	•	Craftsman	•
6'8" Solid Core					•			•		•	•	•	•	•	Craftsman	
CAIMAN																
6'8" Hollow Core				•	•	•	•	•	•	•	•	•	•	•	Cove & Bead	•
6'8" Solid Core				•	•	•		•	•	•	•	•	•	•	Cove & Bead	
8'0" Hollow & Solid Core					•			•		•	•	•	•	•	Cove & Bead	
CAMDEN																
6'8" Hollow Core				•	•	•	•	•	•	•	•	•	•	•	Cove & Bead	•
6'8" Solid Core					•			•		•	•	•	•	•	Cove & Bead	
CARRARA																
6'8" Hollow Core				•	•	•	•	•	•	•	•	•	•	•	Cove & Bead	•
6'8" Solid Core				•	•	•		•	•	•	•	•	•	•	Cove & Bead	•
7'0" Solid Core					•			•		•	•	•	•	•	Cove & Bead	
8'0" Hollow & Solid Core					•			•		•	•	•	•	•	Cove & Bead	
COLONIST																
6'8" Hollow Core	•	•	•	•	•	•	•	•	•	•	•	•	•	•	Cove & Bead	•
6'8" Solid Core					•	•		•	•	•	•	•	•	•	Cove & Bead	•
CONMORE																
6'8" Hollow Core					•			•		•	•	•	•	•	Stepped	•
6'8" Solid Core					•			•		•	•	•	•	•	Stepped	
CRAFTSMAN																
6'8" Hollow Core				•	•	•	•	•	•	•	•	•	•	•	Craftsman	•
6'8" Solid Core					•			•		•	•	•	•	•	Craftsman	
MADISON																
6'8" Hollow Core				•	•	•	•	•	•	•	•	•	•	•	Craftsman	•
6'8" Solid Core					•			•		•	•	•	•	•	Craftsman	
8'0" Solid Core					•			•		•	•	•	•	•	Craftsman	
MONROE																
6'8" Hollow Core				•	•	•	•	•	•	•	•	•	•	•	Craftsman	•
6'8" Solid Core					•			•		•	•	•	•	•	Craftsman	
8'0" Solid Core					•			•		•	•	•	•	•	Craftsman	
PRINCETON																
6'8" Hollow Core					•			•		•	•	•	•	•	Cove & Bead	•
6'8" Solid Core					•			•		•	•	•	•	•	Cove & Bead	
ROCKPORT																
6'8" Hollow Core				•	•	•		•		•	•	•	•	•	Cove & Bead	•
6'8" Solid Core					•			•		•	•	•	•	•	Cove & Bead	
8'0" Hollow & Solid Core					•			•		•	•	•	•	•	Cove & Bead	
SANTA FE																
6'8" Hollow Core				•	•	•	•	•	•	•	•	•	•	•	Ovolo	•
6'8" Solid Core					•			•		•	•	•	•	•	Ovolo	
SMOOTH COLONIST																
6'8" Hollow Core	•	•	•	•	•	•	•	•	•	•	•	•	•	•	Cove & Bead	•
6'8" Solid Core					•			•		•	•	•	•	•	Cove & Bead	•
COLONIST/IMPRESSIONS MIRROR																
6'8" Hollow Core								•		•	•	•	•	•	Cove & Bead	

• = Stocked

HOLLOW & SOLID CORE MOLDED DOORS

6/8 Doors

Hollow Core



Smooth Surface
BIRKDALE
Craftsman
Sticking
3 Flat Panel



Smooth Surface
CAIMAN
Cove & Bead
Sticking
2 Panel
Arch Top



Grained Surface
CAMDEN
Cove & Bead
Sticking
2 Panel
Arch Top



Smooth Surface
CARRARA
Cove & Bead
Sticking
2 Panel



Grained Surface
COLONIST
Cove & Bead
Sticking
6 Panel



Grained Surface
TWO SIDED DOOR
Side A
COLONIST
Cove & Bead
Sticking
6 Panel



Grained Surface
Side B
IMPRESSIONS MIRROR
Cove & Bead
Sticking
1 Panel



Smooth Surface
CONMORE
Stepped
Sticking
5 Flat Panel

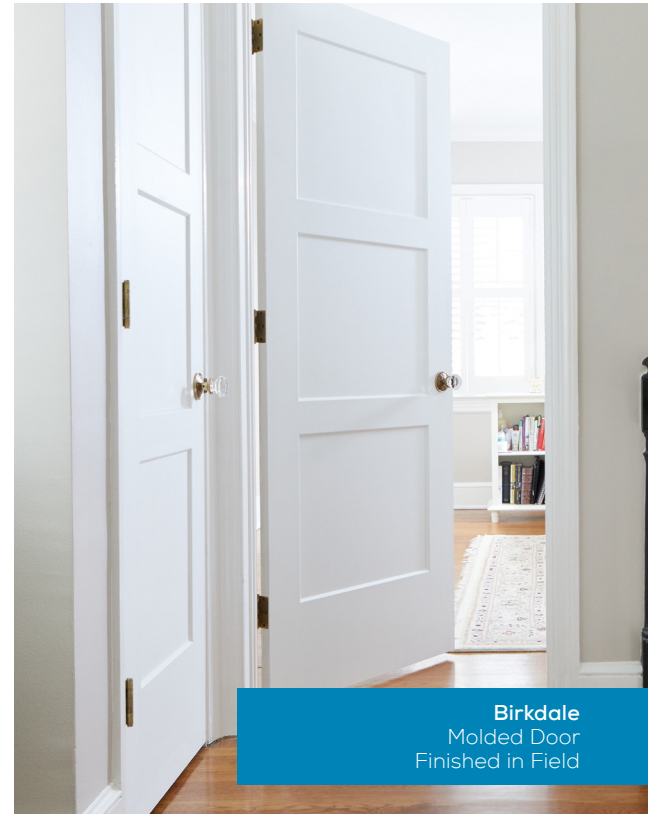

Birkdale
Molded Door
Finished in Field

STICKING PROFILES



Cove & Bead
Sticking



Craftsman
Sticking



Ovolo
Sticking



Stepped
Sticking

**Sticking profile denoted in door description*



Smooth Surface
CRAFTSMAN
Craftsman
Sticking
3 Flat Panel



Smooth Surface
MADISON
Craftsman
Sticking
1 Flat Panel



Smooth Surface
MONROE
Craftsman
Sticking
2 Flat Panel



Smooth Surface
PRINCETON
Cove & Bead
Sticking
2 Panel
Eyebrow

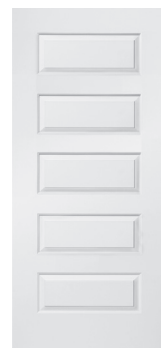

Smooth Surface
ROCKPORT
Cove & Bead
Sticking
5 Panel



Smooth Surface
SANTA FE
Ovolo
Sticking
2 Panel
Arch Top
Planked



Smooth Surface
SMOOTH COLONIST
Cove & Bead
Sticking
6 Panel

HOLLOW & SOLID CORE MOLDED DOORS

6/8 Doors

Solid Core



Smooth Surface
BIRKDALE
 Craftsman
 Sticking
 3 Flat Panel



Smooth Surface
CAIMAN
 Cove & Bead
 Sticking
 2 Panel
 Arch Top



Grained Surface
CAMDEN
 Cove & Bead
 Sticking
 2 Panel
 Eyebrow



Smooth Surface
CARRARA
 Cove & Bead
 Sticking
 2 Panel



Grained Surface
COLONIST
 Cove & Bead
 Sticking
 6 Panel



Smooth Surface
CONMORE
 Stepped
 Sticking
 5 Flat Panel



Smooth Surface
CRAFTSMAN
 Craftsman
 Sticking
 3 Flat Panel



Rockport
 Molded Door
 Finished in Field



Smooth Surface
MADISON
 Craftsman
 Sticking
 1 Flat Panel



Smooth Surface
MONROE
 Craftsman
 Sticking
 2 Flat Panel

PROCORE
 THE QUIET DOOR™

Consider upgrading to our *solid core doors* that provide more than just warmth and good looks. **ProCore™** doors reduce noise transmission by 50%, compared to hollow core doors.



Smooth Surface
PRINCETON
 Cove & Bead
 Sticking
 2 Panel
 Eyebrow



Smooth Surface
ROCKPORT
 Cove & Bead
 Sticking
 5 Panel



Smooth Surface
SANTA FE
 Ovolo
 Sticking
 2 Panel
 Arch Top
 Planked



Smooth Surface
SMOOTH COLONIST
 Cove & Bead
 Sticking
 6 Panel

HOLLOW & SOLID CORE MOLDED DOORS

7/0 Doors Solid Core



Smooth Surface
CARRARA
Cove & Bead
Sticking
2 Panel

8/0 Doors Hollow Core



Smooth Surface
CAIMAN
Cove & Bead
Sticking
2 Panel
Arch Top



Smooth Surface
CARRARA
Cove & Bead
Sticking
2 Panel



Smooth Surface
ROCKPORT
Cove & Bead
Sticking
6 Panel

8/0 Doors Solid Core



Smooth Surface
CAIMAN
Cove & Bead
Sticking
2 Panel
Arch Top



Smooth Surface
CARRARA
Cove & Bead
Sticking
2 Panel



Smooth Surface
MADISON
Craftsman
Sticking
1 Flat Panel



Smooth Surface
MONROE
Craftsman
Sticking
2 Flat Panel



Smooth Surface
ROCKPORT
Cove & Bead
Sticking
6 Panel



Monroe
Molded Door
Finished in Field

STICKING PROFILES



Cove & Bead
Sticking



Craftsman
Sticking



Ovolo
Sticking



Stepped
Sticking

**Sticking profile denoted in door description*

PROCORE
THE QUIET DOOR™

FRENCH DOORS

FRENCH DOORS

Enhance the beauty of any interior with our elegantly crafted line of French doors. They add elegance and privacy while maintaining brightness from one room to the next. French doors have tempered glass for extra strength and safety. Most feature a unique glass wrap that makes staining and finishing a snap.



15 Lite True Divided
Pine French Door
Finished in Field

AVAILABLE 6/8, 7/0, & 8/0 FRENCH DOOR SIZES

DOOR MODEL	1'6"	2'0"	2'4"	2'6"	2'8"	2'10"	3'0"	STICKING PROFILE
5 LITE CLEAR								
6'8" Primed	•							Ovolo
6'8" Pine	•							Ovolo
6'8" Oak	*							Ovolo
1 LITE CLEAR								
6'8" Primed	•	•	•	•	•		•	Ovolo
8'0" Primed		•	•	•	•		•	Ovolo
6'8" Pine		•	•	•	•		•	Ovolo
6'8" Oak		*		*	*		*	Ovolo
1 LITE FROSTED								
6'8" Primed		•	•	•	•		•	Ovolo
6'8" Primed		•	•	•	•		•	Shaker
8'0" Primed		•	•	•	•		•	Shaker
10 LITE CLEAR								
6'8" Primed		•	•	•			•	Ovolo
6'8" Pine		•	•	•	•		•	Ovolo
6'8" Pine V-Groove		*						Ovolo
6'8" Oak		*						Ovolo
15 LITE CLEAR								
6'8" Primed			•	•	•	•	•	Ovolo
7'0" Primed							•	Ovolo
6'8" Pine			•	•	•		•	Ovolo
6'8" Pine V-Groove			*	*	*		*	Ovolo
6'8" Oak			*	*	*		*	Ovolo
9 LITE CLEAR								
6'8" Primed		•		•			•	Ovolo
1 LITE PANTRY								
6'8" Primed		•	•	•	•			Ovolo
6'8" Pine		•	•	•	•			Ovolo
3 LITE FROSTED								
6'8" Primed		•	•	•	•		•	Shaker
8'0" Primed		•	•	•	•		•	Shaker
5 LITE FROSTED								
6'8" Primed		•	•	•	•		•	Shaker
8'0" Primed		•	•	•	•		•	Shaker
12 LITE CLEAR								
8'0" Primed		•	•	•	•		•	Ovolo
8'0" Pine		•	•	•	•		•	Ovolo
18 LITE CLEAR								
8'0" Primed				•	•		•	Ovolo

• = Stocked * = Available as Special Order

STICKING PROFILES



Ovolo
Sticking



Shaker
Sticking

*Sticking profile denoted in door description

FRENCH DOORS

6/8 Doors

Primed

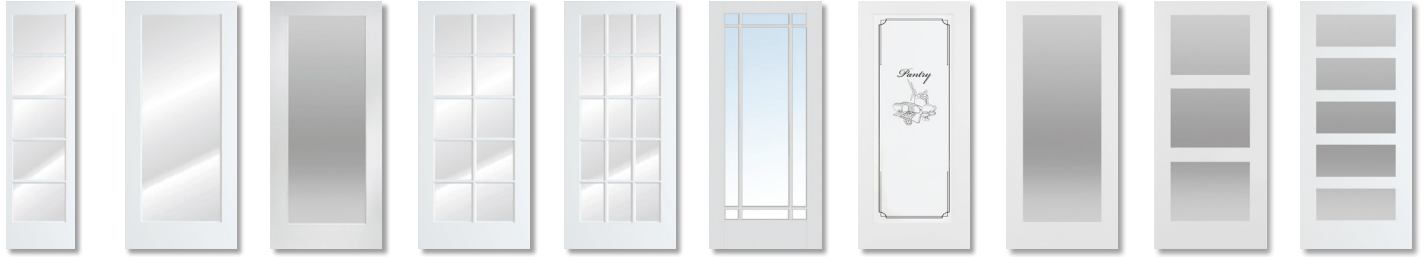

- | | | | | | | | | | |
|---|---|--|--|--|---|--|--|--|--|
| 5 LITE CLEAR
True Divided
Ovolo
Tempered
Glass | 1 LITE CLEAR
Ovolo
Tempered
Glass | 1 LITE FROSTED
Obscure
Ovolo
Tempered
Glass | 10 LITE CLEAR
True Divided
Ovolo
Tempered
Glass | 15 LITE CLEAR
True Divided
Ovolo
Tempered
Glass | 9 LITE CLEAR
True Divided
Ovolo
Tempered
Glass | 1 LITE PANTRY*
Obscure
Ovolo
Tempered
Glass | 1 LITE FROSTED
Shaker
Tempered
Glass | 3 LITE FROSTED
Shaker
Tempered
Glass | 5 LITE FROSTED
Shaker
Tempered
Glass |
|---|---|--|--|--|---|--|--|--|--|

Pine



- | | | | | | | |
|---|---|--|--|---|---|---|
| 5 LITE CLEAR
True Divided
Ovolo
Tempered
Glass | 1 LITE CLEAR
Ovolo
Tempered
Glass | 10 LITE CLEAR
True Divided
Ovolo
Tempered
Glass | 15 LITE CLEAR
True Divided
Ovolo
Tempered
Glass | 10 LITE CLEAR*
V-Groove
Ovolo
Tempered
Glass | 15 LITE CLEAR*
V-Groove
Ovolo
Tempered
Glass | 1 LITE PANTRY
Obscure
Ovolo
Tempered
Glass |
|---|---|--|--|---|---|---|

Oak



- | | | | |
|--|--|---|---|
| 5 LITE CLEAR*
True Divided
Ovolo
Tempered
Glass | 1 LITE CLEAR*
Ovolo
Tempered
Glass | 10 LITE CLEAR*
True Divided
Ovolo
Tempered
Glass | 15 LITE CLEAR*
True Divided
Ovolo
Tempered
Glass |
|--|--|---|---|

*Available as Special Order

7/0 Doors

Primed



- 15 LITE CLEAR**
True Divided
Ovolo
Tempered
Glass

8/0 Doors

Primed



- | | | | | | |
|---|--|--|--|--|--|
| 1 LITE CLEAR
Ovolo
Tempered
Glass | 12 LITE CLEAR
True Divided
Ovolo
Tempered
Glass | 18 LITE CLEAR
True Divided
Ovolo
Tempered
Glass | 1 LITE FROSTED
Shaker
Tempered
Glass | 3 LITE FROSTED
Shaker
Tempered
Glass | 5 LITE FROSTED
Shaker
Tempered
Glass |
|---|--|--|--|--|--|

Pine



- 12 LITE CLEAR**
True Divided
Ovolo
Tempered
Glass

PRIMED SHAKER FLAT PANEL DOORS

PRIMED SHAKER FLAT PANEL DOORS

Our primed shaker flat panel doors are manufactured to eliminate warp, panel shifting and rattling so your shaker door performs properly for years to come.



6/8 Doors

Primed



1 PANEL

2 PANEL

1 + 2 PANEL

3 PANEL
EQUAL

5 PANEL
EQUAL

8/0 Doors

Primed



1 PANEL

2 PANEL

1 + 2 PANEL

3 PANEL
EQUAL

5 PANEL
EQUAL

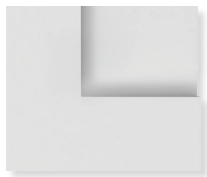

Shaker
Sticking



Superior priming –
four coats with sanding
between coats

AVAILABLE 6/8 & 8/0 PRIMED SHAKER FLAT PANEL DOORS

DOOR MODEL	1'6"	1'8"	2'0"	2'4"	2'6"	2'8"	2'10"	3'0"	STICKING PROFILE	BI-FOLDS
1 PANEL										
6'8" Primed	•	•	•	•	•	•	•	•	Shaker	•
8'0" Primed	•	•	•	•	•	•	•	•	Shaker	•
2 PANEL										
6'8" Primed	•	•	•	•	•	•	•	•	Shaker	•
8'0" Primed	•	•	•	•	•	•	•	•	Shaker	•
1 + 2 PANEL										
6'8" Primed	•	•	•	•	•	•	•	•	Shaker	•
8'0" Primed	•	•	•	•	•	•	•	•	Shaker	•
3 PANEL EQUAL										
6'8" Primed	•	•	•	•	•	•	•	•	Shaker	•
8'0" Primed	•	•	•	•	•	•	•	•	Shaker	•
5 PANEL EQUAL										
6'8" Primed	•	•	•	•	•	•	•	•	Shaker	•
8'0" Primed	•	•	•	•	•	•	•	•	Shaker	•

• = Stocked

PANEL AND LOUVER DOORS

PANEL DOORS

Traditional and timeless solid wood panel doors are designed to fit any décor where the richness of wood adds warmth to every room.

6/8 Doors

Pine



4 PANEL



6 PANEL

Oak



6 PANEL



6 Panel
Oak Panel Door
Finished in Field

AVAILABLE 6/8 PANEL DOORS

DOOR MODEL	1'0"	1'2"	1'3"	1'4"	1'6"	1'8"	1'10"	2'0"	2'2"	2'4"	2'6"	2'8"	2'10"	3'0"	STICKING PROFILE	BI-FOLDS
4 PANEL																
6'8" Pine					•			•		•	•	•			Ovolo	•
6 PANEL																
6'8" Pine	•	•	•	•	•	•	•	•	•	•	•	•	•	•	Ovolo	•
6'8" Oak	•	•	•	•	•	•	•	•	•	•	•	•	•	•	Ovolo	•

• = Stocked



Full Louver
Primed Louver Door
Finished in Field

LOUVER DOORS

6/8 Doors

Primed



FULL
LOUVER

Pine



FULL
LOUVER



HALF
LOUVER

* Louver direction is down

AVAILABLE 6/8 LOUVER DOORS

DOOR MODEL	1'2"	1'3"	1'4"	1'6"	1'8"	1'10"	2'0"	2'2"	2'4"	2'6"	2'8"	2'10"	3'0"	BI-FOLDS
FULL LOUVER														
6'8" Primed					•			•		•	•	•	•	•
6'8" Pine	•	•	•	•	•	•	•	•	•	•	•	•	•	•
HALF LOUVER														
6'8" Pine					•			•		•	•	•	•	•

• = Stocked

FLUSH & PREFINISHED DOORS

FLUSH & PREFINISHED EMBOSSED DOORS

Flush Doors

Made with select raw materials that are precisely machined and assembled for a beautiful, reliable door. These economical doors are dependable and will last for years to come.



PRIMED
HARDBOARD



BIRCH



RED OAK

Note: Available in Hollow and Solid core & 1-3/8" and 1-3/4" thick flush doors



Birch
Solid Core Flush Door
Finished in Field

Prefinished Embossed Hardboard Doors

Our hardboard doors are a simple solution for a quick, no hassle installation of new interior doors to your home. Prefinished and ready to be installed is a real advantage.



IMPERIAL
OAK

See page 21 for jamb options

AVAILABLE 6/8 & 7/0 FLUSH DOORS																
DOOR MODEL	1'0"	1'2"	1'3"	1'4"	1'6"	1'8"	1'10"	2'0"	2'2"	2'4"	2'6"	2'8"	2'10"	3'0"	3'6"	BI-FOLDS
PRIMED HARDBOARD																
6'8" Hollow Core	•	•	•	•	•	•	•	•	•	•	•	•	•	•	•	•
8'0" Hollow Core																
6'8" Solid Core					•			•		•	•	•	•	•		
7'0" Solid Core											•	•	•	•		
BIRCH																
6'8" Hollow Core	•	•	•	•	•	•	•	•	•	•	•	•	•	•	•	•
7'0" Hollow Core																
6'8" Solid Core					•			•	•	•	•	•	•	•	•	
7'0" Solid Core											•	•	•	•		
RED OAK																
6'8" Hollow Core				•	•	•	•	•	•	•	•	•	•	•	•	•
6'8" Solid Core					•			•		•	•	•	•	•		
7'0" Solid Core											•	•	•	•		
AVAILABLE 6/8 PREFINISHED EMBOSSED DOORS																
DOOR MODEL	1'0"	1'2"	1'3"	1'4"	1'6"	1'8"	1'10"	2'0"	2'2"	2'4"	2'6"	2'8"	2'10"	3'0"	3'6"	BI-FOLDS
IMPERIAL OAK																
6'8" Hollow Core					•			•	•	•	•	•	•	•	•	•
6'8" Solid Core														•		

• = Stocked

LITES & LOUVERS

LITES & LOUVERS

Revolutionize your Flush door with the below lites and louvers to add functional appeal.



20" x 24"



24" x 36"



10" x 10"



10" x 10"



4" x 24"



6" x 36"



20" x 12"
20" x 24"



20" x 12"
Flush Louver Door
Finished in Field

7/0 BARN DOORS

Combining both style and practicality, barn doors are a fresh and unique take on a traditional and timeless look.

PRODUCT DESCRIPTION

- Ideal for openings 28" - 42" wide
- Unique barn door style hardware enables the door to slide parallel to the wall
- Primed for field finishing
- Barn door hardware kits are also available to be sold separately



Frosted 3 Lite
Primed Barn Door
Finished in Field

* MMI stocked doors all weigh under the limit of 250lbs for hardware support



Primed
FROSTED 3 LITE

Primed
FROSTED 4 LITE

Primed
15 LITE

Primed
CARRARA

Primed
K BAR PLANKED

Primed
Z BAR PLANKED

K and Z Bar Planked:

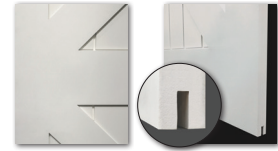

Frosted 3 and 4 Lite:

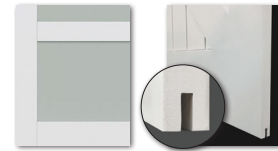

Stile and Rail Construction
Smooth Surface
Pre-Routed Door Bottom

Carrara:



Solid Core
Smooth Surface
Cove & Bead Sticking

AVAILABLE 1-3/8" 7/0 BARN DOORS									
DOOR MODEL	1'6"	2'0"	2'4"	2'6"	2'8"	2'10"	3'0"	3'6"	STICKING PROFILE
3 LITE FROSTED									
7'0" Primed							•	•	Shaker
4 LITE FROSTED									
7'0" Primed							•	•	Shaker
15 LITE CLEAR									
7'0" Primed							•		Ovolo
CARRARA									
7'0" Primed	•	•	•	•	•	•	•	•	Cove & Bead
K BAR PLANKED									
7'0" Primed							•	•	Shaker
Z BAR PLANKED									
7'0" Primed							•	•	Shaker

• = Stocked



Ovolo
Sticking



Shaker
Sticking

WALL-MOUNTED BARN DOOR HARDWARE KITS



K Bar Planked
Primed Barn Door
Finished in Field

A traditional system is redefined with contemporary styles and finishes to complement the home, office space or any opening space imaginable. Includes instructions that make it easy for "Do It Yourself" customers.

PRODUCT DESCRIPTION

- Hardware kits support 1-3/8" and 1-3/4" thick doors weighing up to 250 lbs*
- Kits available in 78-3/4" and 90" track lengths and also includes: door straps, wall spacer, safety anti-jump block, floor guide, and all hardware
- 78-3/4" track is ideal for openings/doors up to 36" wide
- 90" track is ideal for openings/doors between 36" - 42" wide
- Available in three factory finishes ready to install: Matte Black, Brushed Steel and Oil Rubbed Bronze
- Unique barn door style hardware enables the door to slide parallel to the wall, with one inch offset
- Use for closets, room dividers or passage door applications
- Available accessories: Track joiner for bi-parting door application, door handle, and recessed door pull
- Special hardware is available. Ask your sales person

* MMI stocked doors all weigh under the limit of 250lbs

AVAILABLE FINISHES:



Oil Rubbed Bronze



Stainless Steel



Matte Black

AVAILABLE BARN DOOR KIT OPTIONS:



Matte Black shown

Top of Door Mount Kit



Oil Rubbed Bronze shown
Available in Matte Black, Oil Rubbed Bronze and Stainless Steel

Bent Strap Kit



Stainless Steel shown
Available in Matte Black, Oil Rubbed Bronze and Stainless Steel - BD450

Door Handle



Stainless Steel shown
Available in Matte Black, Oil Rubbed Bronze and Stainless Steel - BD460

Recessed Door Pull

AVAILABLE BARN DOOR KITS			
KITS	MATTE BLACK	STAINLESS STEEL	OIL RUBBED BRONZE
Top of Door Mount Kit - Track & Hardware 78-3/4" Track BD101K	•		
Top of Door Mount Kit - Track & Hardware 90" Track BD101K	•		
Bent Strap Mount Kit - Track & Hardware 78-3/4" Track BD102K	•	•	•
Bent Strap Mount Kit - Track & Hardware 90" Track BD102K	•	•	•

THE MILLENNIUM COLLECTION®

The Millennium Collection® consists of four distinct door products that each fit a specific demand in the world of design and construction. *Encore*, *Ovation*, *Infinity*, and *Bravo* Doors are manufactured of renewable composite wood fiber materials for stability and reliability. Our state-of-the-art process and environmentally friendly construction techniques mean endless flexibility for your architectural design. Below are some samples of our standard designs:



Encore ROUTER CARVED DOORS

- Dramatic raised panels or grooved options
- Traditional molding profiles
- Made in the USA by proud American craftsmen
- 152 Designs Available

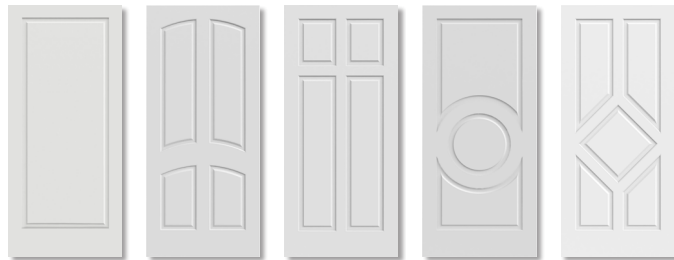

Ovation LAYERED PANEL DOORS

- Uniquely layered construction
- Environmentally friendly substrate that will not split or warp
- Made in the USA by proud American craftsmen
- 142 Standard Designs Available

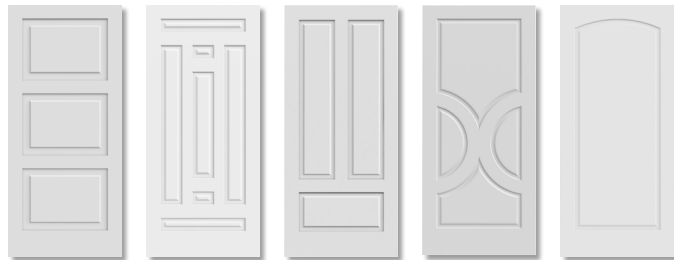

Infinity INLAID MOLDING DOORS

- Features dramatic raised panels
- Detailed inlaid molding profiles: Raised, Flush, and Plant-On
- Made in the USA by proud American craftsmen
- 138 Standard Designs Available



SPECIAL ORDER
Available in 3-6 Weeks

THE MILLENNIUM COLLECTION®

Bravo

TRADITIONAL STILE & RAIL DOORS

- Crisp detailed miters and profiles
- Architecturally correct panel configuration
- Made in the USA by proud American craftsmen
- 51 Traditional Designs Available

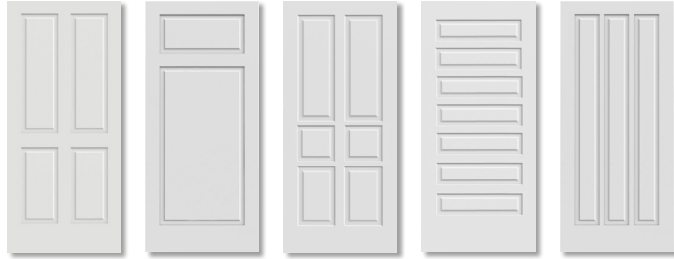

Below are more door styles we have to offer.

Styles shown in *Encore*®. Also available in *Ovation*®, *Infinity*®, and *Bravo*®

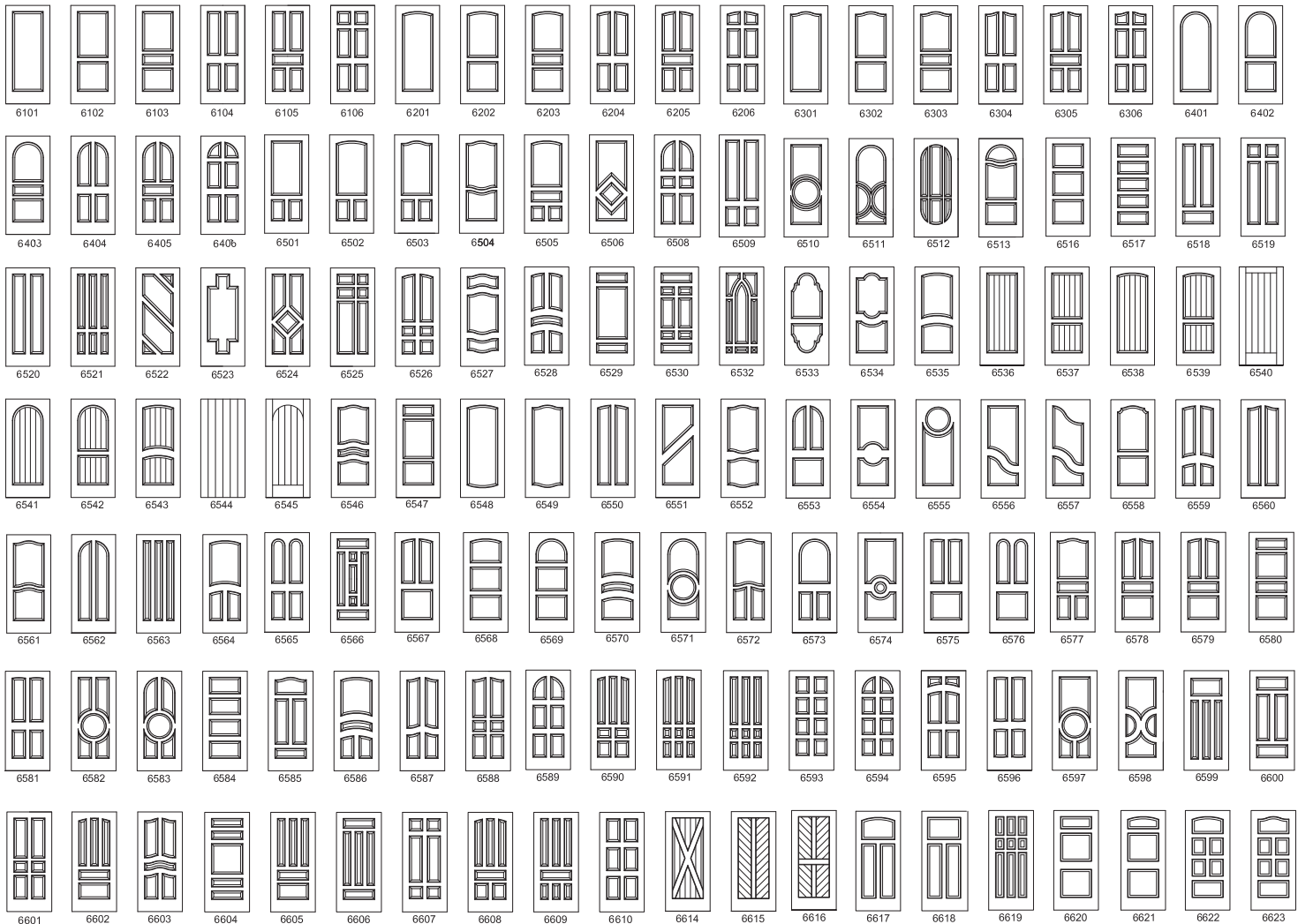

INTERIOR FIRE-RATED DOORS



Smooth Colonist
Fire-Rated Door
Finished in Field

20 MIN STANDARD 6/8 FIRE DOOR UNITS

FIRE RATING **20 MIN**

The Unit Includes:

- 4-9/16" primed wood exterior frame with applied brickmould & weatherstripping*
- Composite adjustable sill
- 20 Minute NAMI Fire Label
- 4" Satin Nickel Hinges applied



Although these door units are not designed to use exposed to the weather (See our Fiberglass Exterior Door Offering); you can perfectly match your interior molded doors with a fire code compliant "Garage-to-Home Entry Door!"

*Check local statutes for compliance

**Note: Available in select 3/0, 2/10, and 2/8 sizes

Molded Fire Door Units



Smooth Surface
BIRKDALE
Craftsman
Sticking
3 Flat Panel



Smooth Surface
CAIMAN
Cove & Bead
Sticking
2 Panel
Arch Top



Smooth Surface
CARRARA
Cove & Bead
Sticking
2 Panel



Smooth Surface
CRAFTSMAN
Craftsman
Sticking
3 Flat Panel



Smooth Surface
CONMORE
Stepped
Sticking
5 Flat Panel



Smooth Surface
ROCKPORT
Cove & Bead
Sticking
5 Panel



Smooth Surface
SANTA FE
Ovolo
Sticking
2 Panel
Arch Top
Planked



Smooth Surface
SMOOTH COLONIST*
Cove & Bead
Sticking
6 Panel
(Only Available in 3/0 x 6/8)

20 MIN MILLENNIUM FIRE DOOR UNITS

FIRE RATING **20 MIN**



1 PANEL



2 PANEL



3 PANEL
CRAFTSMAN



3 PANEL
EQUAL



5 PANEL
EQUAL

- Fire-rated doors are 1-3/4" thick
- Stocked in 2/8 & 3/0 widths in 6/8 heights

- Millennium fire-rated doors are also available in 45 and 90 MIN configurations
- Additional special order options available
- Available in 2/8, 2/10, & 3/0 widths in 7/0 & 8/0 heights

*Available as Special Order



3 Panel Equal
20 MIN Fire Door
Finished in Field

Codes vary by community. Homeowner must confirm specification requirements. All 90 MIN doors come with steel frames. Call for options!

ENTRY FIRE-RATED DOORS

20 MIN FIBERGLASS SMOOTH FIRE DOORS ON 20 MIN WOOD FRAMES

FIRE RATING **20 MIN**



FS 20 FIBERGLASS SMOOTH 2 Panel	FS 21 FIBERGLASS SMOOTH 6 Panel	FS 22 FIBERGLASS SMOOTH 2 Panel	FS 200 FIBERGLASS SMOOTH 2 Panel Planked	FS 10 SHK FIBERGLASS SMOOTH 1 Panel Craftsman	FS 20 SHK FIBERGLASS SMOOTH 2 Panel Craftsman	FS 30 SHK FIBERGLASS SMOOTH 3 Panel Craftsman
---	---	---	---	--	--	--

Note: Available in select 3/0 and 2/8 sizes

90 MIN FIRE DOORS ON STEEL FRAMES

FIRE RATING **90 MIN**



MAJESTIC STEEL MJ-1-90M	MAJESTIC STEEL MJ-20-90M	MAJESTIC STEEL MJ-21-90M	MAJESTIC STEEL MJ-22-90M	MAJESTIC STEEL MJ-40-90M
---------------------------------------	--	--	--	--



10 CRF 90M MAJESTIC STEEL 1 Panel	20 CRF 90M MAJESTIC STEEL 2 Panel	30 CRF 90M MAJESTIC STEEL 3 Panel
---	---	---



30 CRF 90M
Majestic Steel
Shown in Brilliant White

Note: Available in select 3/0, 2/10, and 2/8 sizes

Codes vary by community. Homeowner must confirm specification requirements. All 90 MIN doors come with steel frames. Call for options!

COMMERCIAL DOORS & HARDWARE

20 MIN & 90 MIN COMMERCIAL & RESIDENTIAL FLUSH DOORS

FIRE RATING **20 MIN**

FIRE RATING **90 MIN**

Unfinished & Prefinished Doors

* Available in 20 MIN, 45 MIN, and 90 MIN configurations

								
<i>Unfinished</i>	<i>Unfinished</i>	<i>Unfinished</i>	<i>Unfinished</i>	<i>Unfinished</i>	<i>Prefinished</i>	<i>Prefinished</i>	<i>Prefinished</i>	<i>Prefinished</i>
ROTARY NATURAL BIRCH*	ECONOMY BIRCH	PLAIN SLICED RED OAK*	QUARTER SLICED AFRICAN MAHOAGANY	PLAIN SLICED WHITE MAPLE*	PLAIN SLICED RED OAK	PLAIN SLICED WHITE MAPLE	COLLEDGE- GUARD	PRIMED HARDBOARD

Note: Available in select 3/6, 3/0, 2/10, and 2/8 sizes.

Not all flush doors are available in 20M and 90M. Check for availability.

Doors above are not 100% accurate in terms of grain and color

Codes vary by community. Homeowner must confirm specification requirements. All 90 MIN doors come with steel frames. Call for options!

COMMERCIAL HARDWARE (INTERIOR & EXTERIOR APPLICATION)

MMI DOOR stocks a full line of commercial doors, frames and hardware available for immediate delivery. We offer a variety of commercial hardware such as self closing hinges, automatic door closers, panic devices and more to suit most applications.



SLIDING DOOR POCKETS & HARDWARE

SLIDING DOOR POCKETS

Boxed Unit Frame - Unassembled

- Available in 3/0 x 6/8 (door sizes up to) FPD3068KD Universal Frame and Hardware
- 3/0 x 8/0 (door sizes up to) FPD3080KD Universal Frame and Hardware
- Mullion Kit PD118P (Joins 2 kits together for double door opening)

Features

- Carton packaged - easy storage and handling
- Steel stiffener reinforcement frame
- Door thickness of 1-3/8" or 1-3/4" and weight up to 125 lbs.
- Four wheel roller on v-groove jump proof track
- Easy adjustment after installation
- Cut marks for easy sizing to standard door widths

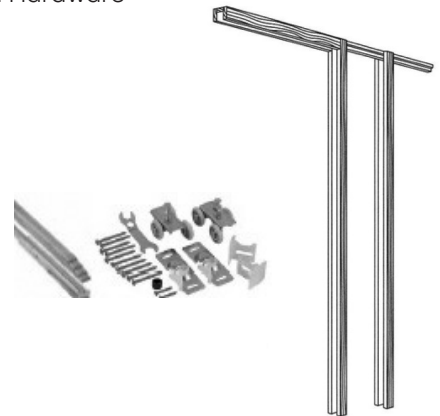

ROUGH OPENING FOR K.D. BOXED FRAME		
DOOR SIZE	6/8 HEIGHT	8/0 HEIGHT
2/0	49-1/4" x 84-1/2"	49-1/4" x 100-1/2"
2/4	57-1/4" x 84-1/2"	57-1/4" x 100-1/2"
2/6	61-1/4" x 84-1/2"	61-1/4" x 100-1/2"
2/8	65-1/4" x 84-1/2"	65-1/4" x 100-1/2"
3/0	73-1/4" x 84-1/2"	73-1/4" x 100-1/2"

Built Up Frame

Features

- Built up wood frame for easy installation
- Door thickness of 1-3/8" and weight up to 125 lbs.
- Four wheel roller on v-groove jump proof track
- Easy adjustment after installation

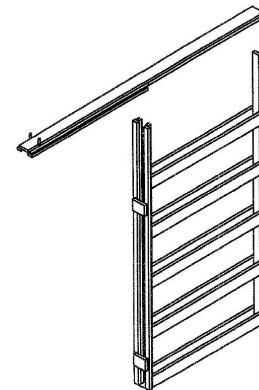

ROUGH OPENING FOR BUILT UP FRAME	
DOOR SIZE	6/8 HEIGHT
2/0	50" x 85"
2/4	58" x 85"
2/6	62" x 85"
2/8	66" x 85"
3/0	74" x 85"

Note: Call for Bypass and Bi-folds rough openings

BYPASS TRACK AND HARDWARE

#2200

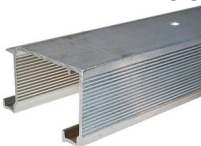

- 4/0 Aluminum #2200 Track and Hardware
- 5/0 Aluminum #2200 Track and Hardware
- 6/0 Aluminum #2200 Track and Hardware

#2222



- 4/0 Aluminum #2222 Track with Hardware*
- 5/0 Aluminum #2222 Track with Hardware*
- 6/0 Aluminum #2222 Track with Hardware*

* Note: In stock in OH only. Special order in MI and PA.

#2200F

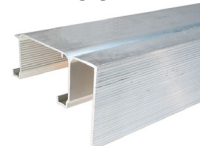







- 4/0 Aluminum #2200F Track with Hardware
- 5/0 Aluminum #2200F Track with Hardware
- 6/0 Aluminum #2200F Track with Hardware

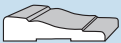

OPTIONS

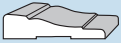
SINGLE DOOR PREHUNG JAMB OPTION:		PRIMED		PINE VENEER WOOD BACK		OAK VENEER WOOD BACK		PREFINISHED EMBOSSED	
		Single	Double	Single	Double	Single	Double	Single	Double
4-9/16" Primed	6/8 Unit	*	*	*	*	*	*	*	*
4-9/16" Primed	7/0 Unit	*	*	*	*	*	*	*	*
4-9/16" Primed	8/0 Unit	*	*	*	*	*	*	*	*
4-13/16" Primed	6/8 Unit	*	*	*	*	*	*	*	*
4-13/16" Primed	7/0 Unit	*	*	*	*	*	*	*	*
4-13/16" Primed	8/0 Unit	*	*	*	*	*	*	*	*
5-1/4" Primed	6/8 Unit	*	*	*	*	*	*	*	*
6-7/8" Primed	7/0 Unit	*	*	*	*	*	*	*	*
6-7/8" Primed	7/0 Unit	*	*	*	*	*	*	*	*
6-7/8" Primed	7/0 Unit	*	*	*	*	*	*	*	*
6-7/8" Primed	8/0 Unit	*	*	*	*	*	*	*	*
6-7/8" Primed	8/0 Unit	*	*	*	*	*	*	*	*
6-7/8" Primed	8/0 Unit	*	*	*	*	*	*	*	*
6-9/16" Primed	6/8 Unit	*	*	*	*	*	*	*	*
6-9/16" Primed	7/0 Unit	*	*	*	*	*	*	*	*
6-9/16" Primed	8/0 Unit	*	*	*	*	*	*	*	*
7-1/4" Primed	6/8 Unit	*	*	*	*	*	*	*	*
4-9/16" Pine Veneer Wood Back	6/8 Unit	*	*	*	*	*	*	*	*
4-9/16" Solid Pine	6/8 Unit	*	*	*	*	*	*	*	*
4-9/16" Solid Pine	7/0 Unit	*	*	*	*	*	*	*	*
4-9/16" Solid Pine	8/0 Unit	*	*	*	*	*	*	*	*
5-1/4" Solid Pine	6/8 Unit	*	*	*	*	*	*	*	*
5-1/4" Solid Pine	7/0 Unit	*	*	*	*	*	*	*	*
6-9/16" Solid Pine	6/8 Unit	*	*	*	*	*	*	*	*
7-1/4" Solid Pine	6/8 Unit	*	*	*	*	*	*	*	*
7-1/4" Solid Pine	7/0 Unit	*	*	*	*	*	*	*	*
7-1/4" Solid Pine	8/0 Unit	*	*	*	*	*	*	*	*
9-1/4" Solid Pine	6/8 Unit	*	*	*	*	*	*	*	*
9-1/4" Solid Pine	7/0 Unit	*	*	*	*	*	*	*	*
9-1/4" Solid Pine	8/0 Unit	*	*	*	*	*	*	*	*
11-1/4" Solid Pine	6/8 Unit	*	*	*	*	*	*	*	*
11-1/4" Solid Pine	7/0 Unit	*	*	*	*	*	*	*	*
11-1/4" Solid Pine	8/0 Unit	*	*	*	*	*	*	*	*
4-9/16" Solid Poplar	6/8 Unit	*	*	*	*	*	*	*	*
4-9/16" Solid Poplar	7/0 Unit	*	*	*	*	*	*	*	*
4-9/16" Solid Poplar	8/0 Unit	*	*	*	*	*	*	*	*
4-13/16" Solid Poplar	6/8 Unit	*	*	*	*	*	*	*	*
4-13/16" Solid Poplar	7/0 Unit	*	*	*	*	*	*	*	*
4-13/16" Solid Poplar	8/0 Unit	*	*	*	*	*	*	*	*
6-9/16" Solid Poplar	6/8 Unit	*	*	*	*	*	*	*	*
9-1/4" Solid Poplar	6/8 Unit	*	*	*	*	*	*	*	*
9-1/4" Solid Poplar	7/0 Unit	*	*	*	*	*	*	*	*
9-1/4" Solid Poplar	8/0 Unit	*	*	*	*	*	*	*	*
4-9/16" Oak Veneer Wood Back	6/8 Unit	*	*	*	*	*	*	*	*
4-9/16" Solid Oak	6/8 Unit	*	*	*	*	*	*	*	*
4-9/16" Solid Oak	7/0 Unit	*	*	*	*	*	*	*	*
4-9/16" Solid Oak	8/0 Unit	*	*	*	*	*	*	*	*
4-13/16" Solid Oak	6/8 Unit	*	*	*	*	*	*	*	*
4-13/16" Solid Oak	7/0 Unit	*	*	*	*	*	*	*	*
5-1/4" Solid Oak	6/8 Unit	*	*	*	*	*	*	*	*
5-1/4" Solid Oak	7/0 Unit	*	*	*	*	*	*	*	*
6-9/16" Solid Oak	6/8 Unit	*	*	*	*	*	*	*	*
7-1/4" Solid Oak	6/8 Unit	*	*	*	*	*	*	*	*
7-1/4" Solid Oak	7/0 Unit	*	*	*	*	*	*	*	*
9-1/4" Solid Oak	6/8 Unit	*	*	*	*	*	*	*	*
9-1/4" Solid Oak	7/0 Unit	*	*	*	*	*	*	*	*
4-9/16" PF Embossed Imperial Oak	6/8 Unit	*	*	*	*	*	*	*	*
4-13/16" PF Embossed Imperial Oak	6/8 Unit	*	*	*	*	*	*	*	*
4-1/4 - 4-3/4" Primed Split Jamb	6/8 Unit	*	*	*	*	*	*	*	*
4-1/4 - 4-3/4" Solid Pine Split Jamb	6/8 Unit	*	*	*	*	*	*	*	*
4-1/4 - 4-3/4" PF Emb. Imperial Oak Split Jamb	6/8 Unit	*	*	*	*	*	*	*	*

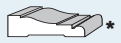
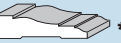
* = Stocked

CASED OPENINGS	
MITERED CASING SETS	
	11/16" x 2-1/4" 356 Imperial Oak Casing
	9/16" x 2-1/4" 356 Red Oak Casing
	11/16" x 2-1/4" 356 Primed MDF Casing
	11/16" x 2-1/4" 327 Pine Casing
	11/16" x 2-1/4" 356 Pine Casing
	11/16" x 2-1/4" 376 Pine Casing
	11/16" x 2-1/2" 361 Pine Casing
	11/16" x 3-1/4" 445 Pine Casing

	11/16" x 2-1/4" 327 Primed Casing
	11/16" x 2-1/4" 366 Primed Casing
	11/16" x 2-1/4" 356 Primed Casing
	11/16" x 2-1/4" 376 Primed Casing
	11/16" x 3-1/4" 445 Primed Casing
	11/16" x 3-1/4" 444 Primed Casing
	11/16" x 2-5/8" CM1 Primed Casing
	11/16" x 2-3/4" CM 299 Primed Casing
	11/16" x 3-1/2" CM 450 Primed Casing
	9/16" x 3-1/2" MDF CRF Casing
	11/16" x 3-1/2" WM 412 Primed R2E Casing for Craftsman and Shaker

*Varies by location

SPECIAL ORDER
Available in 3-6 Weeks

SPECIAL ORDER GLASS

GLASS OPTIONS

Crystal clear, frosted, semi-opaque, with or without decorative patterns – we offer over 20 types of glass. Choose the door and then select the glass that will make the door of your dreams complete. Below is a small sample of the glass type options available.



AUSTIN



BAMBOO



EVERGLADE



HAMMERED



MAYFLOWER



NARROW
REED



RAIN
NIAGARA



WARWICK



WATERGLASS



15 Lite True Divided
with Hammered Glass
Oak French Door
Finished in Field

CUSTOM ORDER DOORS

From panels created with personalized designs to custom sized doors, when it comes to special requests, it's clear the possibilities are endless. MMI DOOR will process your order quickly and efficiently so you get the door you expect and you get it on time.



Left: 1 lite - Knotty Alder
interior door with
"Rain Niagara" glass

SPECIFICATIONS

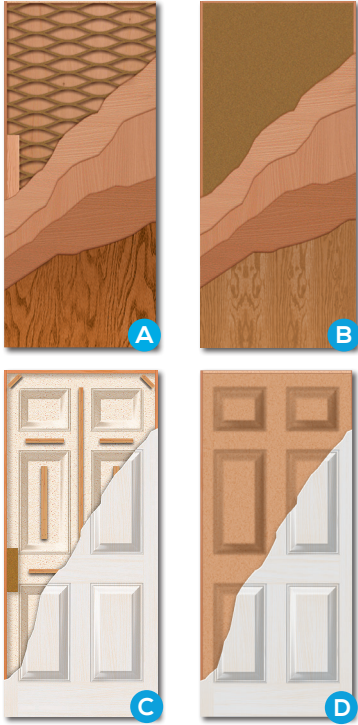

CORES, HANDINGS & ROUGH OPENINGS

Flush Door Cores:

- A. Hollow Core:**
- Combination Wood/MDF Frame
 - Corrugated honeycomb cell core
 - 1-5/32" MDF stiles - optional wood stiles
 - Optional wood top and bottom rails in customer specified widths
 - 1/8" premium hardwood veneers or pre-primed hardboard
- B. Solid Core:**
- Wood or MDF Frame
 - 1-5/32" MDF top & bottom rails
 - Optional wood top and bottom rails in customer specified widths
 - 1/8" premium hardwood veneers, pre-primed or unprimed hardboard

Molded Door Cores:

- C. Hollow Core:**
- MDF Frame
 - 1-5/32" MDF top & bottom rails
 - Blocking behind panels for support
 - Two particleboard lock blocks
 - Optional wood top and bottom rails in customer specified widths
- D. Solid Core:**
- Wood Frame
 - MDF top and bottom rails optional
 - 1/8" HDF facings
 - 1-1/4" wood top and bottom rails in customer specified widths

INSIDE EACH MILLENNIUM DOOR

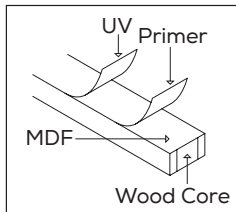

The Finish:

Each door is individually finished with a UV sealer system. Applied before the finishing coat, seals the wood, removing all traces of cracks and crevices in the joints and tones down brush strokes, knots and woodgrain

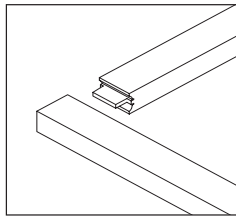

Tenon & Mortise Joint:

High quality construction with an adhesive binding technique that gives the joints exceptional strength and a lasting hold

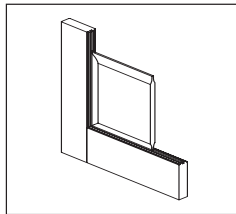

Panels:

Medium Density Fiber panels are incorporated in each panel for a stable door, resistant to expansion which helps to protect from cracks and leaks

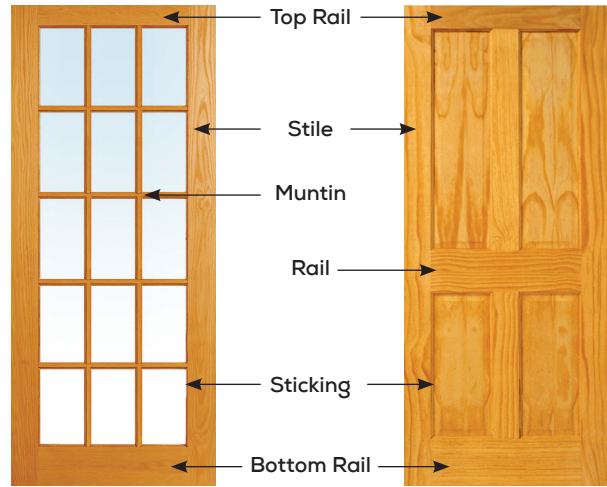

Interior Handings

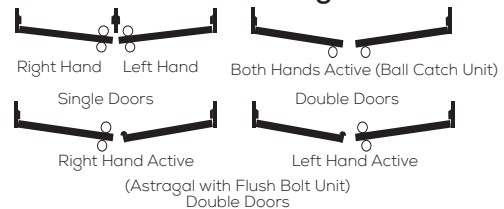

Door Openings

NOMINAL DOOR SIZE	SINGLE DOOR WIDTH						DOUBLE DOOR WIDTH*						HEIGHT	
	1/6	2/0	2/4	2/6	2/8	3/0	3/0	4/0	4/8	5/0	5/4	6/0	6/8	8/0
Rough Opening Required	20"	26"	30"	32"	34"	38"	38"	50"	58"	62"	66"	74"	82-1/4"	98-1/4"
Unit Dimension	19-1/2"	25-1/2"	29-1/2"	31-1/2"	33-1/2"	37-1/2"	37-1/2"	49-1/2"	57-1/2"	61-1/2"	65-1/2"	73-1/2"	81-1/2"	97-1/2"

*Double door unit dimensions shown are for units with ball catch only. For double door units with an astragal, add 1/2" to width.

CARE, FINISHING AND WARRANTIES

The care and finishing of your new interior doors should be taken very seriously. Though these suggestions may sound basic, most damage to interior doors is caused by improper, careless handling.

- Wood doors should be treated like fine wood furniture.
- Doors stored for more than a few days should have the top and bottom rails sealed. Do not drag doors or walk on them.
- Single door slabs (not prehung doors) should be laid flat on a dry, clean surface.
- Do not subject them to extreme or rapid changes in humidity or heat.

FINISHING

Proper care and finishing are very important to gain the maximum benefits from your interior doors. If done right, a correctly applied finish will help you achieve a longer lasting, higher quality product that exceeds your aesthetic and operational expectations. Below are a few key points everyone should know when it comes to the care and finishing of interior doors.

- All doors have six sides - not two, not four, but six – front, back, two edges, plus the most ignored and most vulnerable, the top and bottom. Failure to finish all six surfaces uniformly is the number one cause of door failures.
- No finishing process exists today that totally eliminates the transmission of water vapor or moisture into and out of wood doors. The key to proper finishing is to slow down the transmission process so the door performs within tolerances.
- Sanding is a critical component of any finishing process. All doors may have visible and invisible blemishes from handling or other natural occurring characteristics. Sanding techniques vary by door type and must be followed to achieve a quality finish.
- Natural wood doors (pine, poplar, oak, etc.) contain color, tone and graining variations that occur in the natural process. Application of a pre-stain wood conditioner promotes a uniform appearance and minimizes sharp color contrasts. Carefully follow manufacturer's instructions for wood conditioner application.
- Oil based products are recommended for interior wood veneered doors. Water based products can raise the grain and cause multiple moisture related problems. Latex or oil based paint is suitable for interior molded doors.

For more detailed information, please refer to the manufacturer's care, finishing and maintenance directions located on our website – www.mmidoor.com

WARRANTY

At MMI DOOR, interior doors are produced to exacting standards, regardless of the manufacturer. Based on decades of superior performance, we warrant our interior doors from defects in material or workmanship for a period of 5 years when they are:

- Properly installed
- Properly finished (paint or stain)
- Properly cared for and maintained



Madison
Molded Door
Finished in Field



5 Year
Limited Warranty

For more information on MMI DOOR
products and services, please visit:

www.mmidoor.com



MMI DOOR LOCATIONS

Michigan (HQ)

6361 Sterling Drive North
Sterling Heights, MI 48312
586.264.0950
800.686.9218
Fax: 586.264.5430

Ohio

400 Circle Freeway Drive
Cincinnati, OH 45246
513.874.6771
800.215.3770
Fax: 513.870.0242

Pennsylvania

172 Plummer Road
Sidman, PA 15955
814.487.7800
800.452.0251
Fax: 814.487.7850

© 2022 MMI DOOR All Rights Reserved.
MMIIDBROCH • 03/22

Caiman
Molded Door
Finished in Field

JW